

OLYMPUS[®]

DIGITAL CAMERA

FE-210/X-775

Advanced Manual

Quick Start Guide

Get started using your camera right away.

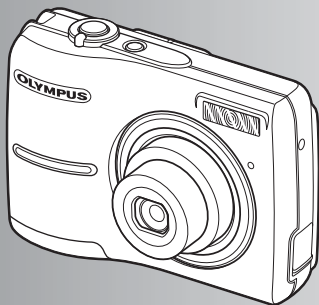

Button operations

Menu operations

Printing pictures

Using OLYMPUS Master

**Getting to know your
camera better**

Appendix

- Thank you for purchasing an Olympus digital camera. Before you start to use your new camera, please read these instructions carefully to enjoy optimum performance. Keep this manual in a safe place for future reference.
- We recommend that you take test shots to get accustomed to your camera before taking important photographs.
- In the interest of continually improving products, Olympus reserves the right to update or modify information contained in this manual.
- The screen and camera illustrations shown in this manual were produced during the development stages and may differ from the actual product.

Contents

Quick Start Guide P. 3

Button operations P. 10

Test out the functions of the camera buttons by following along with the illustrations

Menu operations P. 16

Learn about the menus that control the functions and settings for basic operation.

Printing pictures P. 28

Learn how to print pictures you have taken.

Using OLYMPUS Master P. 37

Learn how to transfer and save pictures to a computer.

Getting to know your camera better P. 45

Find out more about camera operations and how to take better pictures.

Appendix P. 54

Read about convenient functions and safety precautions on how to use your camera more effectively.

Gather these items (box contents)



Digital camera



Strap



AA batteries
(2)

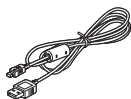

USB cable

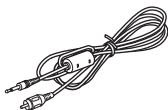

Video cable



OLYMPUS Master
CD-ROM

Other items

- Basic Manual
 - Advanced Manual (this manual)
 - Warranty card
- Contents may vary depending on purchase location.

Attach the strap

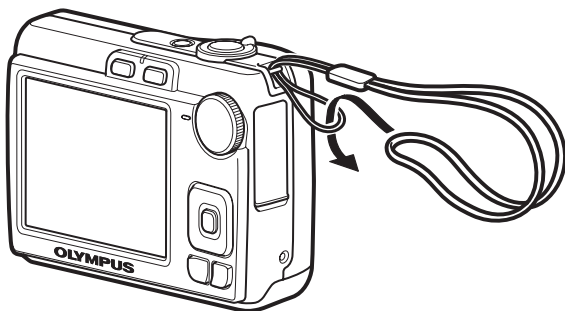

- Pull the strap tight so that it does not come loose.

Insert the batteries

a. Insert the batteries into the camera.

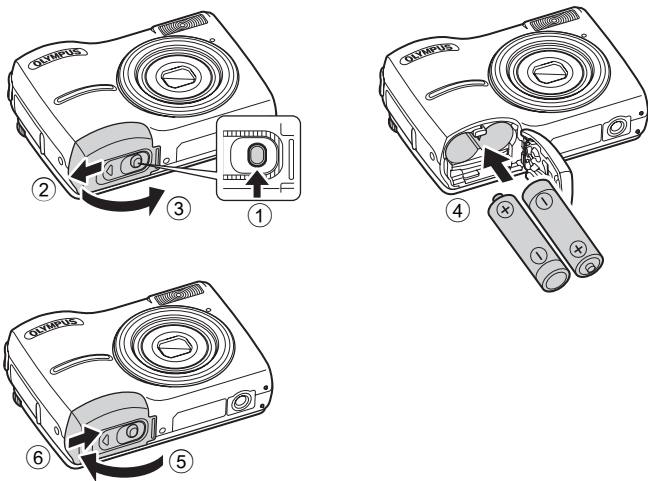

- Even when an optional xD-Picture Card™ (hereinafter called the card) is not inserted, you can take a picture. For details on inserting an optional card, please refer to “Inserting and removing the card” (P. 56).

Hint

The directions of the arrow pad ($\triangle \nabla \triangleleft \triangleright$) is indicated with $\triangle \nabla \triangleleft \triangleright$ in this manual.

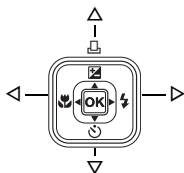

Turn the camera on

This explains how to turn on the camera in shooting mode.

a. Set the mode dial to **AUTO**.

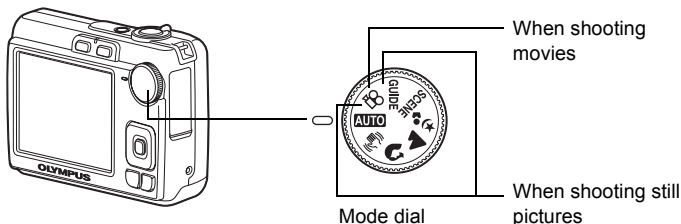

Still picture shooting modes

AUTO	This function allows you to shoot with the camera's automatic settings.
	This function stabilizes images when taking pictures.
	Suitable for taking pictures of people.
	Suitable for taking pictures of landscapes.
	Suitable for taking pictures of people at night.
SCENE	Select from 10 scene modes according to the shooting conditions.
GUIDE	Use the shooting guide displayed on the screen to shoot pictures according to the situation.

b. Press the **POWER** button.

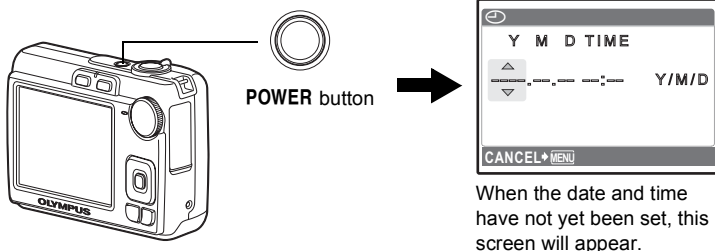

- To turn off the camera, press the **POWER** button once again.

Set date and time

About the date and time setting screen

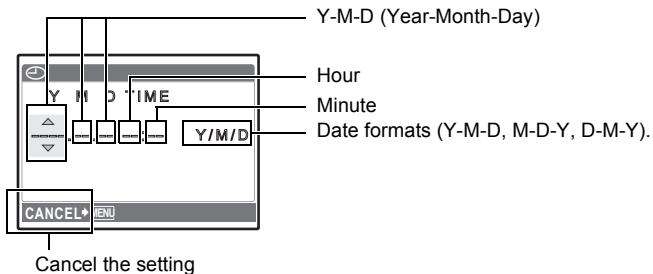

- a. Press the button and the button to select [Y].
- The first two digits of [Y] are fixed.

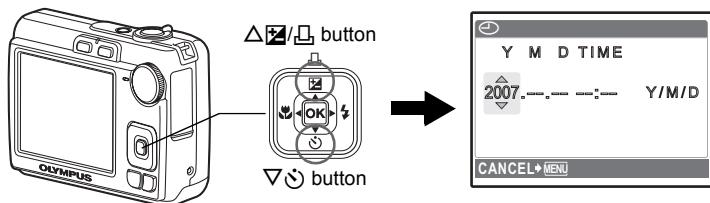

- b. Press the button.

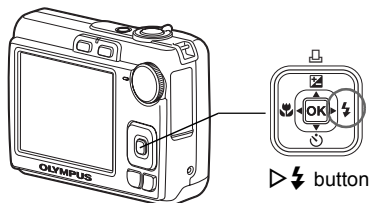



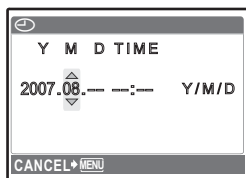

- c. Press the button and the button to select [M].

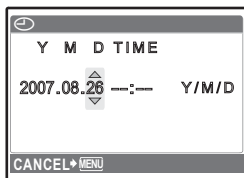

- d. Press the  button.
 e. Press the /  button and the  button to select [D].



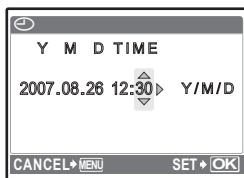

- f. Press the  button.
 g. Press the /  button and the  button to select “hour” and “minute”.
 ● The time is displayed in the 24-hour format.

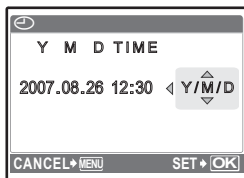

- h. Press the  button.
 i. Press the /  button and the  button to select [Y/M/D].



- j. After all items have been set, press the  button.
 ● For a more accurate setting, you can press the  button when the time signal hits 00 seconds.

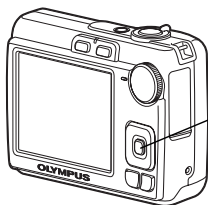

Take a picture

a. Hold the camera.

Horizontal grip

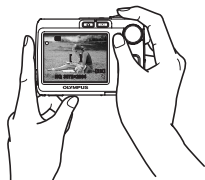
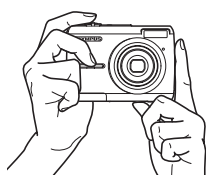

Vertical grip

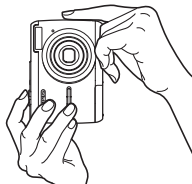

b. Focus.

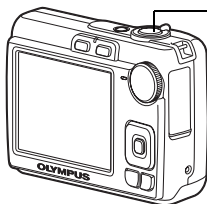

Shutter
button
Press
halfway



Place this mark over your subject.



The number of
remaining still pictures
is displayed.

The green lamp indicates the focus
and exposure are locked.

c. Shoot.

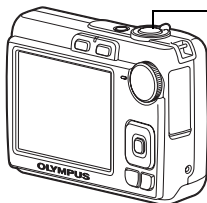

Shutter
button
Press
completely



The card access lamp blinks.



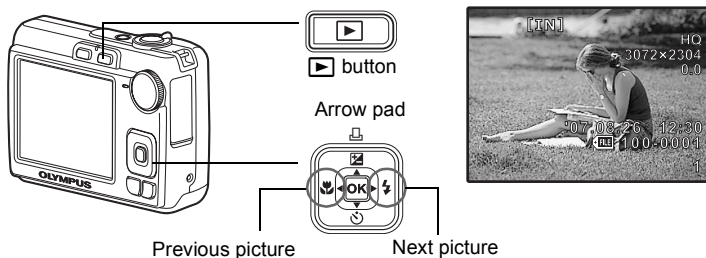

Review your pictures

- a. Press the  button.



Erase pictures

- a. Press the  button and the  button to display the picture you want to erase.
- b. Press the  button.

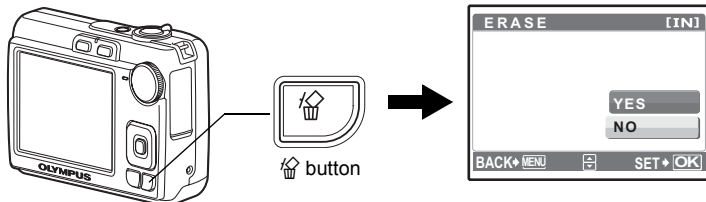

- c. Press the  button to select [YES] and press the  button.

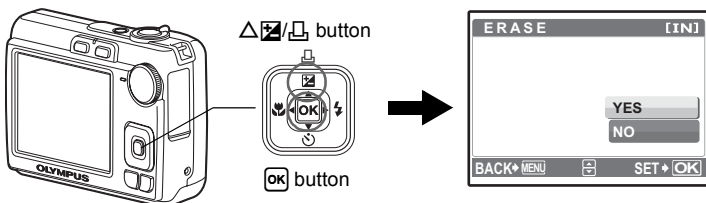

Button operations

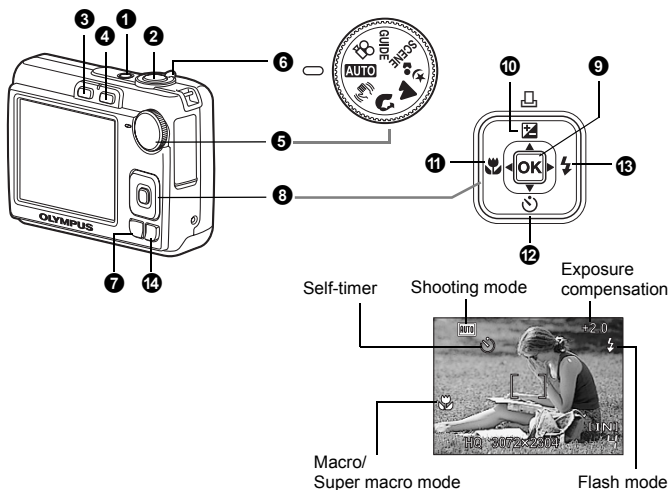

1 POWER button

Turning the camera on and off

Power on: Camera turns on in the shooting mode.

- Lens extends
- Monitor turns on

2 Shutter button

Shooting pictures

Shooting still pictures

Set the mode dial to anything except  and press the shutter button lightly (halfway). The green lamp lights when the focus and exposure are locked (focus lock). Now press the shutter button all the way (completely) to take the picture.

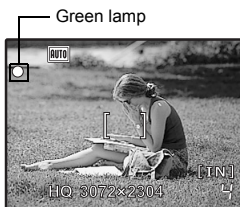

Locking the focus and then composing the shot (Focus lock)

Compose your picture with the focus locked, and then fully press the shutter button to shoot a picture.

- When the green lamp blinks, the focus is not adjusted properly. Try locking the focus again.

Recording movies

Set the mode dial to , and press the shutter button halfway to lock the focus. Press the shutter button completely to start recording, and press the shutter button again to stop recording.

3 button (Shooting) Selecting shooting mode/turning on the power

Switching to the shooting mode.

While the camera is off, it can be set to turn on in shooting mode when  is pressed.

 “/▶ Turning on the camera with the  or ▶ button” (P. 26)

4 ▶ button (Playback) Selecting playback mode/turning on the power

Switches to the playback mode and the last picture taken is displayed.

- Press the arrow pad to view other pictures.
- Use the zoom lever to switch among close-up playback and index display.
- Press **[OK]** to delete the information display shown for 3 seconds during single-frame playback.

While the camera is off, it can be set to turn on in playback mode when ▶ is pressed.

 “/▶ Turning on the camera with the  or ▶ button” (P. 26)

 “MOVIE PLAY Playing back movies” (P. 21)

5 Mode dial Switching between shooting modes

Set the mode dial to the desired shooting mode and shoot pictures.

- Press **[OK]** to delete the mode information display shown for 3 seconds when the mode dial is set to other than **SCENE** or **GUIDE**.

AUTO Shooting pictures with automatic settings

The camera determines the optimum settings for the shooting conditions automatically.

Shooting pictures with digital image stabilization

This function stabilizes the blur caused by a moving subject or camera movement when taking pictures.

, , Shooting pictures according to the situation

You can shoot pictures with the appropriate settings for portraits, landscapes, night and portrait.

SCENE Shoot pictures by selecting a scene mode according to the situation

You can shoot pictures by selecting from 10 types of scenes according to the situation. Press **OK** to confirm your selection.

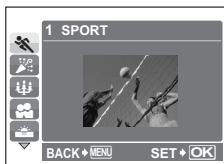
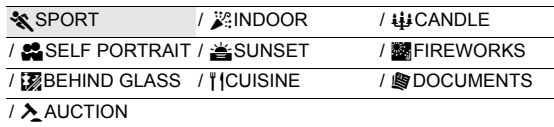

- The scene mode selection screen displays sample images as well as a description of the shooting situation for which it is designed.
- To switch scenes after selecting a scene, press **MENU** and select [**SCENE**] from the Top Menu. The selection screen is displayed.
- By switching to another scene, most settings will be changed to the default settings of each scene mode.

GUIDE Follow the shooting guide to take better pictures

This function allows you to set the target items by following the shooting guide displayed on the screen.

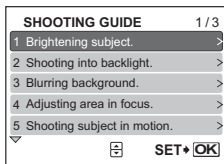

- Press **MENU** to display the shooting guide again.
- To change the setting without using the shooting guide, set the shooting mode to another one.
- The content set using the shooting guide will return to the default setting by pressing **MENU** or changing the mode using the mode dial.

Recording movies

Recording moving images. Sound is not recorded.

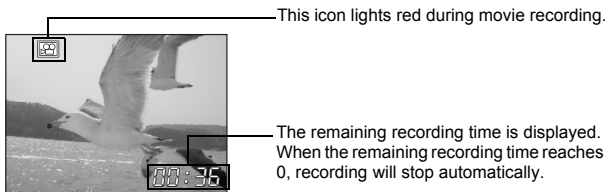

Shooting mode: Zooming in on your subject (Optical zoom x digital zoom: 12x)

Zoom out:

Turn the zoom lever to the **W** side.

Zoom in:

Turn the zoom lever to the **T** side.

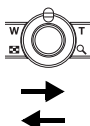

Zoom bar

White area:

Optical zoom area

Red area:

Digital zoom area

Playback mode: Changing the picture display

Single-frame playback

- Use the arrow pad to browse pictures.

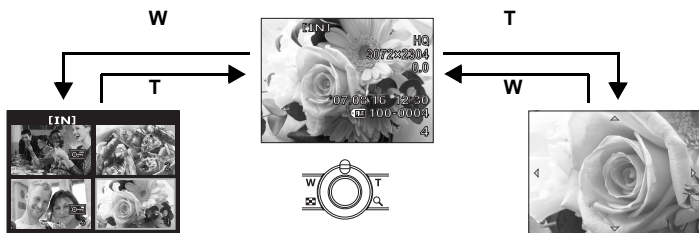

W ↓ ↑ T



W ↓ ↑ T



W ↓ ↑ T



W ↓ ↑ T

Index display

- Use the arrow pad to select a picture for playback, and press **[OK]** to play back the single-frame of the picture selected.

Close-up playback

- Turn and hold the zoom lever to the **T** side to enlarge the picture up to 10 times the original size. Turn to the **W** side to reduce the size.
- Use the arrow pad during close-up playback to scroll around the picture.
- Press **[OK]** to return to the single-frame playback.

7 MENU button

Displaying the menu

Displays the Top Menu.

8 Arrow pad (△▽◀▶)

Use the arrow pad to select scenes, playback picture, and the items on the menus.

9 OK button

This button is used to confirm your selection.

10 △/◻/◻ button

Changing picture brightness/Printing pictures

Shooting mode: Changing picture brightness

In shooting mode press △/◻/◻, set with ◀▶, then press OK.

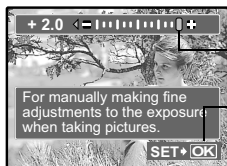

• Adjustable from - 2.0 EV to + 2.0 EV.

▶: Brightens.

◀: Darkens.

Activate the setting contents.

Playback mode: Printing pictures

Display a picture to print out in playback mode, connect the camera to the printer, and then press △/◻/◻ to print the picture.

☞ "Direct printing (PictBridge)" (P. 28)

11 ◀🌸 button



Shooting pictures close to the subject

Press ◀🌸 in shooting mode to select the macro mode.

Press OK to confirm your selection.

OFF	MACRO OFF	Macro mode is deactivated.
🌸	MACRO	This mode lets you shoot as close as 10 cm/3.9 in. (wide) and 60 cm/23.6 in. (tele) from your subject.
🌸	SUPER MACRO	This mode lets you shoot as close as 5 cm/2.0 in. from your subject. Zoom position is automatically set and cannot be changed.

12  **button****Self-timer shooting**



Press  in shooting mode to select on and off of the self-timer.
Press  to confirm your selection.

OFF SELFTIMER OFF Cancel the self-timer.

 SELFTIMER ON Set the self-timer.

- After setting the self-timer, press the shutter button completely. Then the self-timer lamp lights for approximately 10 seconds, blinks for approximately 2 seconds, and the shutter is released.
- To cancel the self-timer, press .
- Self-timer shooting is automatically canceled after one shot.

13  **button****Flash shooting**

Press  in shooting mode to select the flash setting.
Press  to confirm your selection.

AUTO FLASH AUTO The flash fires automatically in low light or backlight conditions.

 REDEYE This emits pre-flashes to reduce the occurrence of red-eye in your pictures.



 FILL IN The flash fires regardless of the available light.

 FLASH OFF The flash does not fire even in low light conditions.

14  **button****Erasing pictures**

In playback mode, select the picture you want to erase, and press .

- Once erased, pictures cannot be restored. Check each picture before erasing to avoid accidentally erasing pictures you want to keep.

 “ Protecting pictures” (P. 22)

Menu operations

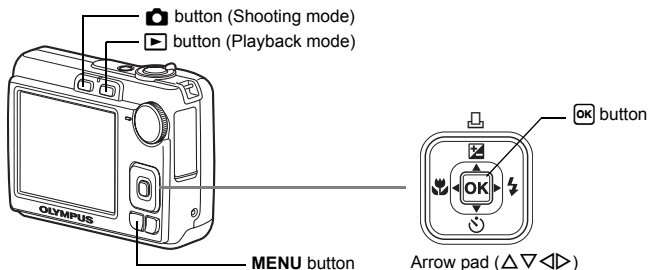

About the menus

Press **MENU** to display the Top Menu on the monitor.

- The items displayed on the Top Menu differ according to the mode.

Top Menu
(in still picture shooting mode)

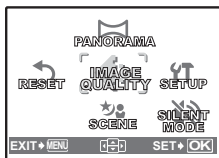

SETUP menu items

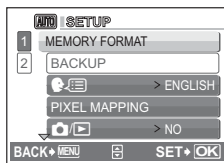

- Select [PLAYBACK MENU] or [SETUP] and press **OK** to display detailed menus from which to make settings.
- When your camera is set according to the shooting guide with the mode dial set at **GUIDE**, press **MENU** to display the shooting guide screen.

Operation guide

During menu operations, the buttons and their respective functions are displayed at the bottom of the monitor. Follow these guides to navigate the menus.

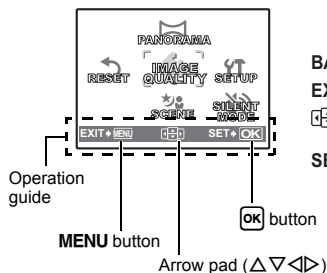

BACK+MENU : Returns to the previous menu.

EXIT+MENU : Exits the menu.

◀▶ : Press the arrow pad (Δ ∇ ◀ ▶) to select a setting.

SET+OK : Sets the selected item.

Using the menus

This explains how to use the menus with the [VIDEO OUT] setting as an example.

1 Set the mode dial to a setting other than **GUIDE**.

2 Press **MENU** to display the Top Menu.

Press **▶** to select [SETUP] and then press

OK.

- [VIDEO OUT] is one of the selections on the [SETUP].

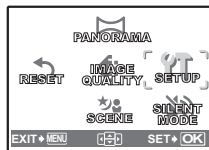

3 Use arrow pad $\Delta \nabla$ to select [VIDEO OUT], and press \square OK.

- Unavailable settings cannot be selected.
- Press \triangleleft in this screen to move the cursor to the page display. Press $\Delta \nabla$ to change the page. To select an item or function, press \triangleright or \square OK.

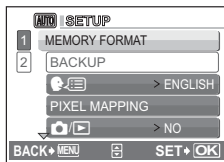

Page display: _____
The page display mark is displayed when there are additional menu items on the next page.

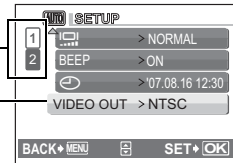

The selected item is displayed in a different color.

4 Use arrow pad $\Delta \nabla$ to select [NTSC] or [PAL] and press \square OK to confirm your selection.

- The menu item is set and the previous menu is displayed. Press **MENU** repeatedly to exit the menu.
- To cancel changes and continue menu operation, press **MENU** before pressing \square OK.

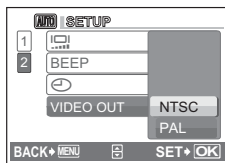

Shooting mode menu

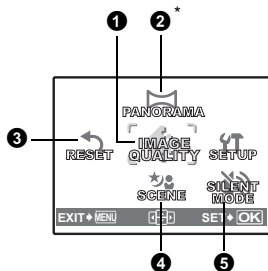

* xD-Picture Card is required.

- Some menu items are not available depending on the position of the mode dial.
 - “Functions available in shooting modes and scene modes” (P. 53)
 - “SETUP menu” (P. 25)
- The factory default settings are displayed in gray ().

Still picture image quality and their applications

Image quality/Image size	Compression	Application
SHQ 3072 × 2304	Low compression	• This is useful for printing large images on A3-size (16 × 11.7 in.) paper.
HQ 3072 × 2304	Standard compression	• This is useful for performing computer image processing, such as contrast adjustment and red-eye correction.
SQ1 2048 × 1536	Standard compression	• This is useful for printing on A4-size (11.7 × 8.5 in.) or postcard-sized (6 × 4 in.) paper. • This is useful for computer editing such as rotating or adding text to a picture.
SQ2 640 × 480	Standard compression	• This is useful for sending as e-mail attachments.
16:9 1920 × 1080	Standard compression	• This is useful for expressing the broadness of a subject such as landscapes and for viewing pictures on a wide-screen television.

Movie image quality

Image quality /Image size
SHQ 640 × 480
HQ 320 × 240

2 PANORAMA
Creating a panoramic picture

Panorama shooting lets you create a panoramic picture, software on the provided CD-ROM. An Olympus xD-Picture Card is required for panorama shooting.

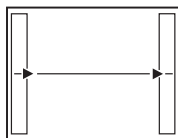

Connects pictures from left to right

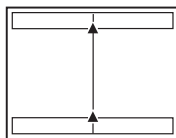

Connects pictures from bottom to top

▷: The next picture is connected at the right edge.

◁: The next picture is connected at the left edge.

△: The next picture is connected at the top.

▽: The next picture is connected at the bottom.

Use the arrow pad to specify at which edge you want to connect the pictures; and then compose your shots so that the edges of the pictures overlap. The part of the previous picture that will be combined will not remain in the frame. Remember the frame displayed on the monitor as a rough indication, then compose the shot so that the edges of the previous picture in the frame overlap with the next shot.



- Press **OK** to exit panorama shooting.
- Panorama shooting is possible for up to 10 pictures. When 10 pictures have been shot, the warning mark (🚫) will be displayed.

3 RESET

Restoring default settings

NO / YES

It restores shooting functions to their factory default settings.

Functions restored to the factory default settings

Function	Factory default setting	Ref. Page
⚡	AUTO	P. 15
🌸	OFF	P. 14
📷	0.0	P. 14
IMAGE QUALITY	HQ	P. 19
🕒	OFF	P. 15
SCENE	🏃 SPORT	P. 12

4 SCENE (Scene) Selecting a scene mode according to the shooting situation

The scene mode selection screen displays sample images as well as a description of the shooting situation for which it is designed. This can only be selected when the mode dial is set to **SCENE**.

- By switching to another scene, most settings will be changed to the default settings of each scene mode.
 - 👉 “SCENE Shoot pictures by selecting a scene mode according to the situation” (P. 12)

5 SILENT MODE

Setting to turn off operational sounds

OFF / ON

This function allows you to turn off operational sounds that occur during shooting and playback, etc...



When a still picture is selected

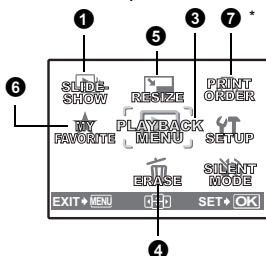

When a movie is selected

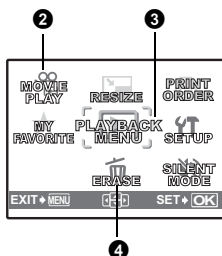

* A card is required.

“SETUP menu” (P. 25)

“SILENT MODE Setting to turn off operational sounds” (P. 20)

- The factory default settings are displayed in gray ().

1 SLIDESHOW

Playing back pictures automatically

Press **OK** to start the slideshow.

- Only the first frame of each movie is displayed.
- To stop the slideshow, press **OK** or **MENU**.

2 MOVIE PLAY

Playing back movies



Select [MOVIE PLAY] from the Top Menu, and press **OK** to play back the movie.

- In playback mode, you can also playback a movie by selecting a picture with the movie icon () and pressing **OK**.

Operations during movie playback



Playing time/Total recording time

: Fast forwards the movie while pressed.

: Rewinds the movie while pressed.

- Press **OK** to pause the playback.

Operations during pause



△: Displays the first frame.
▽: Displays the last frame.

▶: Plays the movie while pressed.
◀: Plays the movie in reverse while pressed.

- To resume the movie, press **OK**.
- To cancel the playback of the movie in the middle of it or during pause, press **MENU**.

3 PLAYBACK MENU

Protecting pictures

OFF / ON



Protected pictures cannot be erased using [ERASE], [SEL. IMAGE] or [ALL ERASE], but they are all erased by formatting.

- Select the picture with **◀▶**, and protect it by selecting [ON] with **△▽**. You can protect several frames in succession.

Rotating pictures

+90° / 0° / -90°

Pictures taken with the camera held vertically are displayed horizontally during playback. This function lets you rotate such pictures so that they are displayed vertically on the monitor, and the new picture orientations will be saved even after the power is turned off.

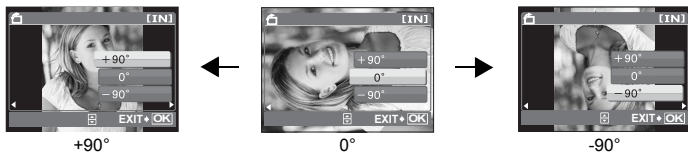

Select the picture with **◀▶** and then rotate the display by selecting [+90°]/[0°]/[-90°] with **△▽**. You can rotate several frames in succession.

4 ERASE

Erase selected pictures/Erase all pictures

Protected pictures cannot be erased. Cancel protection before erasing protected pictures. Once erased, pictures cannot be restored. Check each picture before erasing to avoid accidentally erasing pictures you want to keep.

- When erasing a picture in the internal memory, do not insert a card into the camera.
- When erasing a picture from the card, insert a card into the camera in advance.

SEL. IMAGE Erase by selecting a single-frame



- Use the arrow pad to select the picture, and press **OK** to mark ✓ on your selection.
- Press **OK** again to cancel the selection.
- When all individual pictures to be erased have been marked, press **GO+**.
- Select [YES], and press **OK**.

ALL ERASE Erase all the pictures in the internal memory and the card

- Select [YES], and press **OK**.

5 RESIZE

Reducing the size of pictures

640 × 480 / 320 × 240

This changes the image size of a picture and saves it as a new file.

6 MY FAVORITE

Viewing and registering pictures in My Favorite

The still pictures in My Favorite are registered and played back as separate pictures. Up to 9 pictures can be registered.

- Pictures registered in My Favorite cannot be erased, even by formatting.
☞ “Erasing pictures registered in My Favorite” (P. 24)

! Note

- Registered pictures cannot be edited, printed, copied to a card, transferred to the computer or played back in computer.

VIEW FAVORITES..... **Viewing the registered pictures**

- Select [VIEW FAVORITES] to display the registered pictures in My Favorite. Use the arrow pad to browse other pictures.
- [ADD FAVORITE] and [SLIDESHOW] can be selected by pressing **MENU**.

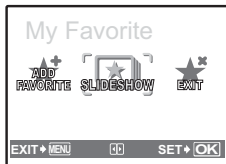

ADD FAVORITE	Register a picture in My Favorite. • Select the picture with <◁▷>, and press OK .
SLIDESHOW	Plays back registered pictures automatically. • To stop the slideshow, press OK .
EXIT	Switch to normal playback.

Erasing pictures registered in My Favorite

YES / NO

- Select the picture you want to erase with the arrow pad and press . Select [YES] and press **OK**.
- Erasing pictures registered in My Favorite will not erase pictures in internal memory or on the card.

SET **Registering a My Favorite picture**

- Select the picture with <◁▷>, and press **OK**.

7 PRINT ORDER**Making print reservations (DPOF)**

This function allows you to save printing data (the number of prints and the date and time information) with the pictures stored on the card.

- "Print settings (DPOF)" (P. 33)

SETUP menu

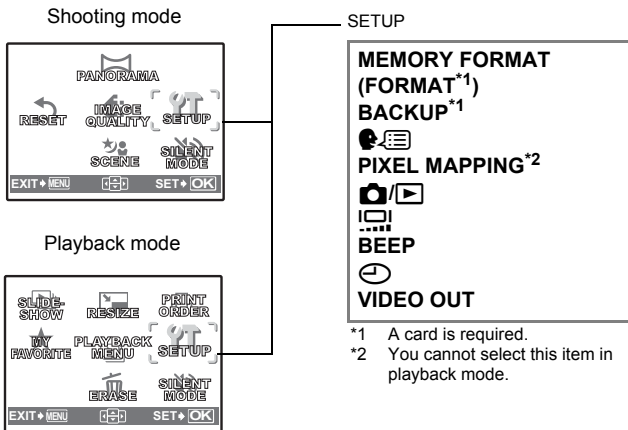

MEMORY FORMAT (FORMAT).....Formatting the internal memory or card

All existing data, including protected pictures, are erased when the internal memory or card is formatted. Make sure that you save or transfer important data to a computer before formatting.

- Make sure there is no card inserted in the camera when formatting the internal memory.
- Be sure that the card is inserted in the camera when formatting the card.
- Before using non-Olympus cards or cards which have been formatted on a computer, you must format them with this camera.

BACKUP Copying pictures in the internal memory to the card

Insert the optional card into the camera. Copying data does not erase the pictures in the internal memory.

- It takes some time to backup data. Check if the battery is not empty before starting the copy. Or use the AC adapter.

Selecting a display language

You can select a language for on-screen display. Available languages vary depending on the area where you purchased this camera.

You can add other languages to your camera with the provided OLYMPUS Master software.

PIXEL MAPPING.....Adjusting the image processing function

The pixel mapping feature allows the camera to check and adjust the CCD and image processing functions. It is not necessary to operate this function frequently.

Approximately once a year is recommended. Wait at least one minute after taking or viewing pictures to allow the pixel mapping function to perform properly. If you turn the camera off during pixel mapping, start again.

Select [PIXEL MAPPING] and when [START] is displayed, press **OK**.

/ Turning on the camera with the or button

YES/ NO

You can turn the power on by pressing either or .

..... Adjusting the brightness of monitor

BRIGHT/ NORMAL

BEEP Adjusting the volume of beep when button is pressed

OFF (No sound) / ON

..... Setting the date and time

The date and time is saved with each image, and is used in the file name. If you do not set the date and time, the screen appears every time the camera is turned on.

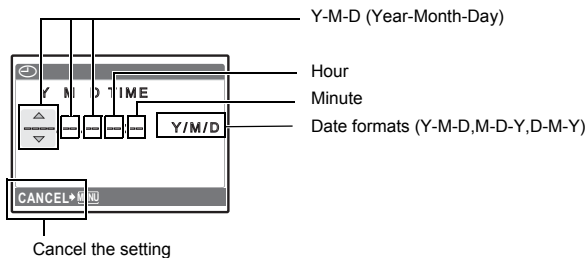

- The first two digits of the year are fixed.
- The time is displayed in the 24-hour format.
- To set the time precisely, with the cursor either "minutes" or [Y/M/D], press **OK** as the time signal strikes 00 seconds.

VIDEO OUT Playing back pictures on a TV

NTSC / PAL

The factory default settings differ according to the region where the camera is sold.

- TV video signal types by country/region. Check the video signal type before connecting the camera to the TV.

NTSC: North America, Taiwan, Korea, Japan

PAL: European countries, China

Playing back pictures on a TV

Turn off the camera and the TV before connecting.

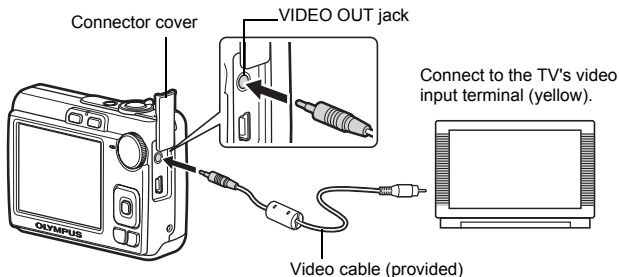

Settings on the camera

Turn on the camera and then press  to enter playback mode.

- The last picture taken is displayed on the TV. Use the arrow pad to select the picture you want to display.

Settings on the TV

Turn the TV on, and set it to video input mode.

- For details of switching to video input, refer to your TV's instruction manual.
- Images and the information displayed on the screen may be cropped depending on the TV's settings.

Direct printing (PictBridge)

By connecting the camera to a PictBridge-compatible printer, you can print pictures directly - no computer necessary. Select the pictures you want to print and the number of prints using the camera's print menus.

To find out if your printer is compatible with PictBridge, refer to the printer's instruction manual.

What is PictBridge?

A standard for connecting digital cameras and printers of different makers and printing out pictures directly.

- Available printing modes, paper sizes etc..., vary depending on the printer you use. Refer to the instruction manual for your printer.
- For details of printing paper types, ink cassettes, etc..., refer to the printer's instruction manual.

EASY PRINT

[EASY PRINT] can be used to print out the picture displayed on the monitor. The selected picture is printed using the standard settings of your printer. The date and file name are not printed.

STANDARD

All printers that support PictBridge have standard print settings. If [STANDARD] is selected on the settings screens (P. 31), pictures are printed according to these settings. Refer to the printer's instruction manual for its standard settings or contact the printer manufacturer.

- 1 Display the picture you want to print out on the monitor in playback mode.**

- 2** Turn the printer on and plug the **USB cable (provided)** into the camera's **USB connector** and the printer's **USB port**.

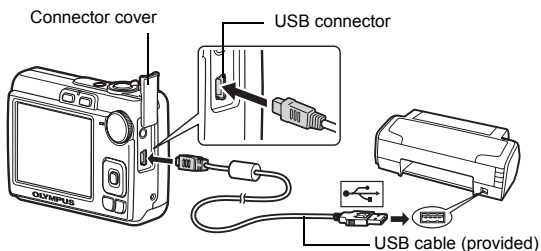

- The [EASY PRINT START] screen is displayed.
- For details of how to turn the printer on and the position of the USB port, refer to the printer's instruction manual.

- 3** Press **△** **☒** / **☐**.

- Printing starts.

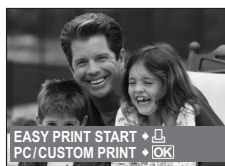

- When printing is finished, the picture selection screen is displayed. To print another picture, press **◀▶** to select a picture, and press **△** **☒** / **☐**.
- When you are finished, disconnect the USB cable from the camera with the picture selection screen displayed.



- 4** Disconnect the **USB cable** from the camera.

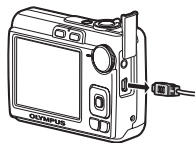

- 5** Disconnect the USB cable from the printer.

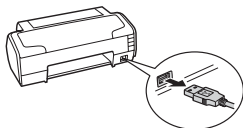

You can use [EASY PRINT] even when the camera is turned off or in shooting mode. With the camera turned off or in shooting mode, connect the USB cable. The selection screen for the USB connection is displayed. Select [EASY PRINT].

-  “EASY PRINT” step 3 (P. 29), “Other print modes and print settings (CUSTOM PRINT)” step 2 (P. 30)

Other print modes and print settings (CUSTOM PRINT)

- 1** Display the screen indicated on the right according to procedure 1 and 2 on P. 28-P. 29, and press .



USB screen

- 2** Select [CUSTOM PRINT], and press .

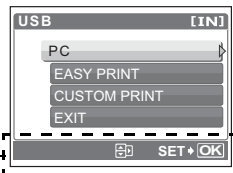

Operation guide

- 3** Follow the operation guide to adjust print settings.

Selecting a print mode

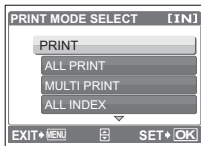

PRINT	Prints the selected picture.
ALL PRINT	Prints all the pictures stored in the internal memory or on the card.
MULTI PRINT	Prints one picture in multiple layout format on a single sheet of paper.
ALL INDEX	Prints an index of all the pictures stored in the internal memory or on the card.
PRINT ORDER	Prints the pictures according to the print reservation data on the card. If no print reservations have been made, this option is not available. 🔍 "Print settings (DPOF)" (P. 33)

Setting the print paper

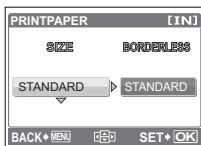

SIZE	Choose from the available paper sizes on your printer.
BORDERLESS	Select with or without borders. In [MULTI PRINT] mode, you cannot print with a border.
OFF (☐)	The picture is printed inside a blank frame.
ON (☐)	The picture is printed filling the entire page.
PICS/SHEET	Available in [MULTI PRINT] mode only. The number of prints that can be printed vary depending on the printer.

! Note

- If the [PRINTPAPER] screen is not displayed, [SIZE], [BORDERLESS] and [PICS/SHEET] are set to as [STANDARD].

Selecting the picture to print



PRINT	Prints one copy of the selected picture. When [SINGLE PRINT] or [MORE] has been selected, a single copy or more copies are printed.
SINGLE PRINT	Makes a print reservation for the displayed picture.
MORE	Sets the number of prints and data to be printed for the displayed picture.

Press \triangleleft \triangleright to select the picture you want to print. You can also use the zoom lever and select a picture from the index display.

Setting the number of prints and data to be printed

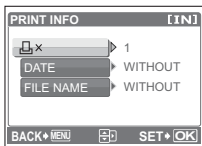

x	Sets the number of prints. You can select up to 10 prints.
DATE (☺)	If you select [WITH], pictures are printed with the date.
FILE NAME (☺)	If you select [WITH], pictures are printed with the file name.

4 Select [PRINT], and press OK .

- Printing starts.
- When printing is finished, the [PRINT MODE SELECT] screen is displayed.

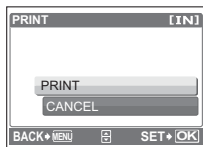

To cancel printing

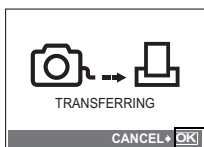

Screen during data transfer

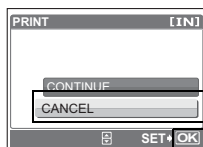

Select [CANCEL], and press OK

5 In the [PRINT MODE SELECT] screen, press MENU.

- A message is displayed.

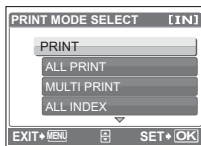

6 Disconnect the USB cable from the camera.

- The camera turns off.

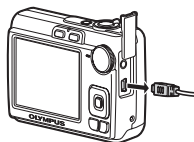

7 Disconnect the USB cable from the printer.

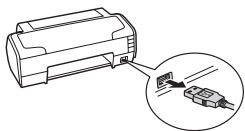

Print settings (DPOF)

How to make print reservations

Print reservations allows you to save printing data (the number of prints and the date and time information) with the pictures stored on the card.

With print reservation, you can print out pictures easily either at home using a personal DPOF-compatible printer or at a photo store that supports DPOF. DPOF is a standard format used to record automatic print information from digital cameras.

Only the images stored on the card can be reserved to print. Insert a card with recorded pictures into the camera before making print reservations.

Pictures with print reservations can be printed using the following procedures.

Printing using a DPOF-compatible photo store.

The pictures are printed according to the reserved information.

Printing using a DPOF-compatible printer.

Printing is possible directly from a card containing print reservation data, without using a computer. For more details, refer to the printer's instruction manual. A PC card adapter may also be necessary.

! Note

- DPOF reservations set by another device cannot be changed by this camera. Make changes using the original device. If a card contains DPOF reservations set by another device, entering reservations using this camera may overwrite the previous reservations.
- You can make DPOF print reservations for up to 999 images per card.
- Not all functions may be available on all printers or at all photo stores.

To use print services without using DPOF

- Pictures stored in the internal memory cannot be printed at a photo store. The pictures need to be copied to a card before taking them to the photo store.
☞ “BACKUP Copying pictures in the internal memory to the card” (P. 25)

Single-frame reservation

Follow the operation guide to make a print reservation for a selected picture.

1 Press **MENU** in the playback mode to display the Top Menu.

2 Select **[PRINT ORDER]** ▶ and then **[↓]**, and press **[OK]**.

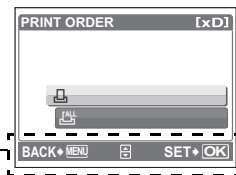

Operation guide

3 Press **◀▶** to select the frames for print reservations, and then press **△▽** to set the number of prints.

- You cannot make print reservations for pictures with .
- Repeat step 3 to make print reservations for other pictures.



4 When you finish making print reservations, press **[OK]**.

5 Select the date and time print setting, and press **[OK]**.

- NO** The pictures are printed without the date and time.
- DATE** The selected pictures are printed with the shooting date.
- TIME** The selected pictures are printed with the shooting time.

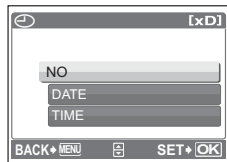

- 6 Select [SET], and press **OK**.

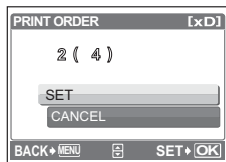

All-frame reservation

Reserves all the pictures stored on the card. The number of prints is set at one print per picture.

- 1 Press MENU in the playback mode to display the Top Menu.
- 2 Select [PRINT ORDER] ► and then [**FALL**], and press **OK**.
- 3 Select the date and time setting, and press **OK**.
 - NO The pictures are printed without the date and time.
 - DATE All pictures are printed with the shooting date.
 - TIME All pictures are printed with the shooting time.
- 4 Select [SET], and press **OK**.

Resetting print reservation data

You can reset all the print reservation data or just for selected pictures.

- 1 Select Top Menu ► and then [PRINT ORDER], and press **OK**.

To reset the print reservation data for all the pictures:

- 2 Select [**ALL**] or [**FALL**] and press **OK**.
- 3 Select [RESET], and press **OK**.

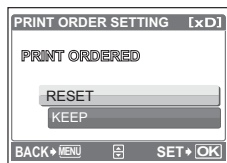

To reset the print reservation data for a selected picture:

- 2** Select [**⏏**] and press **[OK]**.
- 3** Select [**KEEP**], and press **[OK]**.
- 4** Press **◀▶** to select the picture with the print reservations you want to cancel, and press **▽** to decrease the number of prints to 0.
 - Repeat step 4 to cancel print reservations for other pictures.
- 5** When you are finished canceling print reservations, press **[OK]**.
- 6** Select the date and time setting, and press **[OK]**.
 - The setting is applied to the remaining pictures with print reservations.
- 7** Select [**SET**], and press **[OK]**.

Using OLYMPUS Master

Overview

Using the USB cable provided with your camera, you can connect the camera and computer and download (transfer) the images to your computer using the OLYMPUS Master software, also provided with the camera.

Prepare the following items before starting.



OLYMPUS Master 2
CD-ROM



USB cable



Computer equipped with a USB port

Install the OLYMPUS Master software P. 38



Connect the camera to the computer using the USB cable P. 40



Start up the OLYMPUS Master software P. 41



Download image files to the computer P. 41



Disconnect the camera from the computer P. 42

Using OLYMPUS Master

What is OLYMPUS Master?

OLYMPUS Master is a software application for managing your digital images on your computer. Installing it on your computer lets you do the following:

- **Download images from the camera or other media**
- **View images and movies**
 - You can run a slideshow and play back movies.
- **Manage images**
 - Manage images in an album or folder.
 - Downloaded images are automatically sorted by date, allowing you to search for images quickly.
- **Edit images**
 - You can rotate images, trim them and change the size.
- **Edit images with the filter and correction functions**

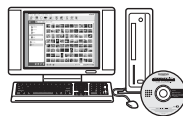

- **Print images**
 - You can easily print images.
- **Make panoramic images**
 - You can make panoramic images using pictures taken in panorama mode.
- **Update the version of your camera's firmware**

For details of other functions and operations, refer to the "Help" guide in the OLYMPUS Master reference manual.

Install the OLYMPUS Master software

Before installing the OLYMPUS Master software, please confirm that your computer is compatible with the following system requirements.

For newer operating systems, please refer to the Olympus web site as shown on the back cover of this manual.

Operating environment

Windows

OS	Windows 2000 Professional/XP Home Edition/XP Professional/Vista
CPU	Pentium III 500 MHz or later
RAM	256 MB or more
Hard disk capacity	500 MB or more
Monitor	1,024 × 768 pixels or more 65,536 colors or more (16.77 million colors or more recommended)
Other	USB port or IEEE 1394 port Internet Explorer 6 or later QuickTime 7 or later recommended DirectX 9 or later recommended



Note

- **Windows 98/98SE/Me are not supported.**
- Use a computer with a pre-installed operating system. Operations are not guaranteed on home-built computers or computers with an updated operating system.
- Operations are not guaranteed when using an added USB port or IEEE 1394 port.
- To install the software, you must log on as a user with administrators' privileges.

Macintosh

OS	Mac OS X v10.3 or later
CPU	Power PC G3 500 MHz or later Intel Core Solo/Duo 1.5 GHz or later
RAM	256 MB or more
Hard disk capacity	500 MB or more
Monitor	1,024 × 768 pixels or more 32,000 colors or more (16.77 million colors or more recommended)
Other	USB port or IEEE 1394 port (FireWire) Safari 1.0 or later (1.3 or later recommended) QuickTime 6 or later



Note

- **Mac versions earlier than OS X 10.3 are not supported.**
- Operations are not guaranteed when using an added USB or IEEE 1394 (FireWire) port.
- To install the software, you must log on as a user with administrators' privileges.
- Be sure to remove the media (drag & drop onto the trash icon) before performing the following operations. Failure to do so could result in unstable computer operation and the need to reboot.
 - Disconnect the cable connecting the camera to the computer
 - Turn off the camera
 - Open the camera's battery/card compartment cover

Windows

- 1 Insert the CD-ROM into the CD-ROM drive.**
 - The OLYMPUS Master setup screen is displayed.
 - If the screen is not displayed, double-click the "My Computer" icon and click the CD-ROM icon.
 - 2 Select the display language and click the "OLYMPUS Master 2" button.**
 - When the component installation screen is displayed, click "OK".
 - 3 Click "Next" and follow the on-screen instructions.**
 - When the OLYMPUS Master licensing agreement is displayed, read the agreement and click "Yes" to proceed with the installation.
 - 4 When the user information screen is displayed, enter your "Name", select your "Region" and click "Next".**
 - 5 When the setup type selection screen is displayed, click "Install".**
 - To select the components to install, select "Custom".
- The installation begins. The screen confirming that setup is completed is displayed. Click "Close".
- Next, the screen confirming whether to install OLYMPUS muvee theaterPack Trial Version is displayed. To install this software, click "Install".

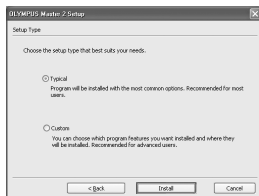
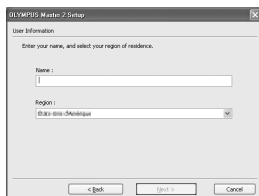
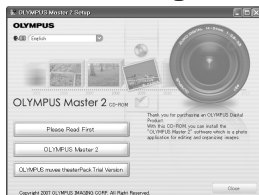

Macintosh**1 Insert the CD-ROM into the CD-ROM drive.**

- The CD-ROM window is displayed.
- If the CD-ROM window is not displayed, double-click the CD-ROM icon on the desktop.

**2 Double-click the "Setup" icon on the desktop.**

- The OLYMPUS Master installation screen is displayed.
- Follow the on-screen instructions.
- When the OLYMPUS Master licensing agreement is displayed, read the agreement and click "Continue" and then "Continue" to proceed with the installation.
- The screen confirming that installation is completed is displayed.
- You must restart your computer before using OLYMPUS Master.

**Connecting the camera to a computer****1 Make sure the camera is turned off.**

- The monitor is off.
- The lens is retracted.



Monitor

2 Connect the USB connector on the camera to the USB port on the computer using the provided USB cable.

- Refer to your computer's instruction manual to locate the position of the USB port.
- The camera turns on automatically.
- The monitor turns on and the selection screen for the USB connection is displayed.

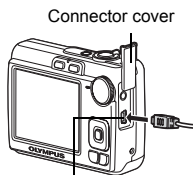

Connector cover

USB connector

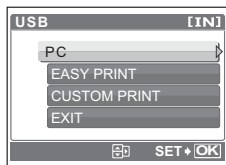
3 Select [PC], and press .

4 The camera is recognized by the computer.

• Windows

When you connect the camera to your computer for the first time, the computer attempts to recognize the camera. Click "OK" to exit the message that is displayed. The camera is recognized as a "Removable Disk".

• Macintosh

The iPhoto program is the default application for managing digital images. When you connect your digital camera for the first time, the iPhoto application starts automatically, so close this application and start OLYMPUS Master.

! Note

- The camera functions are disabled while the camera is connected to a computer.
- Connecting the camera to a computer via a USB hub may cause unstable operation. In this case, do not use a hub, but connect the camera directly to the computer.
- Images cannot be transferred to your computer with OLYMPUS Master if [PC] is selected in Step 3, ▷ is pressed and [MTP] is selected.

Start up the OLYMPUS Master software

Windows

1 Double-click the "OLYMPUS Master 2" icon  on the desktop.

Macintosh

1 Double-click the "OLYMPUS Master 2" icon  in the "OLYMPUS Master 2" folder.

- The browse window is displayed.
- When OLYMPUS Master is started up for the first time after installation, the OLYMPUS Master initial setting screen and user registration screen are displayed before the browse window. Follow the on-screen instructions.

To exit OLYMPUS Master

1 Click "Exit"  on any window.

- OLYMPUS Master is exited.

Displaying camera images on a computer

Downloading and saving images

1 Click "Transfer Images"  on the browse window, and then click "From Camera" .

- The window for selecting the pictures you want to transfer from the camera is displayed. All the images in the camera are displayed.

2 Select "New Album" and enter an album name.

3 Select the image files and click "Transfer Images".

- A window indicating that the download is complete is displayed.



4 Click "Browse images now".

- The downloaded images are displayed in the browse window.



To disconnect the camera

1 Make sure that the card access lamp has stopped blinking.

Card access lamp

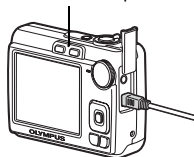

2 Make the following preparations for disconnecting the USB cable.

Windows

- Click the "Unplug or Eject Hardware" icon  in the system tray.
- Click the message that is displayed.
- When a message is displayed saying that the hardware can be ejected safely, click "OK".

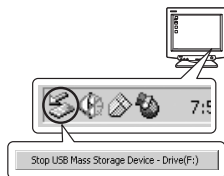

Macintosh

- The trash icon changes to the eject icon when the "Untitled" or "NO_NAME" icon on the desktop is dragged. Drag and drop it on the eject icon.



3 Disconnect the USB cable from the camera.

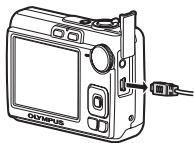

Note

- Windows: When you click "Unplug or Eject Hardware", a warning message may be displayed. Make sure that image data is not being downloaded from the camera and that all applications are closed. Click the "Unplug or Eject Hardware" icon again and disconnect the cable.

Viewing still pictures and movies

- 1 Click the “Album” tab on the browse window and select the album that you want to view.
 - The selected album image is displayed in the thumbnail area.
- 2 Double-click the still picture thumbnail that you want to view.
 - OLYMPUS Master switches to the image edit window and the picture is enlarged.
 - Click “Back”  to return to the browse window.



To view a movie

- 1 Double-click the movie thumbnail that you want to see in the browse window.
 - OLYMPUS Master switches to the edit window and the first frame of the movie is displayed.
- 2 To play back the movie, click “Play”  at the bottom of the screen.



To download and save images to a computer without using OLYMPUS Master

This camera is compatible with USB mass storage. You can connect the camera to your computer using the USB cable provided with the camera to download and save images without using OLYMPUS Master. The following environment is required to use the USB cable to connect the camera to your computer.

Windows: Windows 98SE/Me/2000 Professional/XP Home Edition/XP Professional/Vista

Macintosh: Mac OS 9.0 to 9.2/X

Note

- If your computer is running Windows 98SE, you will need to install the USB driver. Before connecting the camera to your computer with the USB cable, double-click the files from the following folders on the provided OLYMPUS Master CD-ROM.
(Drive name): \win98usb\INSTALL.EXE
- If your computer is running Windows Vista, you can select [PC] in Step 3 on P. 40, press **▷**, and select [MTP] to use Windows Photo Gallery.
- Data transfer is not guaranteed in the following environments, even if your computer is equipped with a USB port.
 - Windows 95/98/NT 4.0
 - Windows 98SE upgrades from Windows 95/98
 - Mac OS 8.6 or earlier
 - Computers with a USB port added by means of an extension card, etc.
 - Computers without a factory-installed OS and home-built computers

To increase the number of languages

Please take care that your battery is fully charged!

- 1 Make sure that your computer is connected to the Internet.**
- 2 Plug the USB cable into the USB port on the computer.**
- 3 Plug the other end of the USB cable into the camera's USB connector.**
 - The camera turns on automatically.
 - The monitor turns on and the selection screen for the USB connection is displayed.
- 4 Select [PC], and press **OK**.**
- 5 In the browse window, select "Camera", then "Update Camera/Add Display Language".**
 - The confirmation window for updating is displayed.
- 6 Click "OK".**
 - The updating the camera window is displayed.
- 7 Click "Add Language" in the updating camera display.**
 - The "Add Display Language of Camera" window is displayed.
- 8 Click **▼** and select a language.**
- 9 Click "Add".**
 - The new language is downloaded to your camera.
Please do not remove any cable or the battery while the camera is processing.
- 10 After the download procedure the camera display will show "OK". You can remove the cables and turn power off. After restarting the camera you will be able to choose the new language from [SETUP].**

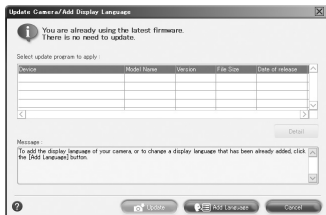

Shooting tips and information

Tips before you start taking pictures

The camera does not turn on even when a battery is loaded

The battery is inserted incorrectly

- Remove the batteries and insert them correctly.

There is not enough power left in the battery

- Insert new batteries. Or, charge it when using the rechargeable battery.

The battery is temporarily unable to function because of the cold

- Battery performance declines in low temperatures, and the charge may not be sufficient to turn on the camera. Remove the battery and warm it by putting it in your pocket for a while.

No picture is taken when the shutter button is pressed

The camera is in sleep mode

- To save battery power, the camera automatically goes into sleep mode and the monitor turns off if there is no operation when the camera is turned on (when the lens is extended and the monitor is on). No picture is taken even if the shutter button is fully pressed in this mode. Operate the zoom lever or other buttons to restore the camera from sleep mode before taking a picture. If the camera is left for 12 minutes, it automatically turns off (the lens retracts and the monitor turns off). When the power is turned on in the playback mode, the camera does not enter the sleep mode but just turns off automatically after about three minutes. Press **POWER** to turn the camera on.

The mode dial is in the position of **GUIDE**

- No pictures can be taken when the guide is being displayed. Take pictures after setting target terms by following the shooting guide or set it to the setting other than **GUIDE** in shooting mode.

The flash is charging

- Wait until the  (flash charge) mark stops blinking before pushing the shutter button again.

The date and time have not been set

The camera has been used in the same conditions from the time of purchase

- No date and time have been set in the camera at the time of purchase. Set the date and time before using the camera.

 "Set date and time" (P. 6),  "Setting the date and time" (P. 26)

The battery has been pulled out of the camera

- The date and time settings will be returned to the factory default settings if the camera is left without batteries for approximately 1 day. The settings will be canceled more quickly if the batteries were only loaded in the camera for a short time before being removed. Before taking important pictures, check that the date and time settings are correct.

Shooting tips

Focusing on the subject

There are several ways to focus, depending on the subject.

When the subject is not in the center of the frame

- Place the subject in the center of the frame, lock the focus on the subject, and then recompose your picture.

 “Shutter button Shooting pictures” (P. 10)

The subject is moving quickly

- Focus the camera on a point roughly the same distance away as the subject you want to shoot and lock the focus (by pressing the shutter button halfway). Then recompose your picture and press the shutter button completely as the subject enters the frame.
- Select  from **SCENE** to shoot pictures.

 “**SCENE** Shoot pictures by selecting a scene mode according to the situation” (P. 12)

Subjects that are difficult to focus on

- Under certain types of conditions, it is difficult to focus using auto focus. The green lamp on the monitor lights, allowing you to check if the focus is locked.

The green lamp blinks.
The subject cannot be brought into focus.



Subject with low contrast



Subject with an extremely bright area in the center of the frame

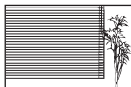

Subject without vertical lines

The green lamp lights, but the subject cannot be brought into focus.



Subjects at different distances

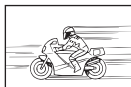

Fast-moving subject





The subject is not in the center of the frame

In these cases, focus (focus lock) on an object with high contrast at the same distance as the intended subject, recompose your shot and then take the picture. If the subject has no vertical lines, hold the camera vertically and focus the camera using the focus lock function by pressing the shutter button halfway, and then return the camera to the horizontal position while keeping the button pressed halfway and take the picture.

Prevent blur by using image stabilization

Be sure to hold the camera firmly with both hands and press the shutter button slowly so as to avoid moving the camera. You can reduce the blurring by shooting the picture in  mode.

 “ Shooting pictures with digital image stabilization” (P. 11)

The factors that can cause the picture to blur are as follows:

- images are shot at a high-magnification zoom setting, i.e. using both optical zoom and digital zoom functions.
- the object is dark and the shutter speed is slow, or
- scene modes where the flash is turned off and/or the shutter speed is slow.

Taking pictures without the flash

The flash is activated automatically when there is insufficient light and the camera is shaken. To take pictures without using the flash even when it is dark, set the flash mode to [🚫] (FLASH OFF).

The picture is too grainy

There are several factors that can cause the picture to appear grainy.



Using the digital zoom to take close-up pictures

- With the digital zoom, part of the image is cropped and enlarged. The greater the magnification, the grainier the picture appears.

Shooting pictures with the mode dial set to , or the SCENE mode set to

- When shooting pictures in the above modes, the picture may appear grainy if the subject is dark.





   Shooting pictures according to the situation" (P. 11)

"SCENE Shoot pictures by selecting a scene mode according to the situation" (P. 12)

Taking pictures of a white beach or snow scene

- Often, bright subjects (such as snow) turn out darker than their natural colors. Adjust [☒] (exposure compensation) toward [+] to make these subjects closer to their true shades. Conversely, when you are shooting dark subjects, it can be effective to adjust toward the [-]. Sometimes, using the flash may not produce the brightness (exposure) that was intended.





  button Changing picture brightness/Printing pictures" (P. 14)

Taking pictures of a subject against backlight

- Set the flash to [🔆] (FILL IN) to activate fill-in-flash. You can shoot a subject against backlight without the face of the subject appearing dark. [🔆] (FILL IN) is effective for shooting against backlight and under fluorescent and other artificial lighting.



  button Flash shooting" (P. 15)

Increasing the number of pictures that can be taken

There are two ways to record the pictures you take with this camera.

Recording pictures to the internal memory

- Pictures are recorded to the internal memory, and when the number of storable still pictures reaches 0, you must connect the camera to a computer to download the pictures, and then erase the pictures from the internal memory.

Using an xD-Picture Card (optional)

- Pictures are recorded to the card when inserted in the camera. When the card is full, you download the pictures to a computer, and then either erase the pictures from the card or use a new card.
- Pictures are not recorded to the internal memory when a card is inserted in the camera. Pictures in the internal memory can be copied to the card using the [BACKUP] function.

 "BACKUP Copying pictures in the internal memory to the card" (P. 25)
"The card" (P. 55)

Number of storable still pictures and recording length of movies

Still pictures

IMAGE QUALITY	Image size	Number of storable still pictures	
		Internal memory	Card (512 MB)
SHQ	3072 × 2304	1	86
HQ	3072 × 2304	3	255
SQ1	2048 × 1536	7	570
SQ2	640 × 480	39	2904
16:9	1920 × 1080	8	652

Movie

IMAGE QUALITY	Image size	Remaining recording time	
		Internal memory	Card (512 MB)
SHQ	640 × 480 (15 frames/sec.)	7 sec.	9 min. 5 sec.
HQ	320 × 240 (15 frames/sec.)	20 sec.	25 min. 26 sec.

Using a new card

- If you use a non-Olympus card or a card used for another application, such as for a computer, the message [CARD ERROR] is displayed. To use this card with this camera, use the [FORMAT] function to format the card.

 "MEMORY FORMAT (FORMAT) Formatting the internal memory or card" (P. 25)

Lamp indicators

This camera uses several lamps to indicate the camera status.

Lamp	Status
Self-timer lamp	The lamp lights for approximately 10 seconds, blinks for approximately 2 seconds, and then the picture is taken.
Card access lamp	Lit (red): Shooting mode and power is on. Lit (green): Playback mode and power is on. Off: Power is off. Blinking (red): An image or movie is being recorder or downloaded (when connected to a computer). <ul style="list-style-type: none">• Do not do any of the following while the card access lamp is blinking. Doing so may prevent the image data from being saved and render the internal memory or card unusable.<ul style="list-style-type: none">• Open the battery/card compartment cover• Remove the battery• Connect or disconnect the AC adapter
Green lamp of the monitor	Lit: The focus and exposure are locked. Blinking: The focus is not locked. <ul style="list-style-type: none">• Release your finger from the shutter button, re-position the AF target mark on the subject and press the shutter button halfway again.

Extending the useful life of the battery

- Performing any of the following operations when not actually taking pictures can deplete the battery power.
 - Repeatedly pressing the shutter button halfway
 - Repeatedly using the zoom
- To save battery power, turn off the camera whenever it is not in use.

Functions that cannot be selected from menus

- Some items may not be selectable from the menus when using the arrow pad.
 - Items that cannot be set with the current shooting mode
 - Items that cannot be set because of an item that has already been set: [S/M], [L], etc.
- Some functions cannot be used when there is no card in the camera.
[PANORAMA]/[FORMAT]/[BACKUP]/[PRINT ORDER]

Selecting the appropriate image quality

Image quality is a combination of desired image size and compression level. Use the following examples to help determine the optimal record mode when shooting.

To make high quality prints on full-size paper such as A3 (16.5×11.7 in.)/To edit and process images on a computer

- [SHQ] or [HQ]

To print on A4 (11.7×8.5 in.) or postcard-size (6×4 in.) size paper

- [SQ1]

To send as an e-mail attachment or post on a Web site

- [SQ2]

To express the broadness of a subject such as landscapes/To view pictures on a wide-screen television

- [16:9]

 "IMAGE QUALITY Changing the image quality" (P. 19)

Restoring default settings

- To return the changed shooting settings to default settings while shooting, set [RESET] to [YES].
- ☞ “RESET Restoring default settings” (P. 20)
- When the camera is turned off, all the shooting settings other than [IMAGE QUALITY] and the scene mode return to default.

Playback tips

Playing back the pictures in the internal memory

A card is inserted in the camera

- When a card has been inserted in the camera, the pictures in the internal memory cannot be played back. Turn off the camera and remove the card to playback pictures stored in the camera's internal memory.

Quickly displaying a desired picture

- Turn the zoom lever to the **W** side to view the pictures as thumbnails (index display).
- ☞ “Zoom lever Zooming while shooting/close-up playback” (P. 13)

Viewing pictures on a computer

Viewing the entire picture on a computer screen

The size of the picture displayed on a computer screen changes depending on the computer settings. When the monitor setting is 1,024 × 768 and you are using Internet Explorer to view a picture with an image size of 2,048 × 1,536 at 100%, the entire picture cannot be viewed without scrolling. There are several ways you can view the entire picture on the computer screen.









View the picture using image browsing software







- Install the OLYMPUS Master software from the provided CD-ROM.

Change the monitor setting

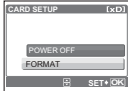
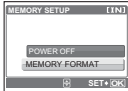
- The icons on the computer desktop may be rearranged. For details on changing the settings on your computer, refer to the computer's instruction manual.

When you get an error message on the camera...

Monitor indication	Possible cause	Corrective action
 CARD ERROR	There is a problem with the card.	This card cannot be used. Insert a new card.
 WRITE-PROTECT	Writing to the card is prohibited.	The recorded image has been protected (read-only) on a computer. Download the image to a computer and cancel the read-only setting.
 MEMORY FULL	The internal memory has no available memory and cannot store any new data.	Insert a card or erase unwanted data. Before erasing, backup the data of important pictures using the card, or download such pictures to a computer.
 CARD FULL	The card has no available memory and cannot store any new data.	Replace the card or erase unwanted data. Before erasing, download important pictures to a computer.
 NO PICTURE	There are no pictures in the internal memory or on the card.	The internal memory or the card contains no pictures. Record pictures.
 PICTURE ERROR	There is a problem with the selected picture and it cannot be played back on this camera.	Use image processing software to view the picture on a computer. If that cannot be done, the image file is damaged.
 CARD-COVER OPEN	The battery/card compartment cover is open.	Close the battery/card compartment cover.
 BATTERY EMPTY	The battery is empty.	Insert a new battery. Or, charge it when using the rechargeable battery.

Monitor indication	Possible cause	Corrective action
	This card cannot be used in this camera. Or, the card is not formatted.	Format the card or replace. <ul style="list-style-type: none"> • Select [POWER OFF] and press OK and then insert a new card. • Select [FORMAT] ► [YES] and press OK. The card is formatted. All data on the card is erased during formatting.
	There is an error in the internal memory.	Select [MEMORY FORMAT] ► [YES] and press OK . The internal memory is formatted. All data in the internal memory is erased.
 NO CONNECTION	The camera is not connected to the computer or the printer correctly.	Connect the camera and the computer or the printer correctly.
 NO PAPER	There is no paper in the printer.	Load some paper in the printer.
 NO INK	The printer has run out of ink.	Replace the ink cartridge in the printer.
 JAMMED	The paper is jammed.	Remove the jammed paper.
SETTINGS CHANGED	The printer's paper tray has been removed or the printer has been operated while changing settings on the camera.	Do not operate the printer while changing settings on the camera.
 PRINT ERROR	There is a problem with the printer and/or camera.	Turn off the camera and printer. Check the printer and remedy any problems before turning the power on again.
 CANNOT PRINT	Pictures recorded on other cameras may not be printed on this camera.	Use a computer to print the pictures.

Functions available in shooting modes and scene modes

Some functions cannot be set in certain shooting modes. For more details, refer to the table below.

Functions available in shooting modes

Function	Shooting mode						SCENE				
	AUTO										
		✓		—			✓			—	
		✓		—			✓			—	
						✓					
			✓			—	✓	—	✓		—
						✓					
ZOOM				✓				—			✓
IMAGE QUALITY						✓					—*
PANORAMA			✓			—		✓			—
MEMORY FORMAT (FORMAT)						✓					
BACKUP						✓					
						✓					
PIXEL MAPPING						✓					
						✓					
						✓					
BEEP						✓					
						✓					
VIDEO OUT						✓					

* The picture quality is fixed to [640 × 480].

Camera care

Cleaning the camera

Exterior:

- Wipe gently with a soft cloth. If the camera is very dirty, soak the cloth in mild soapy water and wring well. Wipe the camera with the damp cloth and then dry it with a dry cloth. If you have used the camera at the beach, use a cloth soaked in clean water and wrung well.

Monitor:

- Wipe gently with a soft cloth.

Lens:

- Blow dust off the lens with a commercial blower, then wipe gently with a lens cleaner.



Note

- Do not use strong solvents such as benzene or alcohol, or chemically treated cloth.
- Mold may form on the lens surface if the lens is left dirty.

Storage

- When storing the camera for extended periods, remove the battery, AC adapter and card, and keep in a cool, dry place that is well ventilated.
- Periodically, insert the battery and test the camera functions.



Note

- Avoid leaving the camera in places where chemical products are handled since this may result in corrosion.

The battery

- In addition to the batteries provided with the camera, the following types of battery can be used. Choose the power source best suited to the situation.

AA alkaline batteries/Oxyride batteries

The number of pictures that you can take may vary considerably depending on the battery manufacturer and shooting conditions.

AA NiMH batteries (rechargeable batteries)

Olympus NiMH batteries are rechargeable and economical. For details, refer to the instruction manual for your charger.

- **Lithium battery packs (CR-V3) and AA manganese (zinc-carbon) batteries cannot be used.**
- Power consumption by the camera varies depending on which functions are used.
- Power is consumed continuously during the conditions described below causing batteries to become exhausted quickly.
 - The zoom is used repeatedly.
 - The shutter button is pressed halfway repeatedly in shooting mode, activating the auto focus.
 - The monitor is left on for an extended period of time.
 - The camera is connected to a computer or printer.

- The battery life varies widely depending on the type of battery, manufacturer, shooting conditions, etc. Because of this, there may be cases where the camera turns itself off without displaying the battery level warning, or displays the battery level warning sooner than usual.

Useful use of the accessories

The card

Pictures can be recorded on the optional card.

The internal memory and card are the camera's media for recording pictures, similar to film in a film camera.

Pictures recorded to the internal memory or card can be easily erased on the camera or processed using a computer.

Unlike portable storage media, the internal memory cannot be removed or exchanged. The number of recordable pictures can be increased by using a card with a larger capacity.

① Index area

You can use this space to write the contents of the card.

② Contact area

The part where the data transferred from the camera enters the card.

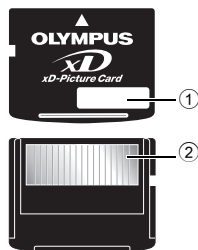

Compatible cards

xD-Picture Card (16 MB – 2 GB) (Type H/M, Standard)

Using the internal memory or card

You can confirm on the monitor whether the internal memory or card is being used during shooting and playback operations.

Shooting mode



Playback mode



Memory indicator
 [IN]: Internal memory
 [xD]: Card

Inserting and removing the card

- 1 Turn off the camera.
- 2 Open the battery/card compartment cover.

Battery/card compartment cover

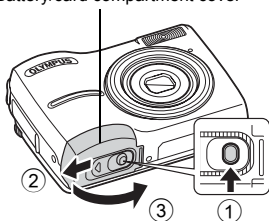

Inserting the card

- 3 Orient the card as shown, and insert it into the card slot as shown in the illustration.

- Insert the card straight in.
- Insert the card until it clicks into place.

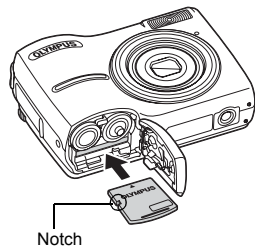

Removing the card

- 4 Push the card all the way in and release slowly.

- The card protrudes slightly and stops.

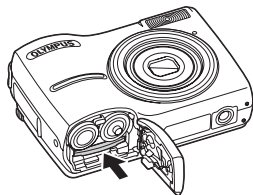

- Grasp the card and remove it.

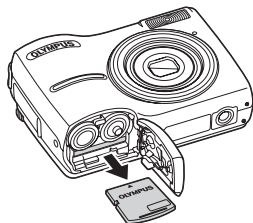

5 Close the battery/card compartment cover.

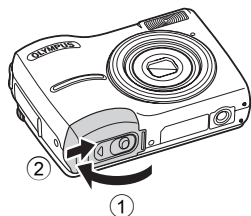

Note

- The card access lamp blinks while the camera is reading or writing the images. Do not open the battery/card compartment cover while the card access lamp is blinking. Doing so may damage the data in the internal memory or the card and render the internal memory or card unusable.

Card access lamp



AC adapter

An AC adapter is useful for time-consuming tasks such as image downloads to a computer or when running a slideshow for a long period of time. Do not use any other AC adapter with this camera.

Note

- Do not remove or load the battery or connect or disconnect the AC adapter while the camera is on or the camera is connected to the other equipment. Doing so could affect the camera's internal settings or functions.
- The AC adapter can be used within the range of AC 100 V to AC 240 V (50/60 Hz). When using the shape of abroad, you may need a plug adapter to convert the plug to match the AC wall outlet. For details, ask at your local electrical shop or travel agent.
- Do not use travel voltage converters as they could damage the AC adapter.
- Be sure to read the instruction manual for the AC adapter.

SAFETY PRECAUTIONS

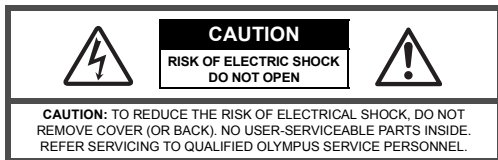

An exclamation mark enclosed in a triangle alerts you to important operating and maintenance instructions in the documentation provided with the product.



DANGER

If the product is used without observing the information given under this symbol, serious injury or death may result.



WARNING

If the product is used without observing the information given under this symbol, injury or death may result.



CAUTION

If the product is used without observing the information given under this symbol, minor personal injury, damage to the equipment, or loss of valuable data may result.

WARNING!

TO AVOID THE RISK OF FIRE OR ELECTRICAL SHOCK, NEVER DISASSEMBLE, EXPOSE THIS PRODUCT TO WATER OR OPERATE IN A HIGH HUMIDITY ENVIRONMENT.

General Precautions

Read All Instructions — Before you use the product, read all operating instructions. Save all manuals and documentation for future reference.

Cleaning — Always unplug this product from the wall outlet before cleaning. Use only a damp cloth for cleaning. Never use any type of liquid or aerosol cleaner, or any type of organic solvent to clean this product.

Attachments — For your safety, and to avoid damaging the product, use only accessories recommended by Olympus.

Water and Moisture — For precautions on products with weatherproof designs, read the weatherproofing sections.

Location — To avoid damage to the product, mount the product securely on a stable tripod, stand, or bracket.

Power Source — Connect this product only to the power source described on the product label.

Lightning — If a lightning storm occurs while using an AC adapter, remove it from the wall outlet immediately.

Foreign Objects — To avoid personal injury, never insert a metal object into the product.

Heat — Never use or store this product near any heat source such as a radiator, heat register, stove, or any type of equipment or appliance that generates heat, including stereo amplifiers.

Product Handling Precautions



WARNING

- Do not use the camera near flammable or explosive gases.
- Do not use the flash on people (infants, small children, etc.) at close range.
 - You must be at least 1 m (3 ft.) away from the faces of your subjects. Firing the flash too close to the subject's eyes could cause a momentary loss of vision.
- Keep young children and infants away from the camera.
 - Always use and store the camera out of the reach of young children and infants to prevent the following dangerous situations which could cause serious injury:
 - Becoming entangled in the camera strap, causing strangulation.
 - Accidentally swallowing the battery, cards or other small parts.
 - Accidentally firing the flash into their own eyes or those of another child.
 - Accidentally being injured by the moving parts of the camera.
- Do not look at the sun or strong lights with the camera.
- Do not use or store the camera in dusty or humid places.
- Do not cover the flash with a hand while firing.



CAUTION

- Stop using the camera immediately if you notice any unusual odors, noise, or smoke around it.
 - Never remove the batteries with bare hands, which may cause a fire or burn your hands.
- Never hold or operate the camera with wet hands.
- Do not leave the camera in places where it may be subject to extremely high temperatures.
 - Doing so may cause parts to deteriorate and, in some circumstances, cause the camera to catch fire. Do not use the charger or AC adapter if it is covered (such as a blanket). This could cause overheating, resulting in fire.
- Handle the camera with care to avoid getting a low-temperature burn.
 - When the camera contains metal parts, overheating can result in a low-temperature burn. Pay attention to the following:
 - When used for a long period, the camera will get hot. If you hold on to the camera in this state, a low-temperature burn may be caused.
 - In places subject to extremely cold temperatures, the temperature of the camera's body may be lower than the environmental temperature. If possible, wear gloves when handling the camera in cold temperatures.
- Be careful with the strap.
 - Be careful with the strap when you carry the camera. It could easily catch on stray objects - and cause serious damage.

Battery Handling Precautions

Follow these important guidelines to prevent batteries from leaking, overheating, burning, exploding, or causing electrical shocks or burns.



DANGER

- Use only the Olympus brand NiMH batteries and fitting charger.
- Never heat or incinerate batteries.
- Take precautions when carrying or storing batteries to prevent them from coming into contact with any metal objects such as jewelry, pins, fasteners, etc.
- Never store batteries where they will be exposed to direct sunlight, or subjected to high temperatures in a hot vehicle, near a heat source, etc.
- To prevent causing battery leaks or damaging their terminals, carefully follow all instructions regarding the use of batteries. Never attempt to disassemble a battery or modify it in any way, by soldering, etc.
- If battery fluid gets into your eyes, flush your eyes immediately with clear, cold running water and seek medical attention immediately.
- Always store batteries out of the reach of small children. If a child accidentally swallows a battery, seek medical attention immediately.

WARNING

- Keep batteries dry at all times.
- To prevent batteries from leaking, overheating, or causing a fire or explosion, use only batteries recommended for use with this product.
- Never mix batteries (old and new batteries, charged and uncharged batteries, batteries of different manufacture or capacity, etc.).
- Do not charge alkaline or lithium batteries if they are not rechargeable.
- Insert the battery carefully as described in the operating instructions.
- Do not use batteries if their body is not covered by the insulating sheet or if the sheet is torn, as this may cause fluid leaks, fire, or injury.

CAUTION

- Do not remove batteries immediately after using the camera. Batteries may become hot during prolonged use.
- Always unload the battery from the camera before storing the camera for a long period.

- The following AA batteries cannot be used.

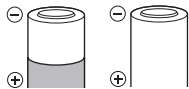

Batteries whose bodies are only partially or not at all covered by an insulating sheet.



Batteries whose \ominus terminals are raised, but not covered by an insulating sheet.

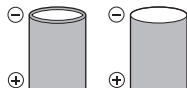

Batteries whose terminals are flat and not completely covered by an insulating sheet. (Such batteries cannot be used even if the \ominus terminals are partially covered.)

- If NiMH batteries are not charged within the specified time, stop charging them and do not use them.
- Do not use a battery if it is cracked or broken.
- If a battery leaks, becomes discolored or deformed, or becomes abnormal in any other way during operation, stop using the camera.
- If a battery leaks fluid onto your clothing or skin, remove the clothing and flush the affected area with clean, running cold water immediately. If the fluid burns your skin, seek medical attention immediately.
- Never subject batteries to strong shocks or continuous vibration.
- Olympus NiMH batteries (included in some areas) are intended for use only with Olympus digital cameras. Never use these batteries with any other device.
- Always charge NiMH batteries (included in some areas) before using them for the first time, or if they have not been used for a long period.
- Always charge sets of batteries (included in some areas) (2 or 4) together.
- Do not use alkaline batteries unless it is absolutely necessary. In some cases, alkaline batteries may have a shorter service life than NiMH battery packs. Alkaline battery performance is limited, especially at low temperatures. The use of NiMH batteries is recommended.
- CR-V3 lithium battery packs and AA manganese (Zinc-Carbon) batteries cannot be used with this camera.
- When operating the camera with battery power at low temperatures, try to keep the camera and spare batteries as warm as possible. Batteries which run down at low temperatures may be restored after they are warmed at room temperature.
- Recommended temperature ranges for NiMH batteries:
 - Operation..... 0°C to 40°C (32°F to 104°F)
 - Charge..... 0°C to 40°C (32°F to 104°F)
 - Storage..... -20°C to 30°C (-4°F to 86°F)
- Using, charging, or storing the batteries outside these ranges could shorten battery life or affect battery performance. Always unload the batteries from the camera before storing the camera for a long period.
- Before using NiMH or NiCd batteries, always read the provided instructions.
- The number of pictures you can take may vary depending on the shooting conditions or batteries.
- Before going on a long trip, and especially before traveling abroad, purchase an ample supply of extra batteries. The recommended batteries may be difficult to obtain while traveling.

Caution for Usage Environment

- To protect the high-precision technology contained in this product, never leave the camera in the places listed below, no matter if in use or storage:
 - Places where temperatures and/or humidity are high or go through extreme changes. Direct sunlight, beaches, locked cars, or near other heat sources (stove, radiator, etc.) or humidifiers.
 - In sandy or dusty environments.
 - Near flammable items or explosives.
 - In wet places, such as bathrooms or in the rain. When using products with weatherproof designs, read their manuals as well.
 - In places prone to strong vibrations.
- Never drop the camera or subject it to severe shocks or vibrations.
- When mounted on a tripod, adjust the position of the camera with the tripod head. Do not twist the camera.
- Do not touch electric contacts on cameras.
- Do not leave the camera pointed directly at the sun. This may cause lens or shutter curtain damage, color failure, ghosting on the CCD, or may possibly cause fires.
- Do not push or pull severely on the lens.
- Before storing the camera for a long period, remove the battery. Select a cool, dry location for storage to prevent condensation or mold from forming inside the camera. After storage, test the camera by turning it on and pressing the shutter release button to make sure that it is operating normally.
- Always observe the operating environment restrictions described in the camera's manual.

LCD Monitor

- Do not push the monitor forcibly; otherwise the image may become vague, resulting in a playback mode failure or damage to the LCD monitor.
- A strip of light may appear on the top/bottom of the monitor, but this is not a malfunction.
- When a subject is viewed diagonally in the camera, the edges may appear zigzagged on the monitor. This is not a malfunction; it will be less noticeable in playback mode.
- In places subject to low temperatures, the LCD monitor may take a long time to turn on or its color may change temporarily. When using the camera in extremely cold places, it is a good idea to occasionally place it in a warm place. An LCD monitor exhibiting poor performance due to low temperatures will recover in normal temperatures.
- The LCD used for the monitor is made with high-precision technology. However, black spots or bright spots of light may appear constantly on the LCD monitor. Due to its characteristics or the angle at which you are viewing the monitor, the spot may not be uniform in color and brightness. This is not a malfunction.

Legal and Other Notices

- Olympus makes no representations or warranties regarding any damages, or benefit expected by using this unit lawfully, or any request from a third person, which are caused by the inappropriate use of this product.
- Olympus makes no representations or warranties regarding any damages or any benefit expected by using this unit lawfully which are caused by erasing picture data.

Disclaimer of Warranty

- Olympus makes no representations or warranties, either expressed or implied, by or concerning any content of these written materials or software, and in no event shall be liable for any implied warranty of merchantability or fitness for any particular purpose or for any consequential, incidental or indirect damages (including but not limited to damages for loss of business profits, business interruption and loss of business information) arising from the use or inability to use these written materials or software or equipment. Some countries do not allow the exclusion or limitation of liability for consequential or incidental damages, so the above limitations may not apply to you.
- Olympus reserves all rights to this manual.

Warning

Unauthorized photographing or use of copyrighted material may violate applicable copyright laws. Olympus assumes no responsibility for unauthorized photographing, use or other acts that infringe upon the rights of copyright owners.

Copyright Notice

All rights reserved. No part of these written materials or this software may be reproduced or used in any form or by any means, electronic or mechanical, including photocopying and recording or the use of any type of information storage and retrieval system, without the prior written permission of Olympus. No liability is assumed with respect to the use of the information contained in these written materials or software, or for damages resulting from the use of the information contained therein. Olympus reserves the right to alter the features and contents of this publication or software without obligation or advance notice.

FCC Notice

•Radio and Television Interference

Changes or modifications not expressly approved by the manufacturer may void the user's authority to operate this equipment. This equipment has been tested and found to comply with the limits for a Class B digital device, pursuant to Part 15 of the FCC Rules. These limits are designed to provide reasonable protection against harmful interference in a residential installation.

This equipment generates, uses, and can radiate radio frequency energy and, if not installed and used in accordance with the instructions, may cause harmful interference to radio communications.

However, there is no guarantee that interference will not occur in a particular installation. If this equipment does cause harmful interference to radio or television reception, which can be determined by turning the equipment off and on, the user is encouraged to try to correct the interference by one or more of the following measures:

- Adjust or relocate the receiving antenna.
- Increase the distance between the camera and receiver.
- Connect the equipment to an outlet on a circuit different from that to which the receiver is connected.
- Consult your dealer or an experienced radio/TV technician for help. Only the OLYMPUS-supplied USB cable should be used to connect the camera to USB enabled personal computers (PC).

Any unauthorized changes or modifications to this equipment would void the user's authority to operate it.

For customers in North and South America

For customers in USA

Declaration of Conformity

Model Number : FE-210/X-775

Trade Name : OLYMPUS

Responsible Party : OLYMPUS IMAGING AMERICA INC.

Address : 3500 Corporate Parkway, P.O. Box 610, Center Valley,
PA 18034-0610, U.S.A.

Telephone Number: 484-896-5000

Tested To Comply With FCC Standards

FOR HOME OR OFFICE USE

This device complies with Part 15 of the FCC rules. Operation is subject to the following two conditions:

- (1) This device may not cause harmful interference.
- (2) This device must accept any interference received, including interference that may cause undesired operation.

For customers in Canada

This Class B digital apparatus meets all requirements of the Canadian Interference-Causing Equipment Regulations.

For customers in Europe



"CE" mark indicates that this product complies with the European requirements for safety, health, environment and customer protection. "CE" mark cameras are intended for sales in Europe.



This symbol [crossed-out wheeled bin WEEE Annex IV] indicates separate collection of waste electrical and electronic equipment in the EU countries. Please do not throw the equipment into the domestic refuse. Please use the return and collection systems available in your country for the disposal of this product.

Use Only Dedicated Rechargeable Battery and Battery Charger

We strongly recommend that you use only the genuine Olympus dedicated rechargeable battery and battery charger with this camera.

Using a non-genuine rechargeable battery and/or battery charger may result in fire or personal injury due to leakage, heating, ignition or damage to the battery. Olympus does not assume any liability for accidents or damage that may result from the use of a battery and/or battery charger that are not genuine Olympus accessories.

Provisions of warranty

1. If this product proves to be defective, although it has been used properly (in accordance with the written Handling Care and Operating instructions supplied with it), during a period of two years from the date of purchase from an authorized Olympus distributor within the business area of Olympus Imaging Europa GmbH as stipulated on the web site: <http://www.olympus.com> this product will be repaired, or at Olympus's option replaced, free of charge. To claim under this warranty the customer must take the product and this Warranty Certificate before the end of the two year warranty period to the dealer where the product was purchased or any other Olympus service station within the business area of Olympus Imaging Europa GmbH as stipulated on the web site: <http://www.olympus.com>. During the one year period of the World Wide Warranty the customer may turn the product in at any Olympus service station. Please notice that not in all countries such Olympus service station exists.
2. The customer shall transport the product to the dealer or Olympus authorized service station at his own risk and shall be responsible for any costs incurred in transporting the product.
3. This warranty does not cover the following and the customer will be required to pay repair charge, even for defects occurring within the warranty period referred to above.
 - (a) Any defect that occurs due to mishandling (such as an operation performed that is not mentioned in the Handling Care or other sections of the instructions, etc.)
 - (b) Any defect that occurs due to repair, modification, cleaning, etc. performed by anyone other than Olympus or an Olympus authorized service station.
 - (c) Any defect or damage that occurs due to transport, a fall, shock, etc. after purchase of the product.
 - (d) Any defect or damage that occurs due to fire, earthquake, flood damage, thunderbolt, other natural disasters, environmental pollution and irregular voltage sources.
 - (e) Any defect that occurs due to careless or improper storage (such as keeping the product under conditions of high temperature and humidity, near insect repellents such as naphthalene or harmful drugs, etc.), improper maintenance, etc.
 - (f) Any defect that occurs due to exhausted batteries, etc.
 - (g) Any defect that occurs due to sand, mud, etc. entering the inside of the product casing.
 - (h) When this Warranty Certificate is not returned with the product.
 - (i) When any alterations whatsoever are made to the Warranty Certificate regarding the year, month and date of purchase, the customer's name, the dealer's name, and the serial number.
 - (j) When proof of purchase is not presented with this Warranty Certificate.
4. This Warranty applies to the product only; the Warranty does not apply to any other accessory equipment, such as the case, strap, lens cap and batteries.
5. Olympus's sole liability under this warranty shall be limited to repairing or replacing the product. Any liability for indirect or consequential loss or damage of any kind incurred or suffered by the customer due to a defect of the product, and in particular any loss or damage caused to any lenses, films, other equipment or accessories used with the product or for any loss resulting from a delay in repair or loss of data, is excluded. Compelling regulations by law remain unaffected by this.

Notes regarding warranty maintenance

1. This warranty will only be valid if the Warranty Certificate is duly completed by Olympus or an authorized dealer or other documents contain sufficient proof. Therefore, please make sure that your name, the name of the dealer, the serial number and the year, month and date of purchase are all completed or the original invoice or the sales receipt (indicating the dealer's name, the date of purchase and product type) is attached to this Warranty Certificate. Olympus reserves the right to refuse free-of-charge service if neither Warranty Certificate is completed nor the above document is attached or if the information contained in it is incomplete or illegible.
2. Since this Warranty Certificate will not be re-issued, keep it in a safe place.
 - * Please refer to the list on the web site: <http://www.olympus.com> for the authorized international Olympus service network.

Trademarks

- IBM is a registered trademark of International Business Machines Corporation.
- Microsoft and Windows are registered trademarks of Microsoft Corporation.
- Macintosh is a trademark of Apple Computer Inc.
- xD-Picture Card™ is a trademark.
- All other company and product names are registered trademarks and/or trademarks of their respective owners.
- The standards for camera file systems referred to in this manual are the "Design Rule for Camera File System/DCF" standards stipulated by the Japan Electronics and Information Technology Industries Association (JEITA).

Specifications

● Camera

Product type	: Digital recording, JPEG (for shooting and displaying)
Recording system	
Still pictures	: Digital recording, JPEG (in accordance with Design rule for Camera File system (DCF))
Applicable standards	: Exif 2.2, Digital Print Order Format (DPOF), PRINT Image Matching III, PictBridge
Movie	: AVI Motion JPEG
Memory	: Internal memory xD-Picture Card (16 MB to 2 GB) (Type H/M, Standard)
Number of effective pixels	: 7,100,000 pixels
Image pickup device	: 1/2.5" CCD (primary color filter), 7,400,000 pixels (gross)
Lens	: Olympus lens 6.3 to 18.9 mm, f3.1 to 5.9 (equivalent to 38 to 114 mm on a 35 mm camera)
Photometric system	: Center-weighted metering
Shutter speed	: 4 to 1/2,000 sec.
Shooting range	: 0.6 m (2.0 ft.) to ∞ (W), 1.0 m (3.3 ft.) to ∞ (T) (normal) 0.1 m (0.3 ft.) to ∞ (W), 0.6 m (2.0 ft.) to ∞ (T) (macro mode) 0.05 m (2.0 in.) to ∞ (super macro mode)
Monitor	: 2.5" TFT color LCD display, 154,000 pixels
Outer connector	: DC-IN jack, USB connector, VIDEO OUT jack
Automatic calendar system	: 2000 up to 2099
Operating environment	
Temperature	: 0 °C to 40 °C (32 °F to 104 °F) (operation)/ -20 °C to 60 °C (-4 °F to 140 °F) (storage)
Humidity	: 30 % to 90 % (operation)/10 % to 90 % (storage)
Power supply	: AA batteries 2 each (Oxyride batteries/Alkaline battery/ NiMH battery) or specified AC adapter
Dimensions	: 90 mm (W) × 62.5 mm (H) × 30.5 mm (D) (3.5 × 2.5 × 1.2 in.) (excluding protrusions)
Weight	: 122 g (4.3 oz) (without battery and card)

Please note that design and specification improvements may result in unannounced changes.

Camera diagram

Camera

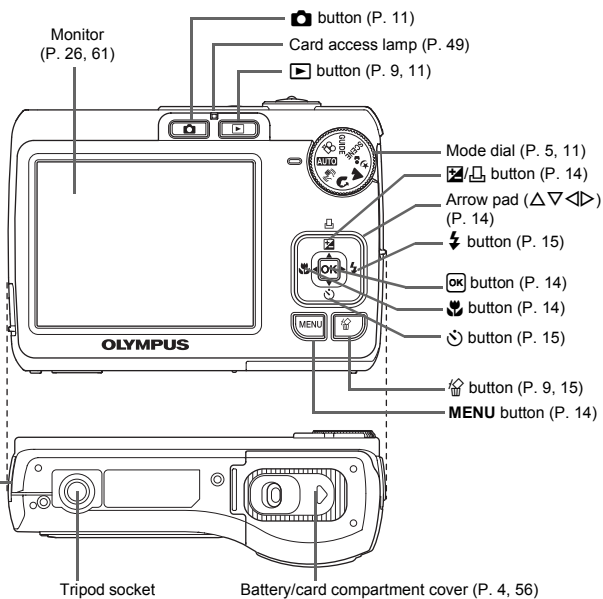
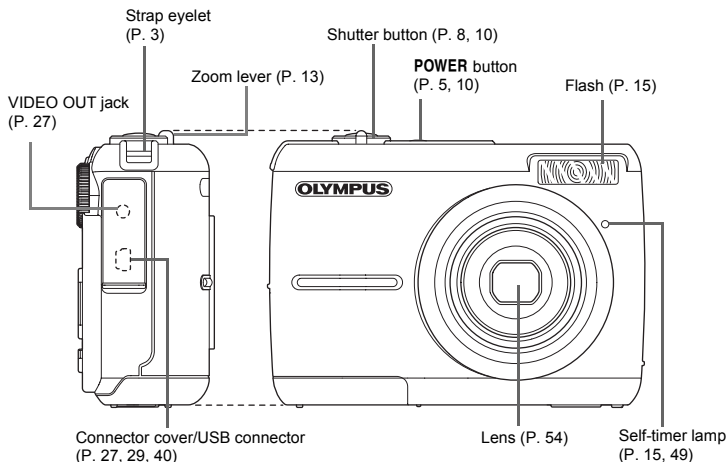

Monitor symbols and icons

● Shooting mode

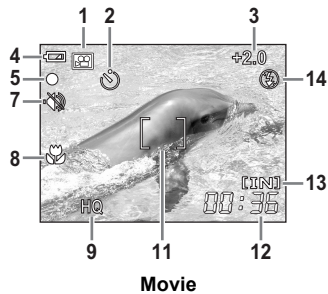
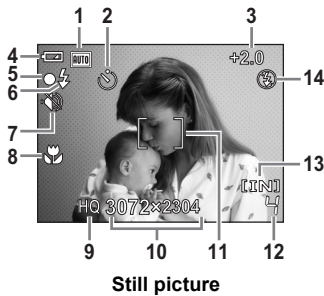

	Item	Indications	Ref. page
1	Shooting mode	AUTO, (M), (S), (A), (P), (L), etc.	P. 5, 18
2	Self-timer	⌚	P. 15
3	Exposure compensation	-2.0 – +2.0	P. 14
4	Battery check	🔋 (full power), 🔋 (low power)	P. 51
5	Green lamp	⦿ (Auto Focus Lock)	P. 8, 49
6	Flash standby Camera movement warning/flash charge	⚡ (Lit) ⚡ (Blinks)	P. 45
7	Silent mode	🔇	P. 20
8	Macro mode Super macro mode	🌸 SM	P. 14
9	Image quality	SHQ, HQ, SQ1, SQ2, 16:9	P. 19
10	Image size	3072 × 2304, 2048 × 1536, 1920 × 1080, 640 × 480	P. 19
11	AF target mark	[]	P. 8
12	Number of storable still pictures Remaining recording time	4 00:36	P. 48
13	Current memory	[IN] (Recording pictures to the internal memory), [xD] (Recording pictures to the card)	P. 55
14	Flash mode	👁️, ⚡, 🔋	P. 15

● Playback mode

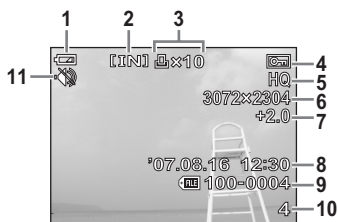

Still picture



Movie

	Item	Indications	Ref. page
1	Battery check	(full power), (low power)	P. 51
2	Current memory	[IN] (Playing back the pictures in the internal memory), [xD] (Playing back the pictures in the the card)	P. 55
3	Print reservation/ number of prints	×10	P. 34
	Movie		P. 21
4	Protect		P. 22
5	Image quality	SHQ, HQ, SQ1, SQ2, 16:9	P. 19
6	Image size	3072 × 2304, 2048 × 1536, 640 × 480 etc.	P. 19
7	Exposure compensation	-2.0 – +2.0	P. 14
8	Date and time	'07.08.16 12:30	P. 6
9	File number	100-0004	—
10	Frame number Elapsed time/Total recording time (movie)	4 00:00/00:36	P. 21
11	Silent mode		P. 20

Index

button (Erase).....	9, 15
button (Exposure compensation/Print).....	14, 29
button (Flash mode).....	15
button (Macro).....	14
button (OK).....	14, 16
button (Playback).....	9, 11
button (Self-timer).....	15
button (Shooting).....	11
.....	26
AUTO (Auto).....	5, 11
(D IMAGE STABILIZATION).....	5, 11
(LANDSCAPE).....	5, 11
(Movie).....	11, 12
(NIGHT+PORTRAIT).....	5, 11
(POPPORTRAIT).....	5, 11
16:9.....	19

A

AC adapter.....	57
ADD FAVORITE.....	24
ALL ERASE.....	23
ALL INDEX.....	31
ALL PRINT.....	31
All-frame reservation	35
Arrow pad ().....	14, 16
AUCTION	12
Auto focus.....	46

B

BACKUP.....	25
Battery.....	4, 54
Battery check.....	67
BEEP.....	26
BEHIND GLASS	12

C

CANDLE	12
Card.....	25, 55

Card access lamp.....	42, 49, 57
CCD.....	26
Close-up playback	13
Compression.....	19
Connector cover.....	27, 29, 40
CUISINE	12
CUSTOM PRINT.....	30

D

Date and time	6, 26, 45
Digital zoom.....	13
Direct print.....	28
DOCUMENTS	12
DPOF.....	33

E

















EASY PRINT.....	28
ERASE.....	23
Error message.....	51
EXIT.....	24
Exposure.....	10
Exposure compensation	14





F

File name.....	26
Fill-in flash	15
FIREWORKS	12
Flash.....	15
Flash auto AUTO	15
Flash charge.....	45
Flash mode	15
Flash off	15
Focus.....	8, 10, 46, 49
Focus lock.....	10
FORMAT.....	25
Format.....	25

G

Green lamp.....	8, 10, 46, 49
-----------------	---------------

GUIDE (Shooting guide)	5, 12	PC	40
H		PictBridge	28
HQ	19	PIXEL MAPPING	26
I		PLAYBACK MENU	22
IMAGE QUALITY	19, 49	Playback mode 	9, 11, 21, 68
Image size	19	Playback on TV	27
Index display 	13	Playing time	21
INDOOR 	12	POWER button	5, 10
Internal memory	25, 48, 50, 55	Press completely	8, 10
M		Press halfway	8, 10
Macro mode 	14	PRINT ORDER	31
MEMORY FORMAT	25	PRINT ORDER 	24
Menu	16, 17	Print settings	33
MENU button	14, 16	Protect 	22
Mode dial	5, 11	R	
Monitor	10, 26, 67	Recording movies 	11, 12
Monitor brightness adjustment 	26	Red-eye reduction flash 	15
MOVIE PLAY	21	Remaining recording time	12, 48
MULTI PRINT	31	RESET	20, 50
MY FAVORITE	23	RESIZE 	23
N		Rotate 	22
NiMH batteries	54	S	
NTSC	27	SCENE (Scene)	5, 12, 20
Number of storable still pictures	48	SEL. IMAGE	23
O		Selecting a language 	25
OLYMPUS Master	37, 41	SELF PORTRAIT 	12
Operation guide	17, 30	Self-timer lamp	15, 49
Optical zoom	13	Self-timer 	15
P		SET	24
PAL	27	SETUP	25
PANORAMA	19	Shooting mode 	5, 11, 18, 67
		Shooting still pictures	10
		SHQ	19
		Shutter button	8, 10
		SILENT MODE 	20
		Single-frame playback	13

Single-frame reservation 	34
Sleep mode	45
SLIDESHOW	21, 24
SPORT 	12
SQ1	19
SQ2	19
STANDARD	28
SUNSET 	12
Super macro mode 	14

T

Top Menu	16
Total recording time	21

U

USB cable	3, 29, 37, 40
USB connector	29, 40
USB driver	44

V

Video cable	3, 27
VIDEO OUT	27
VIDEO OUT jack	27
VIEW FAVORITES	24

X

xD-Picture Card	19, 55
-----------------	--------

Z

Zoom	13
Zoom lever	13



<http://www.olympus.com/>

OLYMPUS IMAGING CORP.

Shinjuku Monolith, 3-1 Nishi-Shinjuku 2-chome, Shinjuku-ku, Tokyo, Japan

OLYMPUS IMAGING AMERICA INC.

3500 Corporate Parkway, P.O. Box 610, Center Valley, PA 18034-0610, U.S.A. Tel. 484-896-5000

Technical Support (USA)

24/7 online automated help: <http://www.olympusamerica.com/support>

Phone customer support: Tel. 1-888-553-4448 (Toll-free)

Our phone customer support is available from 8 am to 10 pm

(Monday to Friday) ET

E-Mail: distec@olympus.com

Olympus software updates can be obtained at: <http://www.olympusamerica.com/digital>

OLYMPUS IMAGING EUROPA GMBH

Premises: Wendenstrasse 14-18, 20097 Hamburg, Germany

Tel: +49 40-23 77 3-0 / Fax: +49 40-23 07 61

Goods delivery: Bredowstrasse 20, 22113 Hamburg, Germany

Letters: Postfach 10 49 08, 20034 Hamburg, Germany

European Technical Customer Support:

Please visit our homepage <http://www.olympus-europa.com>

or call our TOLL FREE NUMBER* : **00800 - 67 10 83 00**

for Austria, Belgium, Denmark, Finland, France, Germany, Italy, Luxemburg, Netherlands,
Norway, Portugal, Spain, Sweden, Switzerland, United Kingdom

* Please note some (mobile) phone services providers do not permit access or request an
additional prefix to +800 numbers.

For all European Countries not listed and in case that you can't get connected

to the above mentioned number, please make use of the following

CHARGED NUMBERS: **+49 180 5 - 67 10 83** or **+49 40 - 237 73 899**

Our Technical Customer Support is available from 9 am to 6 pm MET (Monday to Friday)