

# Quick Start Guide FE-210/X-775

## Start Here

For more information, please refer to the Basic & Advanced Manuals or visit: [www.olympusamerica.com/support](http://www.olympusamerica.com/support)

OLYMPUS IMAGING AMERICA INC.

© 2007 OLYMPUS IMAGING CORP.  
Printed in China

VH929001

### 1 Gather these items (box contents)

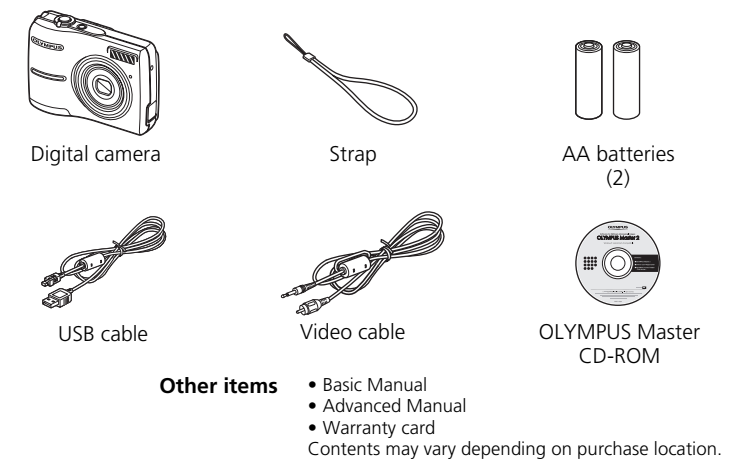

#### Attach the strap

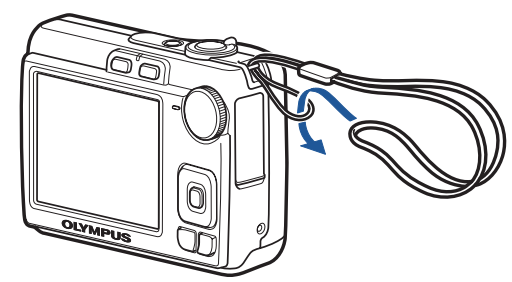

● Pull the strap tight so that it does not come loose.

### 2 Insert the batteries

a. Insert the batteries into the camera.

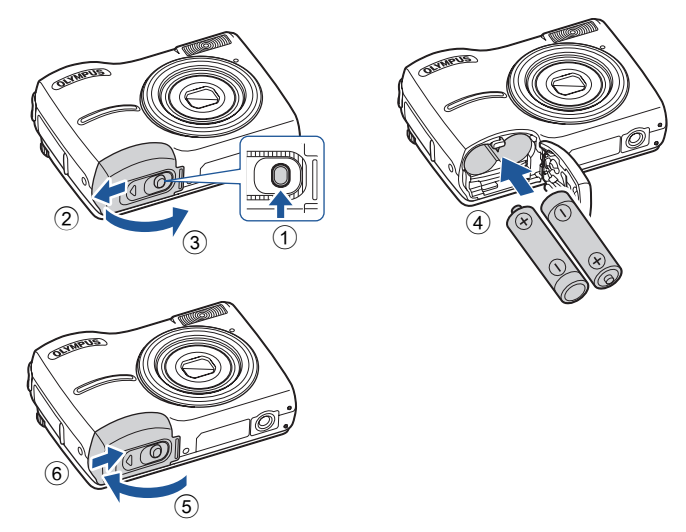

● Even when an optional xD-Picture Card™ (hereinafter called the card) is not inserted, you can take a picture. For details on inserting an optional card, please refer to Advanced Manual.

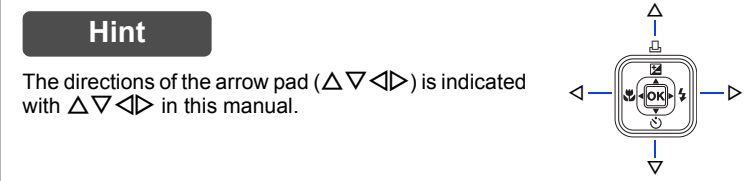

### 3 Turn the camera on

This explains how to turn on the camera in shooting mode.

a. Set the mode dial to **AUTO**.

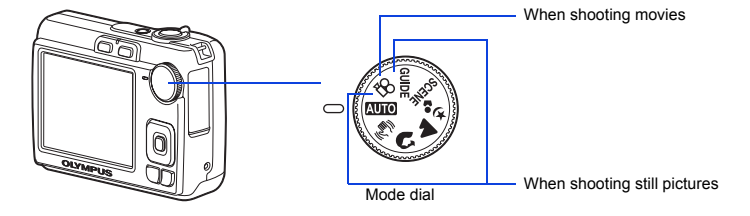

**Still picture shooting modes**

<b>AUTO</b>	This function allows you to shoot with the camera's automatic settings.
	This function stabilizes images when taking pictures.
	Suitable for taking pictures of people.
	Suitable for taking pictures of landscapes.
	Suitable for taking pictures of people at night.
<b>SCENE</b>	Select from 10 scene modes according to the shooting conditions.
<b>GUIDE</b>	Use the shooting guide displayed on the screen to shoot pictures according to the situation.

b. Press the **POWER** button.

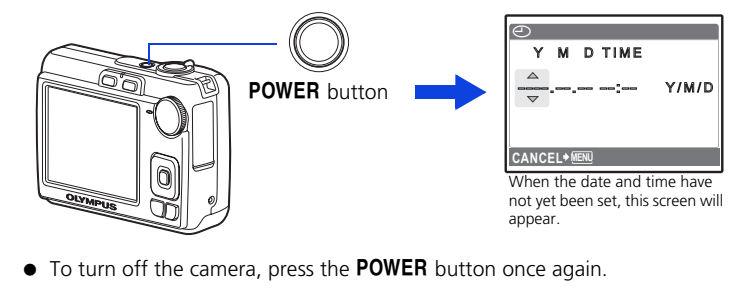

● To turn off the camera, press the **POWER** button once again.

### 4 Set date and time

#### About the date and time setting screen

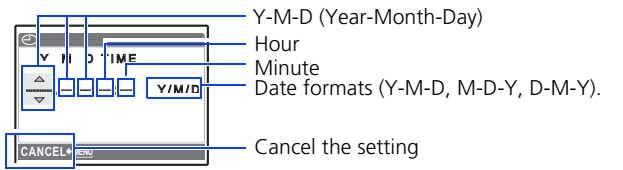

a. Press the and the to select [Y].

- The first two digits of [Y] are fixed.

b. Press the button.

c. Press the and the to select [M].

d. Press the button.  
e. Press the and the to select [D].

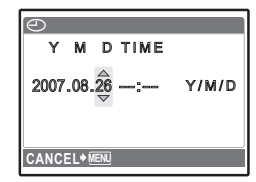

f. Press the button.  
g. Press the and the to select "hour" and "minute".

- The time is displayed in the 24-hour format.

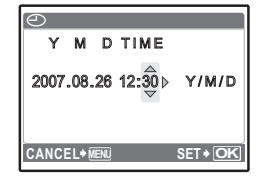

h. Press the button.  
i. Press the and the to select [Y/M/D].

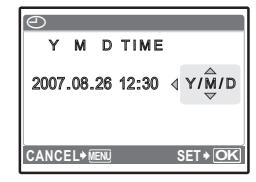

j. After all items have been set, press the **OK** button.

- For a more accurate setting, you can press the **OK** button when the time signal hits 00 seconds.

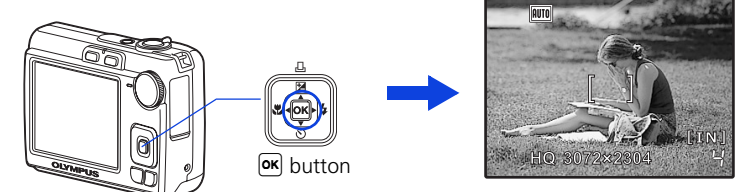

### 5 Take a picture

a. Hold the camera.



b. Focus.

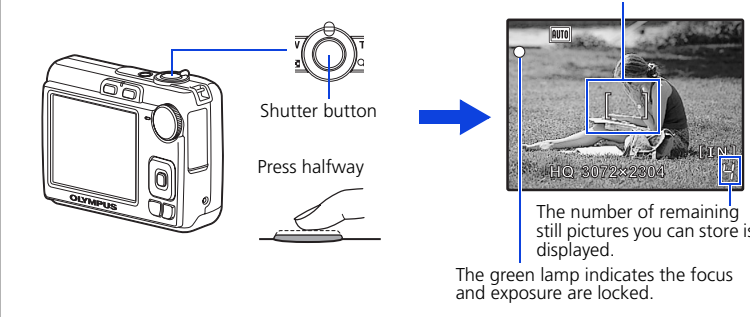

c. Shoot.

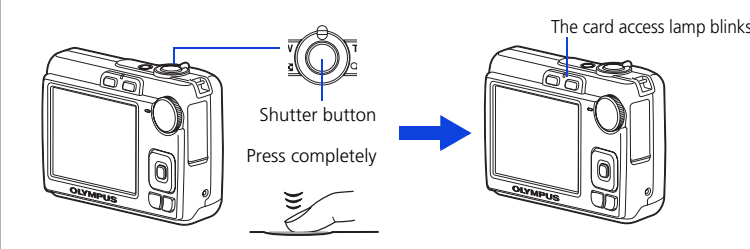

### 6 Review your pictures

a. Press the button.

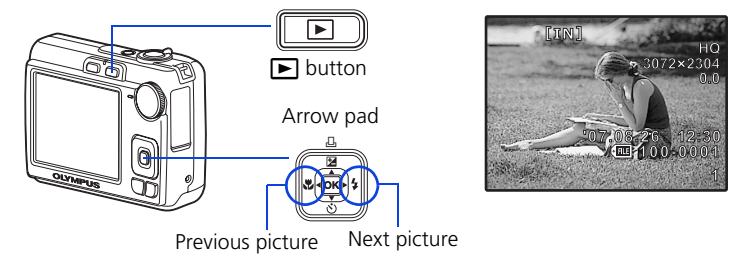

#### Erase pictures

a. Press the and the to display the picture you want to erase.  
b. Press the button.

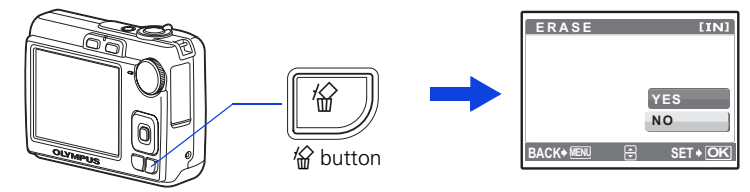

c. Press the to select [YES], and press the **OK** button.

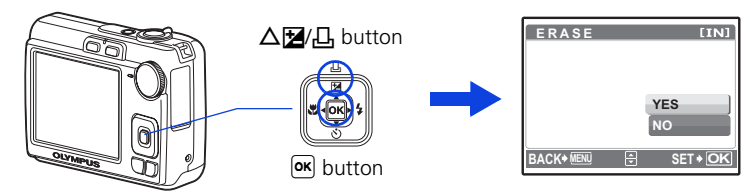

# Guia de Iniciação Rápido FE-210/X-775

## Começar aqui

Para maiores informações, consulte os Manuais Básico e Avançado ou visite a página web: [www.olympusamerica.com/support](http://www.olympusamerica.com/support)

OLYMPUS IMAGING AMERICA INC.

## 1 Reunir estes itens (conteúdo da embalagem)

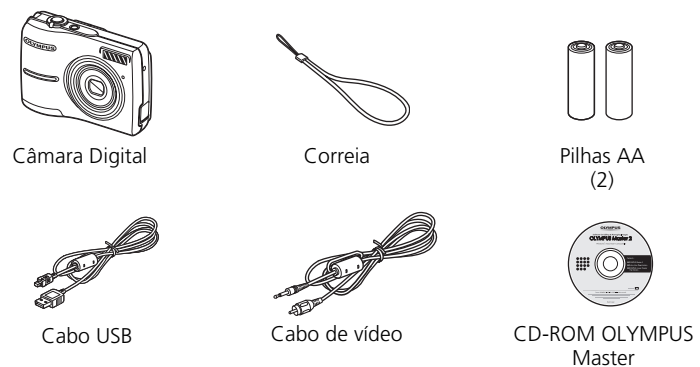

**Outros itens**

- Manual Básico
- Manual Avançado
- Cartão de garantia
- O conteúdo pode variar conforme o local de aquisição.

### Colocar a correia

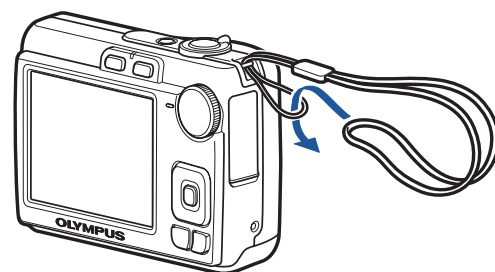

• Puxe bem a correia de modo a que não fique solta.

## 2 Inserir as pilhas

a. Insira as pilhas na câmara.

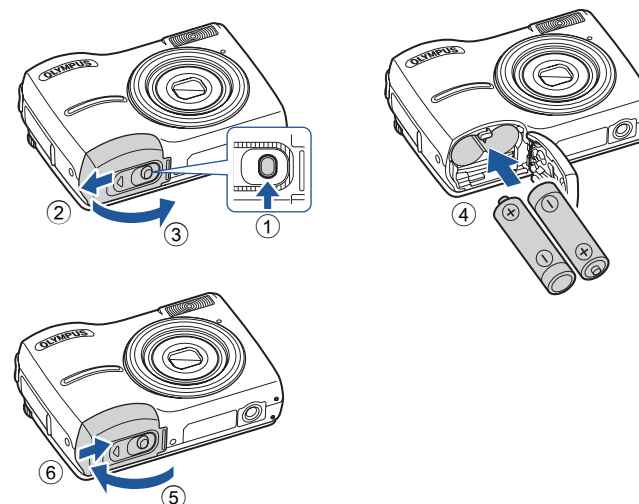

• Mesmo quando um cartão xD-Picture Card™ (designado a partir de aqui apenas por cartão) não estiver inserido, pode tirar fotografias. Quanto aos detalhes sobre a inserção de um cartão opcional, consulte o Manual Avançado.

### Sugestão

As direcções do selector em cruz (Δ ∇ ◀ ▶) estão indicadas, neste manual, com Δ ∇ ◀ ▶.

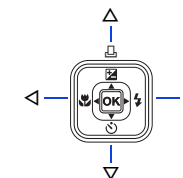

## 3 Ligar a câmara

Este modo explica como ligar a câmara no modo fotografia.

a. Ajuste o selector de modo para **AUTO**.

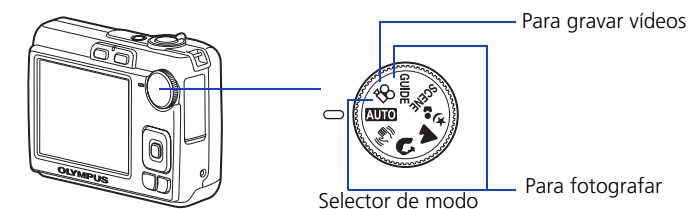

### Modos de fotografia

<b>AUTO</b>	Esta função permite tirar fotografias com as definições automáticas da câmara.
	Esta função estabiliza as imagens ao tirar fotografias.
	Indicado para fotografar fotografias tipo retrato.
	Indicado para fotografar paisagens.
	Indicado para fotografar pessoas à noite.
<b>SCENE</b>	Seleccionar de entre 10 modos de cena mediante as condições fotográficas.
<b>GUIDE</b>	Usar o assistente de fotografia, visualizado no ecrã, para fotografar imagens mediante a situação.

b. Prima o botão **POWER**.

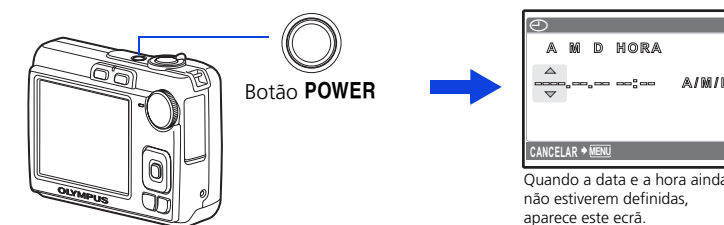

• Para desligar a câmara, premir novamente o botão **POWER**.

## 4 Acertar data e hora

### Acerca do ecrã de acerto da data e da hora

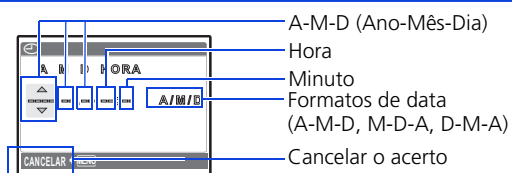

a. Prima o botão Δ ◀ ▶ e o botão ∇ ☺ para seleccionar [A].

• Os primeiros dois dígitos de [A] são fixos.

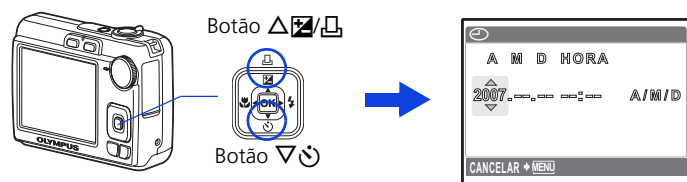

b. Prima o botão Δ ◀ ▶.

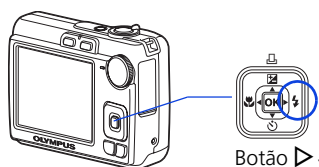

c. Prima o botão Δ ◀ ▶ e o botão ∇ ☺ para seleccionar [M].



d. Prima o botão ▶ ⚡.

e. Prima o botão Δ ◀ ▶ / ☺ e o botão ∇ ☺ para seleccionar [D].



f. Prima o botão ▶ ⚡.

g. Prima o botão Δ ◀ ▶ / ☺ e o botão ∇ ☺ para seleccionar "hora" e "minuto".

• A hora é exibida no formato de 24 horas.



h. Prima o botão ▶ ⚡.

i. Prima o botão Δ ◀ ▶ / ☺ e o botão ∇ ☺ para seleccionar [A/M/D].



j. Depois de configuradas todas as definições, prima o botão **OK**.

• Para definir a hora exacta, prima o botão **OK** até que o sinal da hora atinja os 00 segundos.

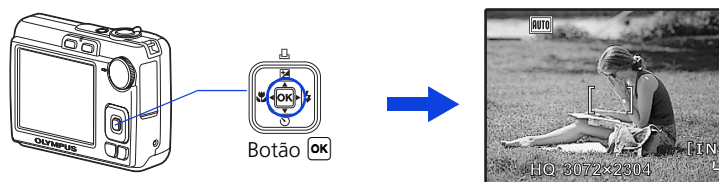

## 5 Fotografar

a. Segurar a câmara.

Segurar na horizontal

Segurar na vertical

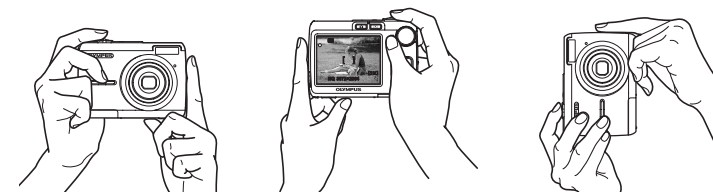

b. Focar.

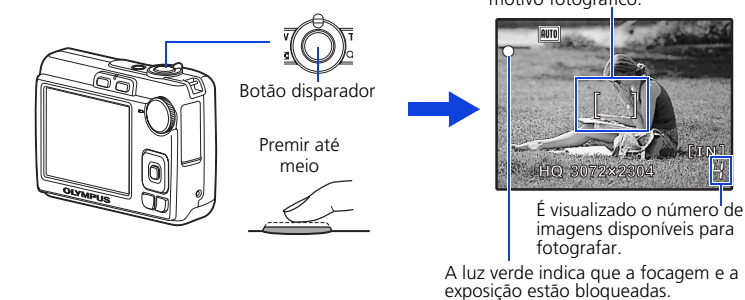

c. Fotografar.

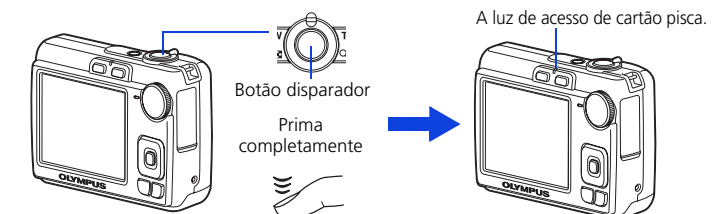

## 6 Ver as suas imagens

a. Prima o botão ▶.

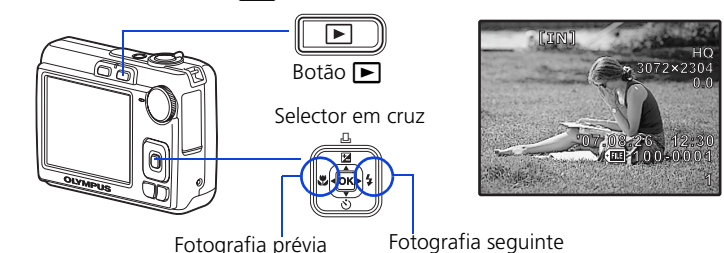

### Apagar imagens

a. Prima o botão ◀ ☺ e o botão ▶ ⚡ de modo a visualizar a imagem que pretende apagar.

b. Prima o botão ☺.

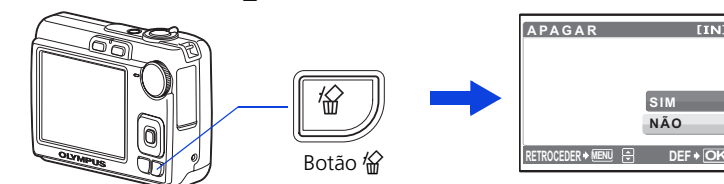

c. Prima o botão Δ ◀ ▶ / ☺ para seleccionar [SIM] e então prima o botão **OK**.

