

DIGITAL CAMERA

OLYMPUS[®]

SP-570UZ

Instruction Manual

Quick Start Guide

This manual will help you get started using your camera right away.

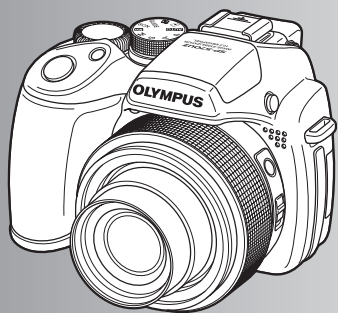

Button operations

Menu operations

Printing pictures

Using OLYMPUS Master

Getting to know your
camera better

Appendix

- Thank you for purchasing an Olympus digital camera. Before you start to use your new camera, please read these instructions carefully to enjoy optimum performance and a longer service life. Keep this manual in a safe place for future reference.
- We recommend that you take test shots to get accustomed to your camera before taking important photographs.
- In the interest of continually improving products, Olympus reserves the right to update or modify information contained in this manual.
- The screen and camera illustrations shown in this manual were produced during the development stages and may differ from the actual product.

Contents

Quick Start Guide	P.3	
Camera diagram	P.11	Learn the names of the camera parts and get a general grasp of the camera's functions. Use this section as reference for the functions.
Button operations	P.16	Test out the functions of the camera buttons by following the illustrations and trying them out on the camera.
Operations using the control panel	P.29	Learn how to use the control panel to perform basic operations, and then try them out.
Menu operations	P.32	Learn everything about the menus, from basic operations to the functions of each menu and their various settings.
Printing pictures	P.59	Learn how to print pictures you have taken.
Using OLYMPUS Master	P.64	Learn how to transfer and save pictures to a computer.
Getting to know your camera better	P.68	Find out more about your camera and learn what to do when you have a question regarding operations.
Appendix	P.81	Read about convenient functions and safety precautions on how to use your camera more effectively.

Gather these items (box contents)



Digital Camera



Lens Cap
Lens Cap String

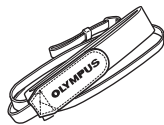

Strap



AA Batteries (four)

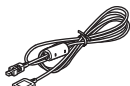

USB cable

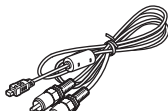

AV Cable



OLYMPUS Master2
CD-ROM

Items not shown: Instruction Manual (this manual), warranty card.
Contents may vary depending on purchase location.

Attach the strap and the lens cap

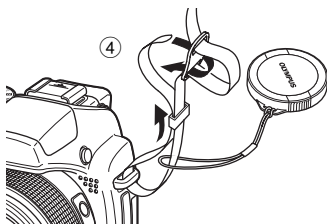
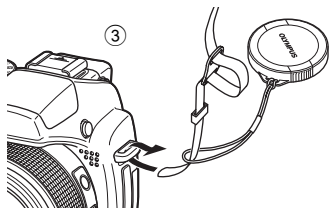
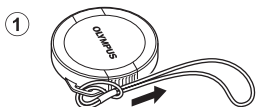

- Attach the strap to the other eyelet in the same manner.

- Pull the strap tight so that it does not come loose.

Prepare the camera

a. Load batteries into the camera

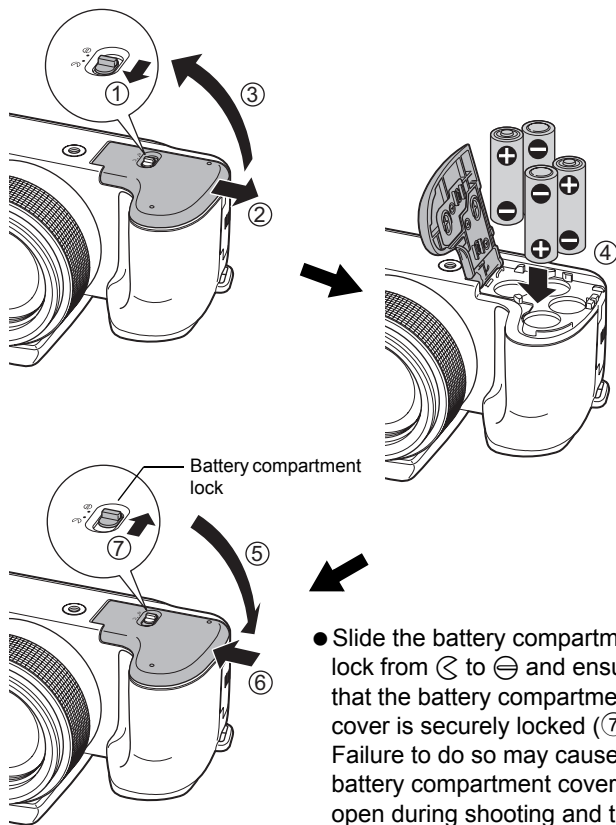

- Slide the battery compartment lock from ⊂ to ⊖ and ensure that the battery compartment cover is securely locked (7). Failure to do so may cause the battery compartment cover to open during shooting and the batteries to fall out, resulting in loss of image data.

b. Insert the (optional) xD-Picture Card into the camera

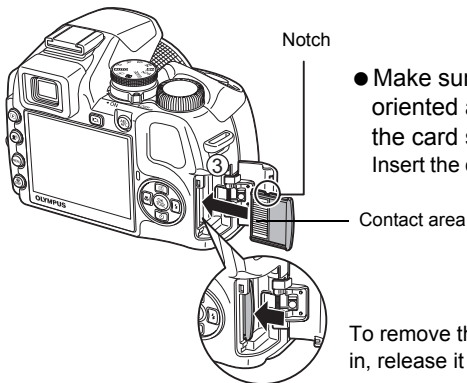
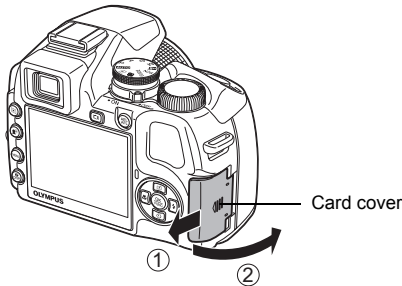

- Make sure the card is correctly oriented and insert it straight into the card slot. Insert the card until it clicks into place.

To remove the card, push it all the way in, release it slowly and remove.

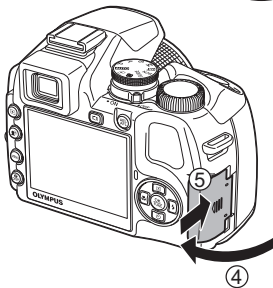

- This camera allows you to take pictures without using an optional xD-Picture Card™ (hereinafter called the card). When taking pictures without the card, pictures will be stored in the internal memory. For details on the card, please refer to "The card" (P.85).

Turn the camera on

This explains how to turn on the camera in shooting mode.

a. Set the mode dial to **AUTO**.

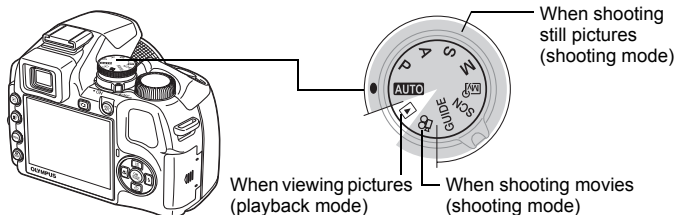

Still picture shooting modes

AUTO	The camera determines the optimum settings for the shooting conditions automatically.
P	The camera automatically sets the optimum aperture value and shutter speed.
A	This function allows you to change the aperture manually.
S	This function allows you to change the shutter speed manually.
M	This function allows you to change the aperture and shutter speed manually.
M₁	This function allows you to set each shooting function manually and use as your original shooting mode.
SCN	This function allows you to shoot pictures by selecting a scene according to the shooting condition.
GUIDE	This function allows you to set the target items by following the shooting guide displayed on the screen.

b. Remove the lens cap and set the camera's power switch to ON.

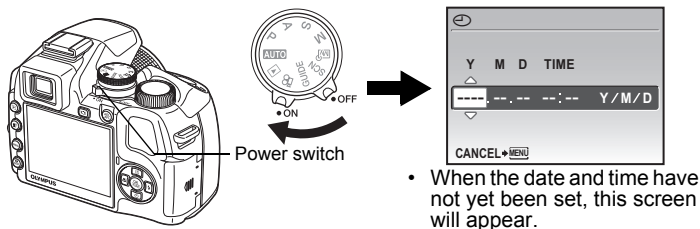

- To turn off the camera, set the power switch to OFF.

Tips

The directions of the arrow pad are indicated with  in this manual.

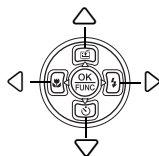

Set date and time

About the date and time setting screen

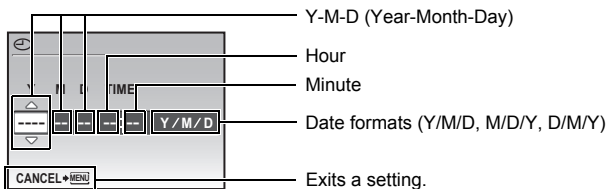

- a. Press the button and the button to select [Y].

- The first two digits of [Y] are fixed.

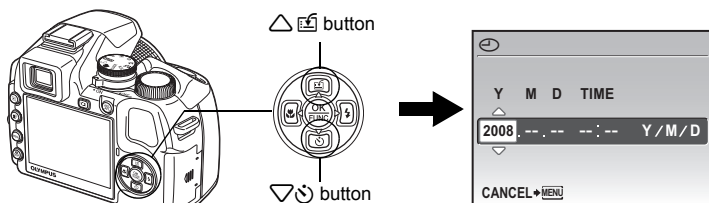

- b. Press the button.

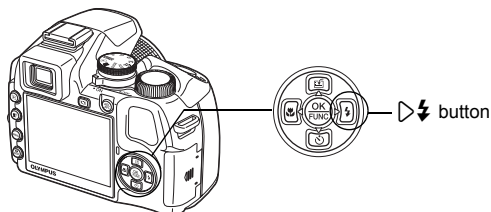

- c. Press the button and the button to select [M].

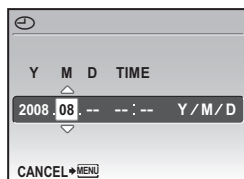

- d. Press the button.
- e. Press the button and the button to select [D].

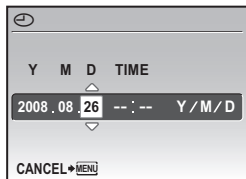

- f. Press the button.
- g. Press the button and the button to select the hours and minutes.
- The time is displayed in the 24-hour format.

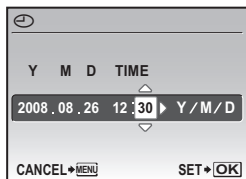

- h. Press the button.
- i. Press the button and the button to select [Y/M/D].

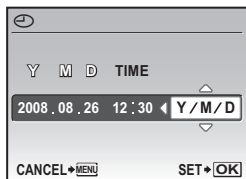

- j. After all items have been set, press the button.
- For precise time setting, press the button as the time signal strikes 00 seconds.

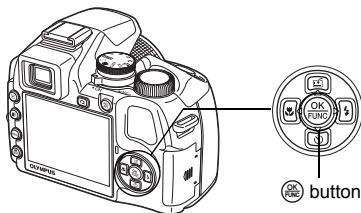

The number of remaining still pictures is displayed.

Take a picture

a. Hold the camera

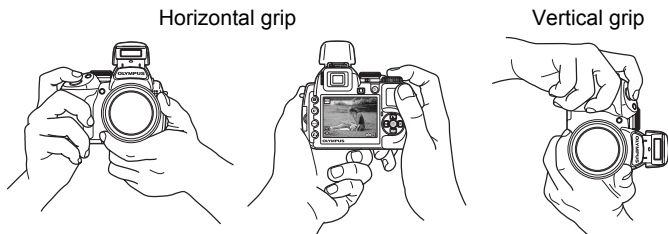

b. Focus

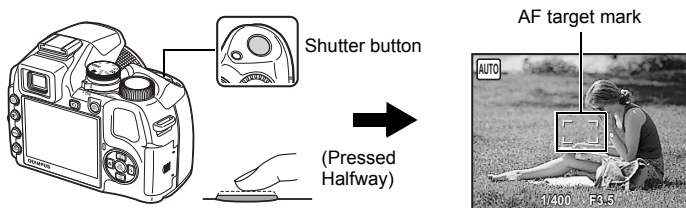

- The AF target mark lights in green when the focus and exposure are locked. The shutter speed and aperture value are displayed.
- If the AF target mark blinks in red, the focus is not adjusted properly. Try locking the focus again.

c. Shoot

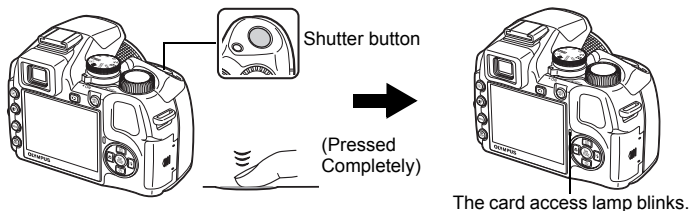

Adjusting the viewfinder's focus using the diopter

a. Press the button.

b. While looking through the viewfinder, rotate the diopter adjustment dial little by little.

- When you can see the icons in the viewfinder clearly, adjustment is complete.

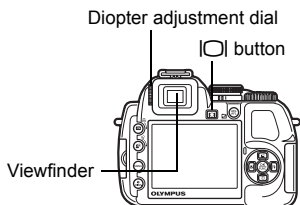





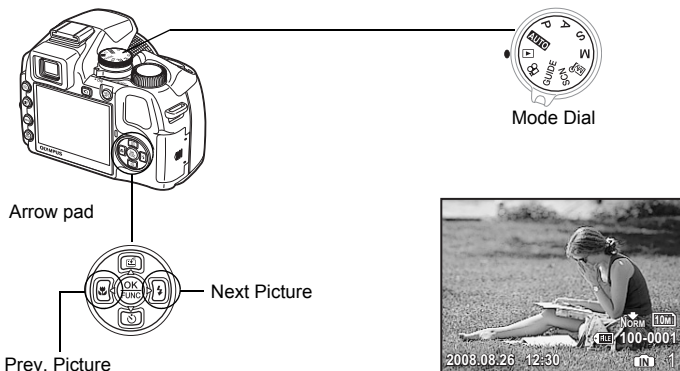

View pictures



- a. Set the mode dial to .

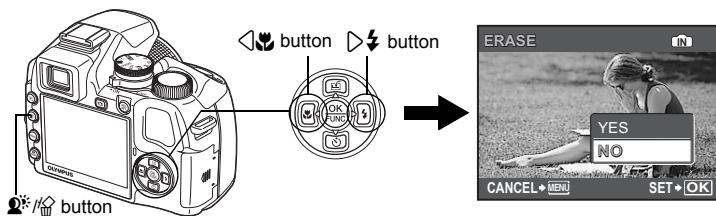

Erase pictures

- a. Press the   button and the   button to display the picture you want to erase.
- b. Press the   button.



- c. Press the   button to select [YES], and press the  button to erase the picture.

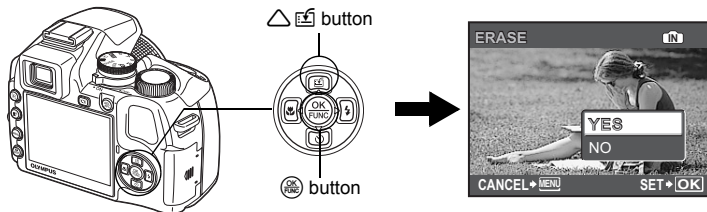

Camera diagram

Camera

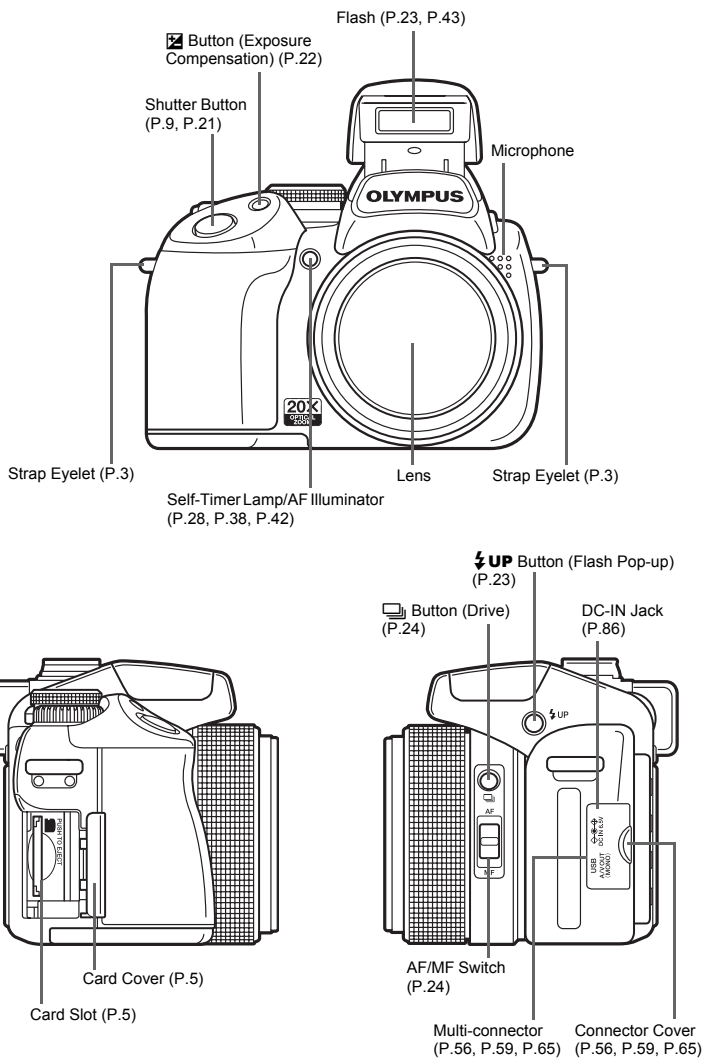

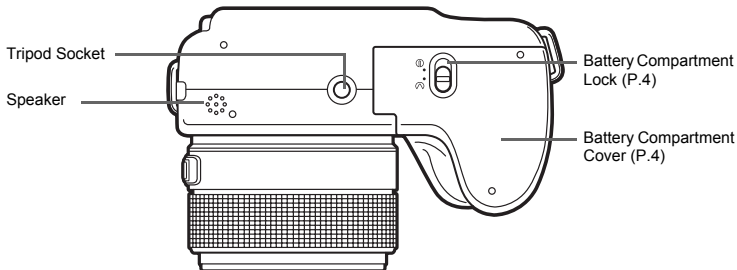
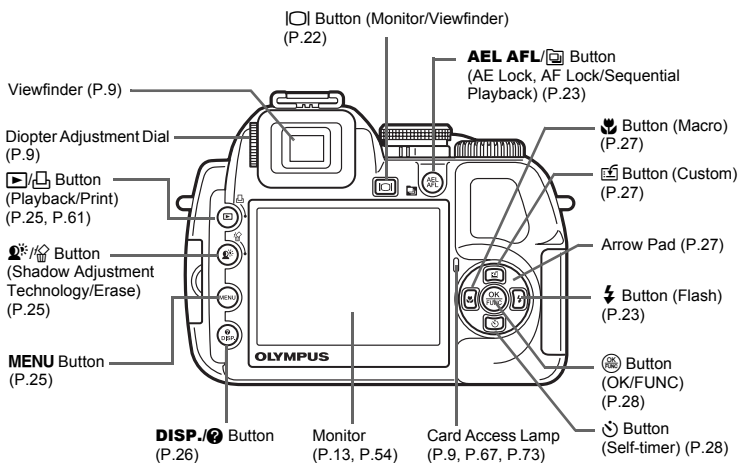
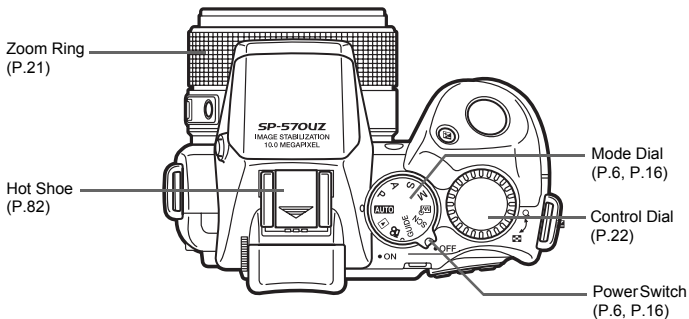

Monitor Symbols & Icons

● Shooting mode

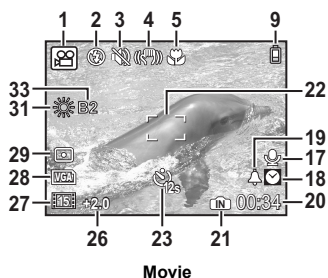
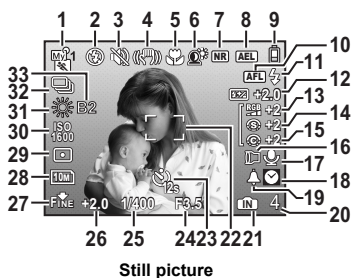

	Item	Indication	Ref. Page
1	Shooting mode	, , , , , , etc.	P.6, P.16, P.37
2	Flash mode	, , , etc.	P.23
3	Silent mode		P.45
4	Digital image stabilization		P.42
5	Macro mode Super macro mode	 	P.27
6	Shadow Adjustment Technology		P.25
7	Noise reduction		P.44
8	AE lock mark		P.23
9	Battery check	= full power, = low power	P.76
10	AF lock mark Manual focus AF predict	 	P.23 P.24 P.42
11	Flash standby Camera movement warning/Flash charge	Lit Blinks	P.68
12	Flash intensity control	-2.0 - +2.0	P.42
13	Saturation	-5 - +5	P.44
14	Sharpness	-5 - +5	P.44
15	Contrast	-5 - +5	P.44
16	Conversion lens		P.45
17	Sound record		P.50
18	Dual time		P.55
19	Alarm		P.55
20	Number of storable still pictures Remaining recording time	4 00:34	P.8 P.72

	Item	Indication	Ref. Page
21	Current memory	: Pictures are recorded to the internal memory No indication: Pictures are recorded to the card	P.85
22	AF target mark		P.9, P.21, P.41
23	Self-timer	,	P.28
24	Aperture value	F2.8 to F8.0	P.17
25	Shutter speed	15", 1/2, 1/400, 1/2000, BULB, etc.	P.17
26	Exposure compensation	-2.0 - +2.0	P.22
27	Image quality Compression Frame rate	RAW , Normal (Normal), Fine (Fine) (15 frames/sec.), (30 frames/sec.)	P.34 P.34 P.35
28	Image size	, , , , etc.	P.34
29	Spot metering	,	P.41
30	ISO	ISO 100, ISO 800, ISO 1600 etc.	P.40
31	White balance	, , , , ,	P.39
32	Drive	, , , , , , BKT	P.24, P.40
33	White balance compensation	B1 - B7, R1 - R7	P.43

● Playback mode

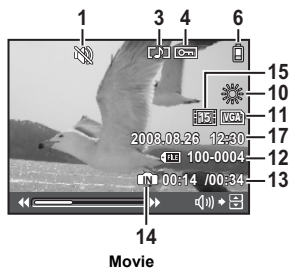
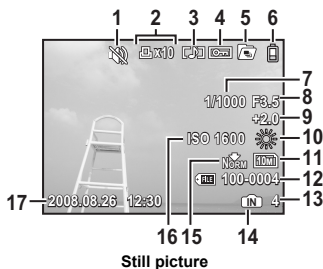

	Item	Indication	Ref. Page
1	Silent mode		P.45
2	Print reservation/Number of prints	x10	P.62
3	Sound record		P.50
4	Protect		P.50
5	Sequential Playback/Sequential Pictures Auto Playback		P.20
6	Battery check	= full power, = low power	P.76
7	Shutter speed	15", 1/2, 1/60, 1/1000, etc.	P.17
8	Aperture value	F2.8 to F8.0	P.17
9	Exposure compensation	-2.0 - +2.0	P.22
10	White balance	WB AUTO,	P.39
11	Image size	etc.	P.34
12	File number	100-0004	P.54
13	Frame number	4	—
	Playing time/Total recording time	00:14/00:34	P.19
14	Current memory	: Playing back the picture in the internal memory No indication: Playing back the picture in the card	P.85
15	Image quality	RAW	P.34
	Compression	NORM (Normal), FINE (Fine)	P.34
	Frame rate	(15 frames/sec.), (30 frames/sec.)	P.35
16	ISO	ISO 100, ISO 800, ISO 1600 etc.	P.40
17	Date and time	2008.08.26 12:30	P.7, P.54

Button operations

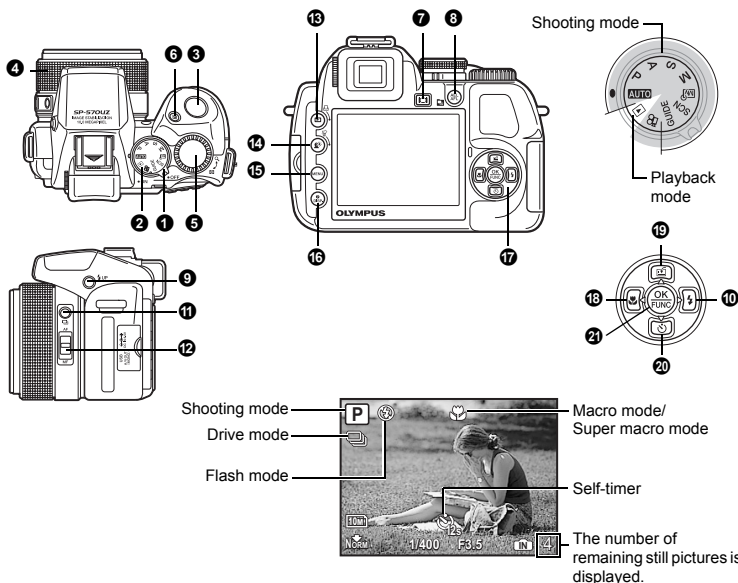

1 Power switch

Turning the camera on and off

Power on:

- Shooting mode
- Monitor turns on
 - Lens extends

- Playback mode
- Monitor turns on

2 Mode dial

Switching between shooting and playback modes

Set the mode dial to the desired shooting or playback mode.

- Some functions cannot be set depending on the position of the mode dial.

"Functions available in shooting modes" (P.79)

AUTO Shooting pictures with full automatic settings

The camera determines the optimum settings for the shooting conditions automatically. Settings in the [CAMERA MENU] such as WB and ISO sensitivity cannot be changed.

P Set the optimum aperture value and shutter speed

The camera automatically sets the optimum aperture value and shutter speed for the brightness of the subject.

Settings in the [CAMERA MENU] such as WB and ISO sensitivity can be changed.

A Changing the aperture value for shooting pictures



Adjustment range
W : F2.8 to F8.0
T : F4.5 to F8.0

Turn the control dial. The camera automatically sets the shutter speed.

Aperture value



: Turning toward **Q** increases the aperture value.

: Turning toward **☒** decreases the aperture value.

When the correct exposure cannot be obtained, the aperture value is displayed in red.

S Changing the shutter speed for shooting pictures



Adjustment range
1/2 to 1/1000
(When [NOISE REDUCT.] is set
to [ON]: up to 4 sec.)

Turn the control dial. The camera automatically sets the aperture value.

Shutter speed



: Turning toward **Q** sets the shutter speed faster.

: Turning toward **☒** sets the shutter speed slower.

When the correct exposure cannot be obtained, the shutter speed is displayed in red.

M Changing the aperture value and shutter speed for shooting pictures

Turn the control dial. Press **☒** to switch between the aperture value and the shutter speed.

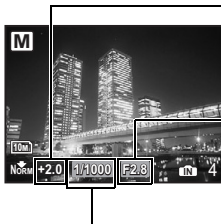

Adjustment range
Aperture value: F2.8 to F8.0
(The aperture value varies
depending on the zoom position.)
Shutter speed: 15" to 1/2000 (The
shutter speed varies depending
on the aperture value.)

Exposure differential

When this range has been exceeded $\pm 3.0\text{EV}$, the exposure differential is displayed in red.

Aperture value



: Turning toward **Q** increases the aperture value.

: Turning toward **☒** decreases the aperture value.

Shutter speed



: Turning toward **Q** sets the shutter speed faster.

: Turning toward **☒** sets the shutter speed slower.

To take long exposure (bulb) shots

Turn the control dial toward **☒** to set the shutter speed to BULB. The shutter remains open as long as the shutter button is pressed. (Bulb shooting is only possible when [ISO] is set to [64] (maximum time: 8 minutes).)

Shooting pictures with your own original modes

This mode allows you to set the shooting functions, save up to 4 shooting modes manually, and use them as your original shooting modes.

 "MY MODE SETUP Setting and saving shooting-related functions" (P.57)

Use the function menu or control panel to switch the registered My Mode.

 "My 1/2/3/4 Switching the registered original shooting mode" (P.28)
"Switching My Mode" (P.31)

SCN Shoot pictures by selecting a scene mode according to the situation

You can shoot pictures by selecting a scene mode according to the situation.

Select a scene mode/Change to another scene mode

- Press **MENU** and select [SCN] from the top menu.
- By switching to another scene mode, most settings will be changed to the default settings of the new scene mode.

 "**SCN** (Scene) Shooting pictures by selecting a scene according to the situation" (P.37)

GUIDE Follow the shooting guide to take better pictures

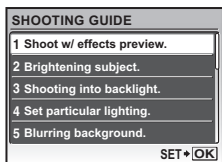

This function allows you to set the target items by following the shooting guide displayed on the screen.

- Press **MENU** to display the shooting guide again.
- To change the setting without using the shooting guide, select another shooting mode.
- Functions set using the shooting guide will revert to the default settings when **MENU** is pressed or when the shooting mode is changed.

Shooting pictures by comparing previews of different effects

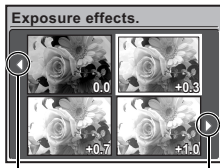

Select one of the [1 Shoot w/ effects preview.] options from the [SHOOTING GUIDE] menu to preview a live, multi-frame window on the monitor showing different levels of the selected shooting effect. You can use the four preview frames to compare the desired settings/effects.

- Use the arrow pad to select the frame with the desired settings, and press . The camera automatically switches to shooting mode and allows you to shoot with the selected effect.



Use   to change the display.

When [Exposure effects.] is selected

Recording movies

When  (movies) is set to [ON], audio is recorded with the movie.

- When recording with sound, only the digital zoom can be used. To use the optical zoom, set  (movies) to [OFF]. To zoom in when recording with sound, set [DIGITAL ZOOM] to [ON].

 " (movies) Recording sound with movies" (P.45)
"DIGITAL ZOOM Zooming in on your subject" (P.41)



This icon lights red during movie recording.

The remaining recording time is displayed.
When the remaining recording time reaches 0, recording will stop automatically.

- When [IMAGE STABILIZER] is set to [ON], continuous movie recording for a long period will cause the camera's internal temperature to rise and the camera may stop operation automatically. Remove the battery and allow the camera to cool down for some time before you begin shooting again. Or you can set [IMAGE STABILIZER] to [OFF]. In addition, the temperature of the camera's exterior also rises during usage. This is not a malfunction.

▶ Viewing pictures you have taken/Selecting playback mode

The last picture taken is displayed.

- Press the arrow pad to view other pictures.
 - Use the control dial to switch between close-up playback, index display and calendar display.
- ☞ "Control dial Index display/Calendar display/Close-up playback" (P.22)

▶ Playing back movies

Select a movie in the playback mode and press to play.



▶ Operations during movie playback



Playing time/Total recording time

△ : Increases the volume.

▽ : Reduces the volume.

▶ : Each time you press the button, the playback speed changes in the following order: 2x; 20x; and back to 1x.

◀ : Plays the movie in reverse. Each time you press the button, the playback speed changes in the following order: 1x; 2x; 20x; and back to 1x.

- Press to pause the playback.

Operations during pause



△ : Displays the first frame.

▽ : Displays the last frame.



▷ : Displays the next frame.

◁ : Displays the previous frame.

- To resume the movie, press .
- To cancel the playback of the movie in the middle of it or during pause, press **MENU**.

Viewing panoramic pictures taken with [COMBINE IN CAMERA 1] [COMBINE IN CAMERA 2] (Panorama playback)



- Use the arrow pad to select a panoramic picture, and then press . Scrolling from left to right or from bottom to top starts automatically.
 - Turn the control dial to zoom in or out while a picture is scrolling. Use the arrow pad to change the scrolling direction of a zoomed in picture.
 - To stop or resume scrolling in the original magnification, press .
 - To exit panorama playback, press **MENU**.
-  "PANORAMA Taking and combining panoramic pictures" (P.36)

Displaying pictures that have been shot continuously in index view (Sequential Playback) / Auto playing back of pictures that have been shot continuously (Sequential Pictures Auto Playback)





Only the first frame will be displayed for pictures that have been shot continuously using the following options.

 [Hi 1] [Hi 2] [AP] [BKT] [TIMELAPSE] [AUCTION] [SHOOT & SELECT 1] [SHOOT & SELECT 2] [SMILE SHOT]



AEL AFL/ 



- Select the pictures with  icon and press **AEL AFL/**  to play back in index view (Sequential Playback). Press **AEL AFL/**  again to return to the first frame.
- Select the pictures with  icon and press  to play back automatically (Sequential Pictures Auto Playback).
- This function is only available for pictures taken with this model.
- When the first frame is displayed, changes to any of the following functions will be applied to all the sequential pictures in the series:

On/  /PRINT ORDER/ERASE

To configure settings to individual pictures, press **AEL AFL/**  to display the pictures in index view first before configuring.

Shooting still pictures

Set the mode dial to **AUTO**, **P**, **A**, **S**, **M**, , **GUIDE** or **SCN**, and lightly press the shutter button (halfway). The AF target mark lights in green when the focus and exposure are locked (focus lock). The shutter speed and aperture value are displayed (only when the mode dial is set to **AUTO**, **P**, **A**, **S** or **M**). Now press the shutter button all the way (completely) to shoot a picture.



AF target mark

Locking the focus and then composing the shot (Focus lock)

Compose your picture with the focus locked, and then fully press the shutter button to shoot a picture.

- If the AF target mark blinks in red, the focus is not adjusted properly. Try locking the focus again.

Recording movies

Set the mode dial to , and press the shutter button halfway to lock the focus, and then press the shutter button completely to start recording. Press the shutter button again to stop recording.

4 Zoom ring

Zooming while shooting

Turn the zoom ring to zoom in on your subject when shooting.
Optical zoom ratio: 20×

Zoom in

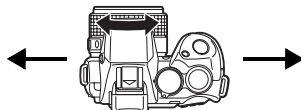

Zoom out

**Note**

- When the camera is mounted on a tripod, if the tripod pad is too big, it may obstruct rotation of the zoom ring.

5 Control dial

Index display/Calendar display/Close-up playback

Turn the control dial toward  or  to change the picture display in playback mode.

Single-frame playback

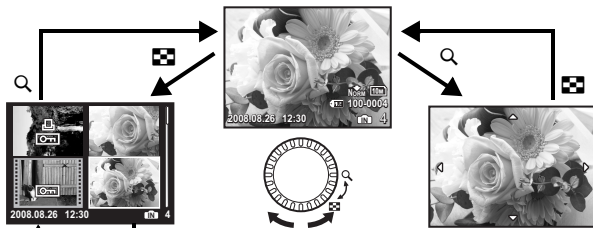

- Use the arrow pad to browse pictures.





Index display

- Use the arrow pad to select a picture for playback, and press  to playback the single-frame of the picture selected.

Close-up playback

- Turn the control dial toward  to incrementally enlarge the picture up to 10 times the original size. Turn the control dial toward  to reduce the size.
- Use the arrow pad during close-up playback to scroll around the picture.
- Press  to return to the single-frame playback.



Calendar display

- Use the arrow pad to select the date, and press  or turn the control dial toward  to display the pictures on the date selected.



6 button



Changing picture brightness (Exposure Compensation)



Press  in shooting mode and turn the control dial to adjust the brightness. Press  again to confirm your selection.

- Adjustable from - 2.0EV to +2.0 EV

 : Turn the control dial toward  to make the picture brighter.

 : Turn the control dial toward  to make the picture darker.

7 button

Monitor/Viewfinder

Toggles between the monitor and viewfinder.

8 AEL AFL/ button

Locking the focus position and exposure/Playing back continuously shot pictures in index display

AEL AFL Locking the focus position and exposure

Assign [AE LOCK], [AF LOCK] or [AF LOCK + AE LOCK] to **AEL AFL** so that the function concerned is enabled by pressing **AEL AFL** in shooting mode.

☞ "AEL/AFL BUTTON Registering the AE lock and AF lock functions" (P.57)

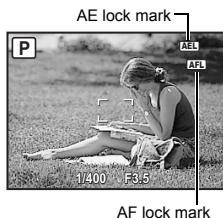

● Locking the focus position and exposure (AF lock + AE lock)

- Assign [AF LOCK + AE LOCK] to **AEL AFL**. The metering value is saved by pressing **AEL AFL** and the focus and exposure are locked. **AFL** (AF lock mark) and **AEL** (AE lock mark) are displayed on the monitor. Press **AEL AFL** again to cancel the AF lock + AE lock. Each time you press the button, the focus and exposure are locked and canceled alternately.

Playing back continuously shot pictures in index display

Only the first frame is displayed for pictures that have been shot continuously.

Press in the playback mode to display continuously shot pictures in index view.

☞ "Displaying pictures that have been shot continuously in index view (Sequential Playback) / Auto playing back of pictures that have been shot continuously (Sequential Pictures Auto Playback)" (P.20)

9 ⚡UP button

Flash pop-up

Opens the flash.

Press to take a picture with flash.

10 ⏪⚡ button

Flash shooting

Press in shooting mode to open the flash. Then press to select the flash setting.

Press to confirm your selection.

AUTO	Auto-flash	The flash fires automatically in low light or backlight conditions.
	Red-eye reduction flash	This emits pre-flashes to reduce the occurrence of red-eye in your pictures.
	Fill-in flash	The flash fires regardless of the available light.
	Red-eye fill-in flash	The flash always fires after pre-flashes for red-eye reduction are emitted.
	Flash off	The flash does not fire.
	Slow synchronization	The flash fires with slow shutter speed. The flash fires right after the shutter fully opens (1st curtain). As the flash fires with slow shutter speed, you can capture both the background, such as a night view, and the subject.
	Slow synchronization/ Red-eye reduction flash	While using slow synchronization (1st curtain) with flash shooting, you can also use this function to achieve red-eye reduction. Use this mode to take pictures of a person against a night view.

SLOW2	Slow synchronization 2	The flash fires just before the shutter closes (2nd curtain). You can use this setting to create interesting effects in your picture, such as expressing the movement of a car by showing the tail-lights streaming backwards. The slower the shutter speed, the more pronounced the effects.
--------------	------------------------	---

- Flash options are disabled if the pop-up flash is closed.

button

Single-frame shooting/Sequential shooting

Press in shooting mode to select the drive mode.

Press to confirm your selection.

	Single-frame shooting	Shoots 1 frame at a time when the shutter button is pressed.
	Sequential shooting	Focus and exposure are locked at the first frame. The sequential shooting speed varies depending on the image quality setting.
	High speed sequential shooting 1	Pictures can be taken at a faster speed than normal sequential shooting.
	High speed sequential shooting 2	Sequential shooting at a speed of approximately 13.5 frames/sec.
	Pre-capture	Sequential shooting at a speed of approximately 13.5 frames/sec. Pressing the shutter button halfway stores 10 frames of a picture immediately before shooting.
	AF sequential shooting	Adjusts the focus 1 frame at a time. The shooting speed is slower than for normal sequential shooting.

BKT	Bracket shooting	Takes pictures sequentially while changing the exposure for each frame. Focus and white balance are locked at the first frame.
------------	------------------	--

You can take a sequence of pictures at one time by holding down the shutter button. The camera will take pictures continuously until you release the shutter button.

- The exposure differential and number of frames for bracket shooting can be set in [DRIVE] in the [CAMERA MENU].

"DRIVE Continuous shooting" (P.40)

AF/MF switch

Changing the focus method

Slide the AF/MF switch in shooting mode to set the focus mode.

AF	Press the shutter button halfway. The camera automatically focuses.
MF	Adjust the focus manually.

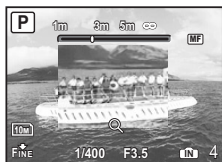



When set to [MF]

- Press to set the focus. During operation, the center of the frame is enlarged.
- Hold down to fix the focus. The focus is locked at the distance you have set, and MF is displayed in red on the monitor. To adjust the focus, hold down again.
- The distance displayed on the monitor is a reference figure.
- You can use the zoom ring or the control dial as well as to adjust the focus.

"MANUAL FOCUS Selecting the focusing method in manual focus mode" (P.58)

 Viewing pictures



Pictures you have taken are displayed on the monitor. Press  in shooting mode. Press  again or press the shutter button halfway to return to shooting mode.

 Printing pictures



When a printer is connected to the camera, display the picture you want to print in playback mode and press .

 "EASY PRINT" (P.59)

 Brightening the subject against backlight (Shadow Adjustment Technology)

Press  in shooting mode to turn on or off Shadow Adjustment Technology. Press  to confirm your selection. A frame is displayed on the monitor around your subject's face (except for ). This function makes the subject's face appear brighter, even against strong backlighting.

OFF	Shadow Adjustment Technology is deactivated.
ON	Shadow Adjustment Technology is activated.

- It may take a few seconds until the frame is displayed on the monitor.
- The faces may not be detected depending on the subject.
- When [ON] is selected, the following setting restrictions apply:
 - [METERING] is fixed at [ESP].
 - [AF MODE] is fixed at [FACE DETECT].
 - When [DRIVE] is set to any mode other than [, this function is only applied to the first frame.
 - [] automatically becomes [].

 Erasing pictures

In playback mode, select the picture you want to erase and press .

- Once erased, pictures cannot be restored. Check each picture before erasing to avoid accidentally erasing pictures you want to keep.

 "Protecting pictures" (P.50)

Displays the top menu.

DISP. Changing the information on display

Press **DISP.** to change the display in the following order.

Shooting mode

Playback mode

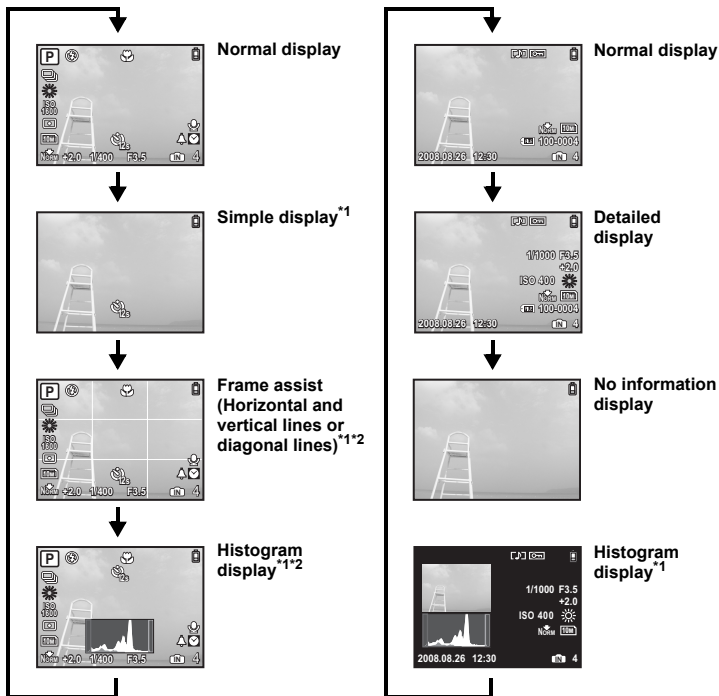

Button operations

*1 This is not displayed when the mode dial is set to or **GUIDE**.

*2 This is not displayed when the mode is set to [OFF] in the menu.

"Displaying the histogram" (P.57)

"FRAME ASSIST Displaying the frame assist/Determining the type of frame assist" (P.56)

? Displaying the menu guide

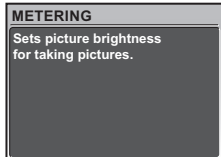

With a menu item highlighted, press and hold down **?** to display the menu guide.

Checking the time

While the camera is off, press **DISP./?** to display the set alarm time (when [ALARM CLOCK] is set) and the current time for 3 seconds.

17 Arrow pad (△▽◀▶)



Use the arrow pad to select scenes, playback picture, and the items on the menus.

18 button

Shooting pictures close to the subject (Macro mode)



Press  in shooting mode to select the macro mode.

Press  to confirm your selection.

OFF	Macro mode off	Macro mode is deactivated.
	Macro mode	This mode lets you shoot as close as 10 cm/3.9 in. (wide) from your subject.
	Super macro mode	This mode lets you shoot as close as 1 cm/0.4 in. from your subject.

19 button

Using this button as custom button

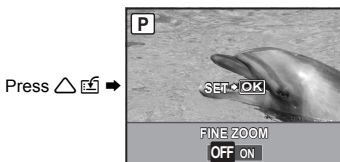

This allows you to register a frequently used function (except **AUTO**,  and **GUIDE**) to . Once registered, you can set the settings directly with the button instead of displaying the screen from the menu. The default setting is [OFF].

(Example) When [FINE ZOOM] is registered in [CUSTOM BUTTON]



A setting screen is displayed.

-  "CUSTOM BUTTON Assigning functions to the custom button" (P.58)
- "Functions that can be assigned to My Mode/custom button" (P.78)

Press  in shooting mode to select on or off for the self-timer.
Press  to confirm your selection.

OFF	Cancel the self-timer.
12s	After pressing the shutter button completely, the self-timer lamp lights for approximately 10 seconds, blinks for approximately 2 seconds, and then the picture is taken.
2s	After pressing the shutter button completely, the self-timer lamp blinks for approximately 2 seconds, and then the picture is taken.

- To cancel the self-timer, press .
- Self-timer shooting is automatically canceled after one shot.
- The self-timer cannot be used when [AF PREDICT] is [ON] or [PRE-CAPTURE] is [ON].

21  button (OK/FUNC)

Setting using the control panel or function menu

Press  in shooting mode to display the control panel or function menu. You can use the control panel to view the current settings and set the shooting mode functions. You can use the function menu to set frequently used functions in shooting mode.

This button is also used to confirm your selection.

- You can select whether to display the control panel or the function menu.

 "CONTROL PANEL Switching between the control panel and function menu" (P.53)



Setting using the control panel

 "Operations using the control panel" (P.29)

Setting using the function menu

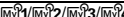

My 1/2/3/4 Switching the registered original shooting mode



- Displayed when the mode dial is set to .
- Settings are registered on  as a factory default.

Function menu



 : Select a setting and press .

 : Select the function to be set.

Other functions you can set with the function menu

 "WB Adjusting the color of a picture" (P.39)

"ISO Changing the ISO sensitivity" (P.40)

"METERING Changing the area for measuring the brightness of a subject" (P.41)

"IMAGE QUALITY Changing the image quality" (P.34)

Operations using the control panel

Pressing  in shooting mode displays a screen for setting and displaying shooting functions. This is called the control panel.

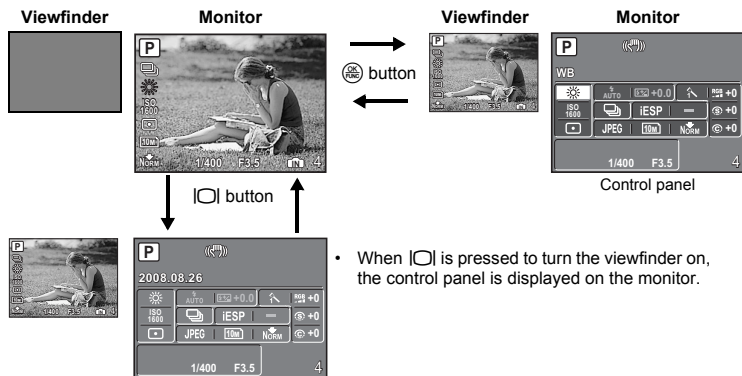
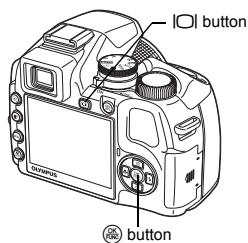

Control panel indications



- ① Displays the function settings status.
 - When or is pressed, the corresponding icon is selected and you can set the function.
 - "Setting using the buttons" (P.31)
- ② The battery check and flash charging marks are displayed.
- ③ The name of the function selected in area ④ is displayed. The name of the function is also displayed during custom button operations. When no function has been selected, the date is displayed.
- ④ You can set the following functions.
 - Use the arrow pad to select a function and use the control dial to change the settings.
 - "Using the control panel" (P.31)

Function	Ref. Page	Function	Ref. Page
WB	P.39	IMAGE QUALITY	P.34
FLASH MODE	P.23	IMAGE SIZE	P.34
	P.42	COMPRESSION	P.34
ISO	P.40	PICTURE MODE	P.43
DRIVE	P.40	SHARPNESS	P.44
AF MODE	P.41	CONTRAST	P.44
AREA	P.42	SATURATION	P.44
METERING	P.41		

- ⑤ The shutter speed, aperture value, exposure compensation value, exposure compensation indicator and flash intensity control indicator are displayed.
- ⑥ The number of storable still pictures/remaining recording time is displayed.

Using the control panel

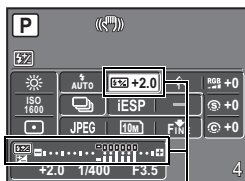

The flash intensity value and flash intensity control indicator are displayed.

(Example) To set [iESP]

- 1 Press to display the control panel on the monitor. The cursor lights in the function area.
- 2 Use the arrow pad to select [iESP] and then use the control dial to change the settings.
 - Items which cannot be selected are displayed in gray.
 - Items which cannot be set are indicated by [-].

Setting using the buttons



When is pressed

When , , , or is pressed, the corresponding icon on the control panel is selected. While its icon is selected, you can use the control dial to set the function's value.

Switching My Mode

Select this icon.

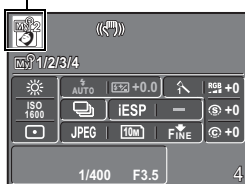

You can use this function when the mode dial is set to . Use the arrow pad to select and use the control dial to switch My Mode.

- "MY MODE SETUP Setting and saving shooting-related functions" (P.57)

Menu operations

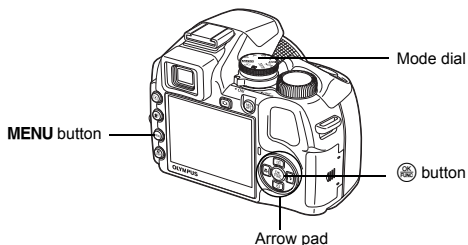

About the menus

- Pressing **MENU** displays the top menu on the monitor or viewfinder.
- The items displayed on the top menu differ according to the mode.

Top menu (When Mode Dial is set to **P**)

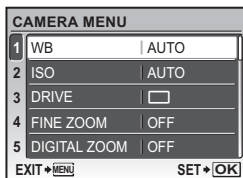
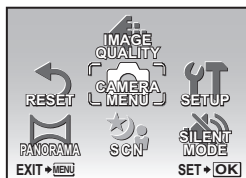

- When [CAMERA MENU], [PLAYBACK MENU], [EDIT], [ERASE] or [SETUP] is selected, the menu corresponding to the respective functions is displayed.
- When your camera is set according to the shooting guide with the mode dial set at **GUIDE**, press **MENU** to display the shooting guide screen.

Operation guide

During menu operations, the buttons and their respective functions are displayed at the bottom of the monitor. Follow these guides to navigate the menus.

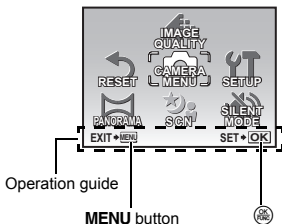

BACK→MENU : Returns to the previous menu.

EXIT→MENU : Exits the menu.

SET→OK : Sets the selected item.

Using the menus

This explains how to use the menus with [DIGITAL ZOOM] as an example.



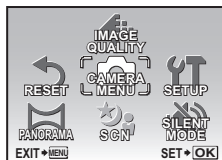

1 Set the mode dial to **P**.

2 Press **MENU** to display the top menu. Select [CAMERA MENU] and press .

- [DIGITAL ZOOM] is on a menu in [CAMERA MENU]. Press .



3 Press to select [DIGITAL ZOOM], and press .

- Unavailable settings cannot be selected.
- When pressing  on this screen, the cursor moves to the page display. Pressing   changes the page. To return to item selection, press  or .

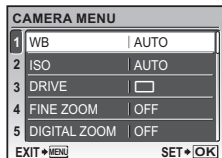

Page display: _____
The page display mark is displayed when there are additional menu items on the next page.

The selected item is displayed in a different color.

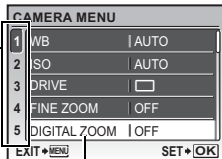



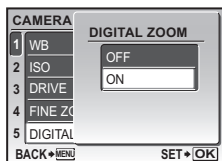

4 Press to select [OFF] or [ON], and press .

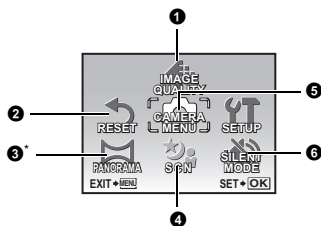
- The menu item is set and the previous menu is displayed. Press **MENU** repeatedly to exit the menu.
- To cancel changes and continue menu operation, press **MENU** before pressing .







CAMERA MENU

WB	 FLASH
ISO	 (still pictures)
DRIVE	[WBZ]
FINE ZOOM	PICTURE MODE
DIGITAL ZOOM	SHARPNESS
METERING	CONTRAST
AF MODE	SATURATION
FULLTIME AF	NOISE REDUCT.
AF PREDICT	TIMELAPSE
AF ILLUMINAT.	 (conversion lens)
IMAGE STABILIZER	 (movies)
[S2]	

* An OLYMPUS xD-Picture Card is required.

• Some menu items are not available depending on the position of the mode dial.

 "Functions available in shooting modes" (P.79)

 "SETUP menus" (P.52)

• The factory default settings are displayed in gray ().

1 IMAGE QUALITY

Changing the image quality

This function allows you to set [IMAGE QUALITY] (still pictures only) and [IMAGE SIZE] and [COMPRESSION] ([FRAME RATE] when recording movies).

• When [RAW] is selected in [IMAGE QUALITY], you cannot set [IMAGE SIZE] or [COMPRESSION].

Still picture image quality and their applications

IMAGE QUALITY

JPEG	Compressed still picture data in JPEG format. [IMAGE SIZE] and [COMPRESSION] can be set.
RAW* 3648 × 2736	Raw uncompressed data. Data is in ORF format.
RAW + JPEG*	Images are simultaneously recorded in JPEG and RAW formats at the time of shooting.

* Cannot be selected when set to **AUTO** or **SCN**.

IMAGE SIZE	Application
[10M] 3648 × 2736	Suitable for printing pictures over A3 (11 × 17 in.).
[5M] 2560 × 1920	Suitable for printing pictures at A4 (8.5 × 11 in.).
[3M] 2048 × 1536	Suitable for printing pictures up to A4 (8.5 × 11 in.).
[2M] 1600 × 1200	Suitable for printing pictures at A5 (5 × 7 in.).
[1M] 1280 × 960	Suitable for printing pictures at postcard size.
[VGA] 640 × 480	Suitable for viewing pictures on a TV or using pictures on emails and web sites.
[16:9] 1920 × 1080	Suitable for playing pictures on wide screen TV.

COMPRESSION

[FINE] FINE	Shooting at high quality.
[NORM] NORMAL	Shooting at normal quality.

Movie image quality

IMAGE SIZE

VGA 640 × 480

QVGA 320 × 240

FRAME RATE

30 30 frames/sec.

15 15 frames/sec.

 "Number of storable still pictures and recording length of movies" (P.72)











2 RESET

Change the shooting functions back to default settings

NO / YES

This function restores some shooting functions back to default settings.

Functions restored to the factory default settings

Function	Factory default setting	Ref. Page	Function	Factory default setting	Ref. Page
Flash	AUTO	P.23	FULLTIME AF	OFF	P.42
	OFF	P.27	AF PREDICT	OFF	P.42
	OFF	P.28	AF ILLUMINAT.	ON	P.42
Shadow Adjustment Technology	OFF	P.25	IMAGE STABILIZER	ON	P.42
	0.0	P.22		± 0.0	P.42
IMAGE QUALITY	JPEG	P.34	 FLASH	INT/EXT	P.43
IMAGE SIZE (still pictures/movies)	10M / QVGA	P.34	 (still pictures)	OFF	P.43
COMPRESSION	NORM	P.34	WB7	± 0	P.43
FRAME RATE	15	P.35	PICTURE MODE	NATURAL	P.43
WB	AUTO	P.39	SHARPNESS	± 0	P.44
ISO	AUTO	P.40	CONTRAST	± 0	P.44
DRIVE		P.40	SATURATION	± 0	P.44
FINE ZOOM	OFF	P.41	NOISE REDUCT.	ON	P.44
DIGITAL ZOOM	OFF	P.41	TIMELAPSE	OFF	P.45
METERING	ESP	P.41	 (conversion lens)	OFF	P.45
AF MODE	iESP	P.41	 (movies)	OFF	P.45
			Monitor/Viewfinder ()	Monitor	P.22
			SCN	PORTRAIT	P.37

COMBINE IN CAMERA1	As you recompose the frame, the camera automatically shoots and combines pictures in the camera.
COMBINE IN CAMERA2	Pictures are manually shot, and the camera automatically combines pictures in the camera.
COMBINE IN PC	Pictures are manually shot to be combined on a computer.

- An Olympus xD-Picture Card is required for shooting.
- When the card capacity is insufficient, this function cannot be selected.

[COMBINE IN CAMERA 1]

As you recompose the frame, the camera automatically shoots and combines pictures for a single panoramic picture in the camera. Only combined pictures are saved.

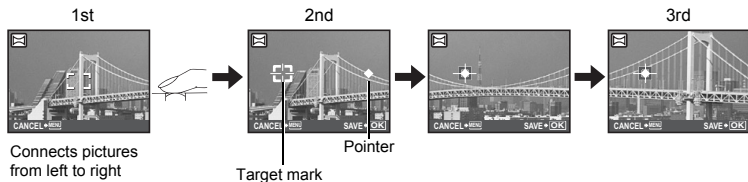

Connects pictures from left to right

- Take the first picture.
- When you slightly move the camera in the direction of the next picture, a target mark and a pointer appear.
- The pointer moves as you pan the camera. Move the camera slowly and steadily until the pointer overlaps the target mark, then stay still.
- The camera shoots the second picture automatically.
- After the current subject appears on the monitor, take the third picture in the same manner as the second one.
- After the third picture is taken, the pictures are automatically combined, and then the combined picture is displayed. To combine only two pictures, press before shooting the third picture.
- To cancel making the panoramic picture during shooting, press **MENU**.

[COMBINE IN CAMERA 2]

Pictures are manually shot, and the camera automatically combines pictures for a single panoramic picture in the camera. Only combined pictures are saved.

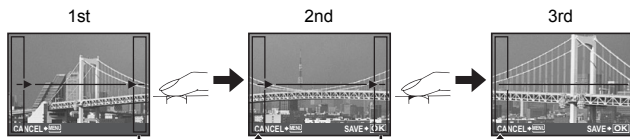

Connects pictures from left to right

- Use the arrow pad to specify at which edge you want to connect the pictures, and then take the first picture.
- Compose your second shot so that the edge of the first picture overlaps the edge of the second picture, then shoot.
- Take the third picture in the same manner as the second one.
- After the third picture is taken, the pictures are automatically combined, and then the combined picture is displayed. To combine only two pictures, press before shooting the third picture.
- To cancel making the panoramic picture during shooting, press **MENU**.

[COMBINE IN PC]

Create a panoramic picture using the OLYMPUS Master software from the provided CD-ROM.

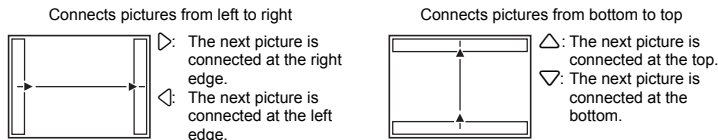

Use the arrow pad to specify at which edge you want to connect the pictures, and then compose your shots so that the edges of the pictures overlap.

Shooting is possible for up to 10 pictures. Press to exit panorama shooting.

- In [COMBINE IN PC] the previous picture for positioning does not remain. Remember the frame displayed on the monitor as a rough indication, then compose the shot so that the edges of the previous picture in the frame overlap with the next shot.

! Note

- Focus, exposure, WB and zoom are locked in the first frame, and the flash does not fire.
- In [COMBINE IN CAMERA1] or [COMBINE IN CAMERA2] mode, image quality is locked.
- Optical zoom magnification is restricted to 10x.
- In [COMBINE IN CAMERA1] mode, camera settings are automatically optimized for this mode. In [COMBINE IN CAMERA2] or [COMBINE IN PC] mode, pictures are taken in the last [ISO] or [SCN] settings set (except for some scene modes).
- In panorama mode, Shadow Adjustment Technology is not available.
- Pictures taken in panorama mode cannot be edited, except for [LIGHTING FIX] in [PERFECT FIX].

4 SCN (Scene)

Shooting pictures by selecting a scene according to the situation

PORTRAIT /LANDSCAPE/LANDSCAPE+PORTRAIT/SPORT/
NIGHT SCENE^{*1}/NIGHT+PORTRAIT^{*1}/INDOOR/CANDLE/SELF PORTRAIT/
AVAILABLE LIGHT/SUNSET/FIREWORKS^{*1}/MULTI FIREWORKS/CUISINE/
BEHIND GLASS/DOCUMENTS/AUCTION^{*2}/SHOOT & SELECT1^{*2}/
SHOOT & SELECT2^{*3}/SMILE SHOT/BEACH/SNOW/QUICK SHUTTER

The scene mode selection screen displays sample images as well as a description of the shooting situation for which the selected scene is designed. It can be set only when the mode dial is set to **SCN**.

"Mode dial Switching between shooting and playback modes" (P.16)

- By switching to another scene mode, most settings will be changed to the default settings of the new scene mode. The zoom position may change automatically depending on the scene.
- *1 When the subject is dark, noise reduction is automatically activated. This approximately doubles the shooting time, during which the next picture cannot be taken.
- *2 The focus is locked at the first frame.
- *3 During sequential shooting, the camera focuses for each frame.

Scene mode selection screen



Set the scene mode.

[MULTI FIREWORKS]

- This function allows you to take multiple exposures of two images on a single frame.
- Take the first image. The first image is saved and then displayed in the background. Compose the shot and take the second image. The second image is saved and the two images are combined and saved as a separate file. The combined picture is displayed during saving, and then the camera is again ready to take a second image. You can continue to take multiple exposure pictures.
- The exposure is locked at the first image.

When taking the first image

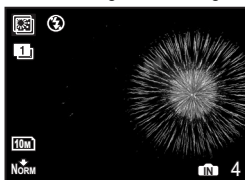

When taking the second image

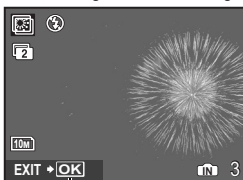

Press to return to taking the first image.

[SHOOT & SELECT1] [SHOOT & SELECT2]

- Press and hold the shutter button to shoot sequential pictures. After shooting pictures, select the ones you want to erase by marking them with and press to erase them.

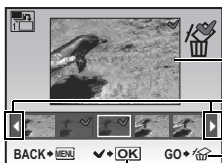

Selected picture.

Press to scroll through the pictures.

Pictures with are erased.

Select the pictures to be erased.

Press to add or erase to a picture to be deleted.

[SMILE SHOT]







- When the camera detects a smiling face in shooting standby mode, 3 frames are automatically taken in high speed sequential shooting mode. You can also shoot a picture by pressing the shutter button.
- A smiling face may not be detected for some subjects.
- When [SMILE SHOT] is selected, the self-timer lamp lights. Shooting is not available while the self-timer lamp is blinking.

[QUICK SHUTTER]

- The shutter release time lag is shorter than normal. This enables you not to miss a single photo opportunity.
- [FULLTIME AF] is automatically set to [ON].
- "FULLTIME AF Shooting pictures while keeping the subject in focus" (P.42)
- and in [DRIVE] can be set.

5 CAMERA MENU

WB Adjusting the color of a picture

AUTO		The white balance is adjusted automatically for natural color, regardless of the light source.
PRESET		Selects the white balance according to the light source.
	Sunny day	For shooting under a clear sky.
	Cloudy day	For shooting under a cloudy sky.
	Tungsten light	For shooting under tungsten lighting.
	Fluorescent lamp 1	For shooting under daylight fluorescent lighting. (This type of lamp is mainly used in homes.)
	Fluorescent lamp 2	For shooting under a neutral white fluorescent lamp. (This type of lamp is mainly used in desk lamps.)
	Fluorescent lamp 3	For shooting under a white fluorescent lamp. (This type of lamp is mainly used in offices.)
	One-touch WB	For setting a more precise white balance than preset white balance can provide. You can set and save the optimum white balance for the shooting conditions.

When [PRESET] is selected

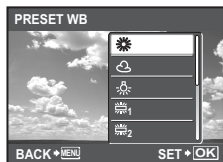

Press \triangle / ∇ to select a white balance setting, then press OK .

When [ONE TOUCH WB] is selected

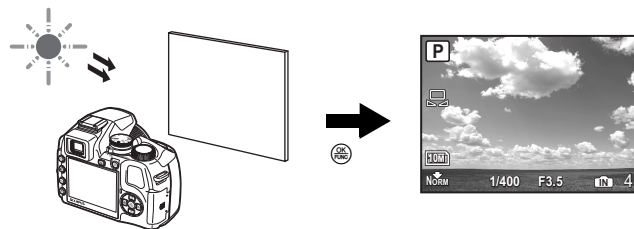





- With the [ONE TOUCH WB] screen displayed, point the camera at a sheet of white paper. Position the paper so that it fills the screen, making sure there are no shadows.
- Press WB . The new white balance is set.

ISO Changing the ISO sensitivity

AUTO	Sensitivity is automatically adjusted according to the conditions of the subject.
HIGH ISO AUTO	This function has a higher sensitivity compared to [AUTO] and stabilizes the blur caused by a moving subject or camera movement when taking pictures.
64/100/200/400/ 800/1600/3200/ 6400	A low value reduces the sensitivity for daylight shooting of sharp, clear pictures. The higher the value, the greater the camera's light sensitivity and ability to shoot with a fast shutter speed and in low light conditions. However, high sensitivity introduces noise into the resulting picture, which may give it a grainy appearance.

- If set to [6400], [IMAGE SIZE] is limited to [5M] and lower.
- If [FINE ZOOM] or [DIGITAL ZOOM] is set to [ON], [6400] cannot be set.

DRIVE Continuous shooting

	Shoots 1 frame at a time when the shutter button is pressed.	
	Focus and exposure are locked at the first frame. The sequential shooting speed varies depending on the setting of image quality.	
	Pictures can be taken at a faster speed than normal sequential shooting.	
	Sequential shooting at a speed of approximately 13.5 frames/sec. <ul style="list-style-type: none"> • [PRE-CAPTURE] can be set. When set to [ON], pressing the shutter button halfway stores 10 frames of a picture immediately before shooting. 	
	PRE-CAPTURE	OFF / ON
	Adjusts the focus 1 frame at a time. The shooting speed is slower than for normal sequential shooting.	
BKT	Takes pictures sequentially while changing the exposure for each frame (Bracket shooting). Focus and white balance are locked at the first frame. <ul style="list-style-type: none"> • When [BKT] is selected, the exposure differential and number of frames can be set. 	
	Exposure differential	± 0.3 / ± 0.7 / ± 1.0
	Number of frames	×3 / ×5

You can take a sequence of pictures at one time by holding down the shutter button. The camera will take pictures continuously until you release the shutter button.

- Only [] is available when [IMAGE QUALITY] is set to [RAW] or [RAW+JPEG].
- When [Hi 1] or [Hi 2] is selected, other functions are restricted as follows.
 - The flash mode is fixed at [].
 - When [Hi 1] is selected, [IMAGE SIZE] is limited to [5M] and lower and the number of pictures that can be taken continuously to approximately 30 or less (or approximately 20 or less when [5M] and [FINE] are selected). When [Hi 2] is selected, [IMAGE SIZE] is limited to [3M] and lower and the number of pictures that can be taken continuously to approximately 30 or less (including the 10 pictures when [PRE-CAPTURE] is set to [ON]).
 - [ISO] settings will be restricted.

FINE ZOOM Zooming in on your subject without reducing image quality

OFF /ON

This function allows you to zoom up to 30× by combining the optical zoom and image cropping. As data with few pixels are not converted to multiple pixels, there is no loss of image quality.

- [IMAGE SIZE] is limited to [3M] and lower.
- [FINE ZOOM] cannot be used in combination with [DIGITAL ZOOM].

DIGITAL ZOOM Zooming in on your subject

OFF /ON

The digital zoom can be used to take close-up pictures with stronger magnification than the optical zoom.

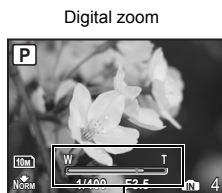
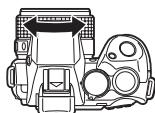
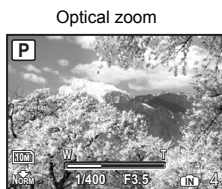

Maximum magnification:
Still picture shooting modes
Optical zoom × digital zoom: Approx. 100× (max.)
Movie shooting mode
Optical zoom × digital zoom: Approx. 60× (max.)

Zoom bar
White: The optical zoom area
Yellow: The digital zoom area

METERING Changing the area for measuring the brightness of a subject



ESP	Meters the brightness at the center of the monitor and the surrounding area separately to capture an image with balanced brightness. When taking pictures against strong backlight, the center of the picture may appear dark.
	The AF target mark area is metered. Recommended for taking a picture against strong backlight.
	Meters the brightness over a wide area with emphasis on the center of the screen. This method is used when you do not want to allow surrounding light to affect the picture.

AF MODE Changing the focusing area

FACE DETECT	When a face is being detected in the screen, the camera will focus on the face. A frame is displayed at the detected position.
iESP	The camera determines which subject within the screen to focus on. Even when the subject is not in the center of the screen, focusing is possible.
SPOT	Focus selection is based on the subject within the AF target mark.
AREA	Move the AF target mark to select the area you want to focus on to take a picture.

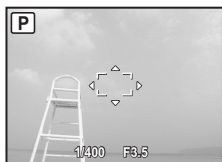
- The [FACE DETECT] may not be able to detect the face for some subjects.
- If [FINE ZOOM] or [DIGITAL ZOOM] is set to [ON], [AREA] cannot be set.

When [AREA] is selected

- To move the AF target mark
The AF target mark changes to . Use the arrow pad to move the position of the AF target mark.
You can take pictures while in this status.
- To set the position of the AF target mark
Hold down .
To change the position of the mark, hold down  again.

FULLTIME AF Shooting pictures while keeping the subject in focus

OFF	Press the shutter button halfway to focus.
ON	Fulltime AF keeps the subject in front of the lens in focus at all times, without having to press the shutter button halfway. The focusing time is reduced, so you will not miss snapshot opportunities. Also, the subject is automatically kept in focus during movie recording.

AF PREDICT Shooting pictures with the focus on subjects moving back and forth

OFF	AF predict is deactivated.
ON	When activated, position the AF target mark on the subject and press the shutter button halfway to engage the AF predict. Then, press the shutter button completely to take the picture.

- AF predict continues to operate while the shutter button is pressed halfway ( blinks).
- Depending on the subject, the picture may be out of focus even if [AF PREDICT] is set.
- During macro and super macro mode, [AF PREDICT] is not available.

AF ILLUMINAT. Setting to light the illuminator in a dark place

OFF	AF illuminator does not light.
ON	Press the shutter button halfway. The AF illuminator lights automatically, allowing you to focus in a dark place.

IMAGE STABILIZER Shooting pictures using dual image stabilization

This function stabilizes the blur caused by camera movement when taking pictures.



OFF	Dual image stabilization is deactivated.
ON	Dual image stabilization is activated after pressing the shutter button halfway.

- When taking pictures with the camera stabilized (using a tripod), set to [OFF].
- Images may not be correctable if the camera is severely shaken.
- During night shooting or when the shutter speed is very slow, the Digital image stabilization mode may not work.

 Adjusting the amount of light emitted by the flash

Depending on situations such as shooting small subjects or distant backgrounds, it may be advisable to adjust the amount of light emitted by the flash. In addition, this function is useful when increased contrast is desired.

-2.0EV to	0.0	to +2.0EV
-----------	-----	-----------

Press   to adjust, and press .

FLASH Setting to use an external flash

INT/EXT	Allows you to take pictures using the built-in flash or a dedicated external flash. ☞ "External flash shooting" (P.82)
⚡ RC	Allows you to take pictures using a flash that is compatible with the Olympus wireless RC flash system. ☞ "Shooting with the Olympus wireless RC flash system" (P.84)
SLAVE	When using a commercially available slave flash that is synchronized with the camera flash, the amount of the light emitted by the flash can be adjusted in 10 levels.

Selecting an emission level

- When flash is set to [SLAVE], flash mode automatically changes to [⚡] (Fill-in flash) for all flash modes except [☞] (Flash off).

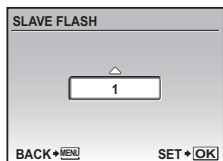

Press Δ / ∇ to select an emission level from [1] to [10], then press \odot . The bigger number indicates the bigger amount of light emitted by the flash.

- The flash can fire in sequential shooting mode, but the interval between shots will be longer if a high emission level is set.

☎ (still pictures) Recording sound with still pictures

OFF / ON

It automatically starts recording for about 4 seconds after shooting pictures.

When recording, aim the camera microphone at the source of the sound you want to record.

WB Adjusting the white balance compensation



- The white balance can be adjusted in 7 increments in both the [BLUE] and [RED] directions.

Δ : Each press makes the color more blue.
 ∇ : Each press makes the color more red.

Press \odot after setting is complete.

PICTURE MODE Adjusting the color tone of the image

VIVID	Produces vivid colors.
NATURAL	Produces natural colors.

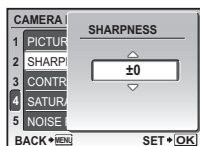
SHARPNESS Adjusting the sharpness of the image

△ (Toward +)

: The image contours are emphasized, making the image appear sharper. If you adjust the sharpness too far toward +, noise may become conspicuous in the picture.

▽ (Toward -)

: The image contours are softened.

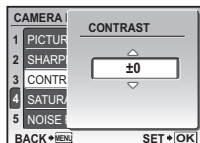
CONTRAST Adjusting the contrast of the image

△ (Toward +)

: The light and dark areas are defined more clearly, making the image look crisper.

▽ (Toward -)

: The light and dark areas become less defined, giving the image a softer impression.

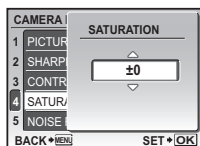
SATURATION Adjusting the saturation of the image

△ (Toward +)

: Colors become stronger.

▽ (Toward -)

: Colors become weaker.

NOISE REDUCT. Reducing the noise during long exposures

OFF	Noise is not reduced. Noise may be conspicuous at slow shutter speeds.
ON	Noise is reduced. Shooting time takes twice as long as usual. Shooting is not available during noise reduction. Noise reduction can only be used when the shutter speed is slower than 1/2 sec.

- This function may not work effectively with some shooting conditions or subjects.

TIMELAPSE Shooting pictures automatically as defined by set conditions

OFF	Timelapse shooting is deactivated.
ON	Timelapse shooting is activated.

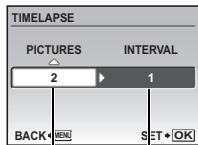

Number of shots: 2 to 99
Shooting interval: 1 to 99 minutes in 1 minute intervals

When setting the timelapse shooting

- Press \triangleleft / \triangleright to select [PICTURES] and [INTERVAL].
 - Press \triangle / ∇ to set the value.
 - Press \odot to set.
 - The first picture is taken when the shutter button is pressed, and the pictures thereafter are automatically taken.
 - During timelapse, the \odot mark lights on the monitor.
 - When recording to either the internal memory or the card, and after the first picture is taken, the camera enters sleep mode. The camera automatically reactivates from sleep mode 4 seconds prior to taking the next picture.
 - When the preset number of pictures is taken, the camera automatically turns off.
- If you will be taking pictures over a long period, make sure to use fully charged batteries or the AC adapter.
 - If any of the following operations occur during sleep mode, the camera cancels the timelapse mode and returns to normal shooting.
Opening the battery compartment cover, opening the card cover, connecting the camera to a computer, operating the shutter button, arrow pad or other button.
 - If the internal memory/card becomes full or the battery power runs out during timelapse shooting, a warning is displayed, timelapse stops and the camera automatically turns off.

..... Shooting pictures with conversion lens

OFF /ON

Set this function when shooting with the camera using a conversion lens (option) specified by Olympus.

- Using the built-in flash with the conversion lens attached can cause vignetting. Use an external flash if required.
- When the conversion lens is attached, the camera may take some time to focus.

..... Recording sound with movies

OFF /ON

- If the camera is more than 1 m (3.3 ft.) away from the source of the sound, sound may not be recorded clearly.
- When \odot (movies) is set to [ON], [IMAGE STABILIZER] is not available.
- If [FULLTIME AF] and \odot (movies) are both set to [ON], the sound of operating lens may be recorded.

6 SILENT MODE

Setting to turn off operational sounds

OFF /ON

This function allows you to turn off operational sounds that occur during shooting and playback, warning beeps, shutter sounds, etc.



4 EDIT

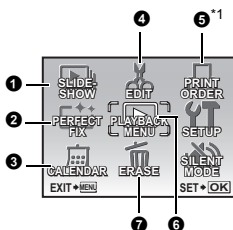
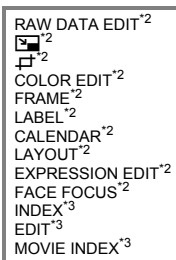

6 PLAYBACK MENU



- *1 A card is required.
- *2 This is not displayed when a movie is selected.
- *3 This is not displayed when the still picture is selected.

"SETUP menus" (P.52)

"SILENT MODE Setting to turn off operational sounds" (P.45)

- The factory default settings are displayed in gray ().

1 SLIDESHOW

Playing back pictures automatically

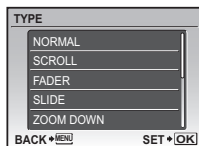

- Select the transition effect between pictures from [TYPE] and press . The [BGM] selection screen is displayed. After selecting the [BGM], press to start the slideshow.

TYPE	NORMAL /SCROLL/FADER/ SLIDE/ZOOM DOWN/ZOOM UP/ CHECKERBOARD/BLINDS/SWIVEL/RANDOM
BGM	OFF / 1 / 2

- Only the first frame of each movie is displayed.
- Press or **MENU** to cancel the slideshow.

2 PERFECT FIX

This function allows you to correct the taken picture and save it as a new picture.

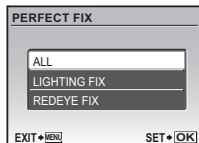

- Select the item to be corrected with and press .
- Select the picture with and press .

ALL	Lighting fix and red-eye fix are activated together.
LIGHTING FIX	Only the dark areas of an image are corrected. Underexposed areas caused by taking pictures against backlight or insufficient lighting are brightened.
REDEYE FIX	Only red-eye fix is activated.

- When red eye is not detected with [REDEYE FIX], press to cancel the correction.
- Movies, pictures shot by another camera, and previously fixed or edited pictures cannot be corrected.
- Some pictures may not be corrected completely.
- Editing an image may cause it to suffer a minor loss in quality.

3 CALENDAR

Playing back the pictures in a calendar format

This function lets you playback the pictures in a calendar format, organized by the date the images were recorded.

4 EDIT

RAW DATA EDIT Editing the pictures recorded in raw data format

Adjusts the pictures recorded in raw data format and stores them as new pictures in JPEG format.

Items that can be set with [RAW DATA EDIT]

Item	Settings	Ref. Page
IMAGE QUALITY	IMAGE SIZE : 10M / 5M / 3M / 2M / 1M / VGA / 16:9 COMPRESSION : FINE / NORM	P.34
WB	AUTO/PRESET / 	P.39
[WB%]	RED7 - BLUE7	P.43
PICTURE MODE	VIVID/NATURAL	P.43
SHARPNESS	-5 - +5	P.44
CONTRAST	-5 - +5	P.44
SATURATION	-5 - +5	P.44

* Available only when the picture is taken with [WB] set to .

..... Changing the size of pictures



VGA 640 × 480 **[QVGA]** 320 × 240

This changes the image size of a picture and saves it as a new file.

..... Cropping a part of pictures

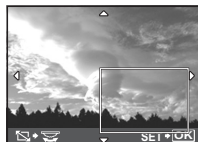
Designates and crops part of a still picture and saves it as a new file.





- Press \triangleleft / \triangleright to select the image to crop, and press .
- Use the arrow pad and the control dial to adjust the position and size of the picture, and press .

COLOR EDIT Changing the color of a picture

This function lets you change the color of a picture and save it as a new picture.



- Select the picture with \triangleleft / \triangleright and press .
- Select your desired color with the arrow pad, and press .

① BLACK & WHITE	This changes the picture to black and white.
② SEPIA	This changes the pictures to sepia.
③ SATURATION (HARD)	This enhances the saturation of the picture.
④ SATURATION (SOFT)	This slightly enhances the saturation of the picture.

FRAME **Add a frame to your picture**

This function lets you select a frame, integrate the frame with an image, and save it as a new picture.



- Select the picture to be framed with $\triangleleft \triangleright$, and press OK . (Press $\triangle \nabla$ to turn the picture 90 degrees clockwise or 90 degrees counterclockwise.)
- Select a frame with $\triangleleft \triangleright$ and press OK .
- Use the arrow pad and the control dial to adjust the position and size of the picture, and press OK .

LABEL **Add a label to your picture**

This function lets you select a label, integrate the label with an image, and save it as a new picture.



- Select the picture with $\triangleleft \triangleright$ and press OK .
- Select the label with $\triangleleft \triangleright$, and press OK . (Press $\triangle \nabla$ to rotate the picture 90° clockwise or counterclockwise.)
- Use the arrow pad and the control dial to adjust the position and size of the label, and press OK .
- Set the color of the label with the arrow pad, and press OK .

CALENDAR **Create a calendar print with your picture**

This function lets you select a calendar format, integrate the calendar with a picture, and save it as a new file.

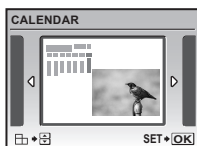

- Select the picture with $\triangleleft \triangleright$ and press OK .
- Select the calendar with $\triangleleft \triangleright$, and press OK . (Press $\triangle \nabla$ to rotate the picture 90° clockwise or counterclockwise.)
- Set the date of the calendar, and press OK .

LAYOUT **Creating an index layout of pictures**

ALL IMAGES	All pictures in the internal memory or the card are added to the layout.
CALENDAR	A monthly calendar appears and the pictures you want to make layout are selected by the date.
SEL. IMAGE	Pictures that you want to make layout are specified one by one.

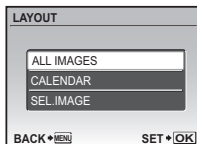

- Press $\triangleleft \triangleright$ to select a layout, and press OK .
- Select the type of layout picture, and press OK .
- Select the pictures and press OK . (When [SEL. IMAGE] is selected in [LAYOUT] screen, press $\triangle \nabla$ to rotate the picture 90° clockwise or counterclockwise.)

EXPRESSION EDIT Transforming a face in the picture

This function lets you transform a face that is largest and facing front in the picture, and save it as a new picture.

- Select the picture with $\triangleleft \triangleright$ and press MENU .
- Use the arrow pad to select the desired effect, and press MENU .
- The face may not be detected correctly for some subjects.

FACE FOCUS Showing up a face in the picture

This function lets you change the largest face that is facing the front and save it as a new picture.

- Select the picture with $\triangleleft \triangleright$ and press MENU .
- The face may not be detected correctly for some subjects.

INDEX Making an index picture from a movie

This function extracts 9 frames from a movie and saves them as a new picture containing thumbnails of each frame.



- Use $\triangleleft \triangleright$ to select a movie and press MENU .
- Use the arrow pad to select the first frame of the part you want to keep, and press MENU . In the same manner, select the last frame of the part you want to keep and press MENU .

EDIT Extracting a part of the movie

Allows you to specify a part of the movie and overwrite it, or save it as a new movie.



- Select [NEW FILE] or [OVERWRITE], and press MENU .
- Use the arrow pad to select the first frame of the part you want to keep, and press MENU . In the same manner, select the last frame of the part you want to keep and press MENU .

MOVIE INDEX Capturing a still image from the movie

Allows you to capture a frame from the movie and save it as a still image in JPEG format.



- Use $\triangleleft \triangleright$ to select a movie and press MENU .
- Use the arrow pad to select the frame to capture, and press MENU .

5 PRINT ORDER**Making print reservations (DPOF)**

This function allows you to save printing data (the number of prints and the date and time information) with the pictures stored on the card.

- MENU "Print settings (DPOF)" (P.61)

6 PLAYBACK MENU

Key Protecting pictures

OFF / ON



Protected pictures cannot be erased with [ERASE]/[SEL. IMAGE]/[ALL ERASE], but they are all erased by formatting.

- Select the picture with \triangleleft / \triangleright , and protect it by selecting [ON] with \triangle / ∇ . You can protect several frames in succession. When a picture is protected, \square is displayed on the monitor.

Key Rotating pictures

\square +90° / \blacksquare 0° / \square -90°

Pictures taken with the camera held vertically are displayed horizontally during playback. This function allows you to turn such pictures so that they are displayed vertically. New picture orientations are saved even when the power is turned off.

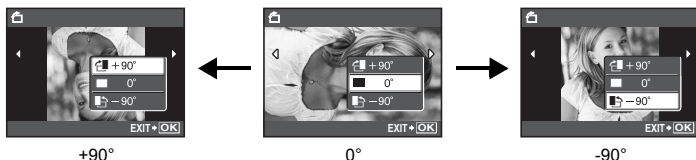

Select the picture with \triangleleft / \triangleright , and rotate it by selecting [\square +90°], [\blacksquare 0°] or [\square -90°] with \triangle / ∇ . You can rotate several frames in succession.

Key Adding sound to still pictures

YES / NO



Sound is recorded for about 4 seconds.

- Use \triangleleft / \triangleright to select a picture, select [YES] and press RECORD to start recording.
- The [BUSY] bar will be temporarily displayed.

INDEX PLAY Selecting the playback position of the movie



Movies are played from the specified position.

- Use the arrow pad to select a frame. Press RECORD to start playback from the selected frame.
- Use the control dial to change the number of displayed index frames.

Protected pictures cannot be erased. Cancel protection before erasing protected pictures. Once erased, pictures cannot be restored. Check each picture before erasing to avoid accidentally erasing pictures you want to keep.

- When erasing the picture in the internal memory, do not insert the card into the camera.
- When erasing the picture from the card, insert a card into the camera in advance.
- You can confirm on the monitor whether the internal memory or card is being used.

"Using the internal memory or card" (P.85)

SEL. IMAGE Selecting images to erase



- Use the arrow pad to select a picture, and press to add .
- Press again to cancel the selection.
- When the selection is completed, press .
- Select [YES], and press .

ALL ERASE Erase all the pictures in the internal memory or the card

- Select [YES], and press .

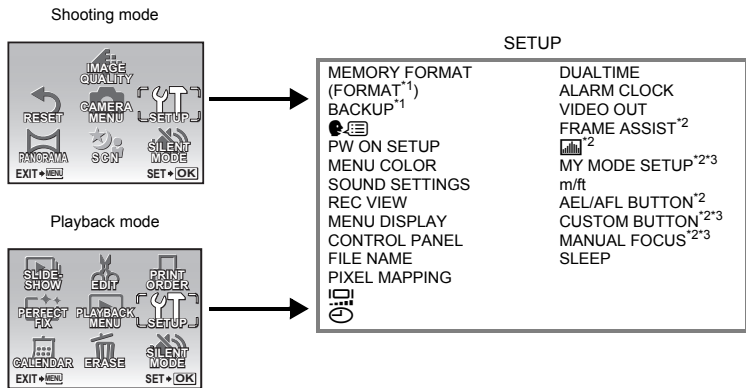

- *1 A card is required.
- *2 Not available when the mode dial is set to .
- *3 Not available when the mode dial is set to **AUTO**.

MEMORY FORMAT (FORMAT) Formatting the internal memory or card

All existing data, including protected pictures, are erased when the internal memory or card is formatted. Make sure that you save or transfer important data to a computer before formatting.

- Make sure there is no card inserted in the camera when formatting the internal memory.
- Be sure that the card is inserted in the camera when formatting the card.
- Before using non-Olympus cards or cards which have been formatted on a computer, you must format them with this camera.

BACKUP Copying pictures in the internal memory to the card

Insert the optional card into the camera. Copying data does not erase the picture in the internal memory.

- It takes some time to back up data. Check if the battery is not empty before starting the copy, or use the AC adapter.

..... Selecting a display language

You can select a language for on-screen display. Available languages vary depending on the area where you purchased this camera.

PW ON SETUP Setting the startup screen and sound

SCREEN	OFF (No picture is displayed.)	/	1	/	2
VOLUME	OFF (No sound)	/	LOW	/	HIGH

- Select [2] and press to set the still picture saved in the internal memory or card as the startup screen.
- When [SCREEN] is set to [OFF], [VOLUME] cannot be set.

MENU COLOR Setting the menu screen color

NORMAL	/	COLOR1	/	COLOR2	/	COLOR3
--------	---	--------	---	--------	---	--------

SOUND SETTINGS Setting the sounds output from the camera

You can make the following settings with [SOUND SETTINGS].

- Setting the type of button operation sounds and volume. (BEEP)
- Selecting the sound and volume of the shutter button. (SHUTTER SOUND)
- Adjusting the volume of the camera warning sound. (■))
- Adjusting the volume during playback. (▶) VOLUME)

BEEP	SOUND TYPE	1 / 2
	VOLUME	OFF (No sound) / LOW / HIGH
SHUTTER SOUND	SOUND TYPE	1 / 2 / 3
	VOLUME	OFF (No sound) / LOW / HIGH
■))		OFF (No sound) / LOW / HIGH
▶) VOLUME		<ul style="list-style-type: none"> • Press \triangle ∇ on the arrow pad to adjust the volume. • You can select [OFF] or adjust in 5 steps from 1 to 5.

- You can set all the sounds muted at once by setting [SILENT MODE].



 "SILENT MODE Setting to turn off operational sounds" (P. 45)

REC VIEW Viewing pictures immediately

OFF	The picture being recorded is not displayed. This is useful when you want to prepare for your next shot while the previous picture is being recorded.				
ON	<p>The picture being recorded is displayed. This is useful when you want to quickly review the last picture taken. You can resume shooting while the picture is still being displayed.</p> <ul style="list-style-type: none"> • Select [ON] to set whether to display the image on the monitor or viewfinder during recording. 				
	<table border="1"> <tbody> <tr> <td>LCD ONLY</td> <td>Pictures that are being recorded will always be displayed on the monitor.</td> </tr> <tr> <td>CURRENT</td> <td>Pictures that are being recorded will be displayed on the viewfinder when the viewfinder is used and on the monitor when the monitor is used.</td> </tr> </tbody> </table>	LCD ONLY	Pictures that are being recorded will always be displayed on the monitor.	CURRENT	Pictures that are being recorded will be displayed on the viewfinder when the viewfinder is used and on the monitor when the monitor is used.
LCD ONLY	Pictures that are being recorded will always be displayed on the monitor.				
CURRENT	Pictures that are being recorded will be displayed on the viewfinder when the viewfinder is used and on the monitor when the monitor is used.				

MENU DISPLAY Displaying menu display on the monitor

Perform next operation to set whether to display on the monitor or viewfinder.

- When **MENU** is pressed
- When  is pressed in the playback mode
- When  is pressed in the shooting mode

LCD ONLY	This always displays the menu on the monitor.
CURRENT	This displays the menu on the viewfinder when the viewfinder is used and on the monitor when the monitor is used.

CONTROL PANEL Switching between the control panel and function menu

OFF	The function menu is displayed on the monitor or in the viewfinder.
ON	The control panel is displayed on the monitor.

-  "OK/FUNC button (OK/FUNC) Setting using the control panel or function menu" (P.28)
"Operations using the control panel" (P.29)

FILE NAME **Resetting the file names of pictures**

RESET	The file number and folder number are reset every time a new card is inserted in the camera. The folder number returns to [No. 100] and the file number returns to [No. 0001].
AUTO	Even if a new card is inserted, the folder number and file number are retained from the previous card. This helps you to manage multiple cards.

Structure of file name and folder name

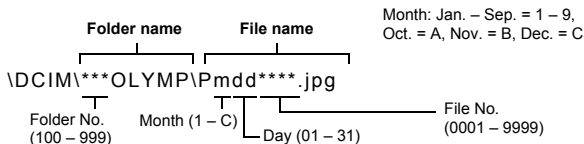

PIXEL MAPPING **Adjusting the image processing function**

The pixel mapping feature allows the camera to check and adjust the CCD and image processing functions. It is not necessary to operate this function frequently. Approximately once a year is recommended. Wait at least one minute after taking or viewing pictures to allow the pixel mapping function to perform properly. If you turn the camera off during pixel mapping, start again. Select [PIXEL MAPPING]. When [START] is displayed, press .

 **Adjusting the monitor brightness**



 : Brightens the monitor.

 : Darkens the monitor.

Press  after setting is complete.

 **Setting the date and time**

The date and time is saved with each image, and is used in the file name.

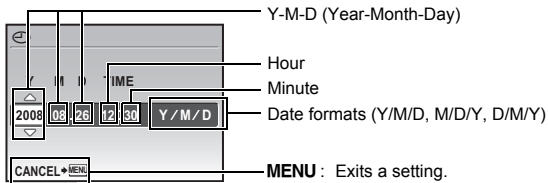

- The first two digits of the [Y] are fixed.
- The time is displayed in the 24-hour format.
- To set the time precisely, with the cursor at either "minute" or [Y/M/D], press  as the time signal strikes 00 seconds.

DUALTIME Setting the date and time in another time zone

OFF	Switches to the date and time set in [☺]. Pictures are recorded with the date and time set in [☺].
ON	Switches to the date and time set in [DUALTIME]. When setting the dual time, select [ON], and then set the time. Pictures are recorded with the date and time set in [DUALTIME].

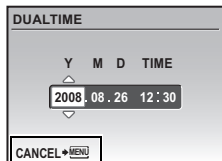

- The date format is the same as that set with [☺].
- The first two digits of the [Y] are fixed.
- The time is displayed in the 24-hour format.

MENU: Exits a setting.

ALARM CLOCK Setting alarms

OFF	No alarm is set or alarm is canceled.
ONE TIME	Alarm is activated once. After the alarm goes off, the setting is canceled.
DAILY	Alarm is activated daily at the set time.

- When [☺] has not been set, [ALARM CLOCK] is not available.
- When [SILENT MODE] is set to [ON], the alarm will not sound.
- When [DUALTIME] is set to [ON], the alarm sounds according to the dual time date and time setting.

Setting an alarm

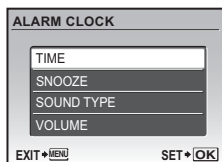

- Select [ONE TIME] or [DAILY], and set the alarm time.
- You can set snooze or alarm sounds and volume.

TIME	Sets the alarm time.	
SNOOZE	OFF	No snooze is set.
	ON	Alarm is activated every 5 minutes, up to 7 times.
SOUND TYPE	1 / 2 / 3	
VOLUME	LOW / HIGH	

Operating, shutting off and checking the alarm

- Operating the alarm:
Turn off the camera. The alarm only operates when the camera is off.
- Shutting off the alarm:
While the alarm is sounding, press any button to shut off the alarm and turn off the camera. After 1 minute of no operation, the alarm stops automatically and the camera turns off when [SNOOZE] is set to [OFF].
- Checking the alarm settings:
While the camera is off, press **DISP./** to display the set alarm time and the current time for 3 seconds.

VIDEO OUT Playing back pictures on a TV

 NTSC / PAL

The factory default settings differ according to the region where the camera is sold.

To play back camera images on a TV, set the video output according to your TV's video signal type.

- TV video signal types differ by country/region. Check the video signal type before connecting the camera to the TV.

NTSC : North America, Taiwan, Korea, Japan

PAL : European countries, China

Playing back pictures on a TV

Turn off the camera and the TV before connecting.

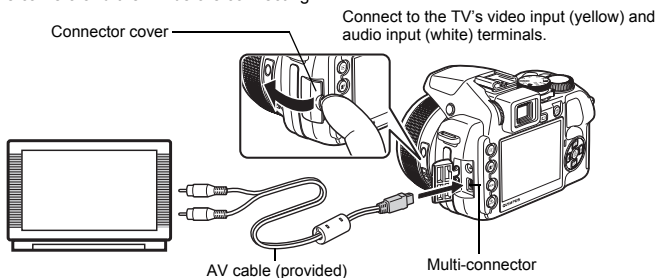
**Settings on the TV**

Turn the TV on, and set it to video input mode.

- For details of switching to video input, refer to your TV's instruction manual.
- Images and the information displayed on the screen may become cropped depending on the TV's settings.

Settings on the camera

Turn the camera on in playback mode.

- The last picture taken is displayed on the TV. Use the arrow pad to select the picture you want to display.

FRAME ASSIST Displaying the frame assist/Determining the type of frame assist

 OFF / [Grid icon] / [Envelope icon]

Press **DISP./** in shooting mode to determine the type of frame assist to be displayed.

When [OFF] is selected, pressing **DISP./** will not display the frame assist.

..... Displaying the histogram

OFF / ON / DIRECT

Press **DISP./** to determine whether to display the histogram.

- When set to [DIRECT], the black (blue) and white (red) areas are displayed directly on the picture.

MY MODE SETUP Setting and saving shooting-related functions

Types of my mode settings

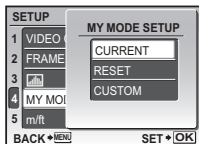

Select a MY MODE to save.

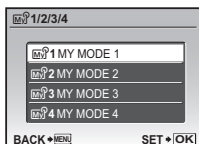

- * Default settings are saved only in [MY MODE 1].

CURRENT

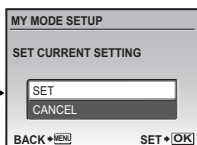

Saves the current camera settings.

- Select [SET], and press .

RESET

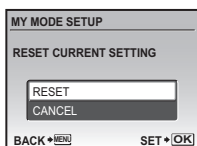

Restores the factory default settings.

- Select [RESET], and press .

CUSTOM

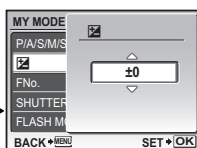

Saves settings one by one.

- Select the item to save in my mode, and press or .
- Change setting of the item, and press .

"Functions that can be assigned to My Mode/custom button" (P.78)

m/ft Setting the measurement unit during manual focus

m	Displays in meters and centimeters.
ft	Displays in feet and inches.

AEL/AFL BUTTON Registering the AE lock and AF lock functions

AE LOCK	Sets the function to lock the exposure.
AF LOCK	Sets the function to lock the focus position.
AF LOCK + AE LOCK	Sets the function to lock the focus position and exposure.

You can set the function when **AEL AFL** is pressed in shooting mode.

"**AEL AFL** Locking the focus position and exposure" (P.23)

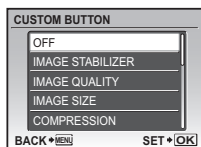
CUSTOM BUTTON Assigning functions to the custom button

- Select the function to be registered with \triangle / ∇ , and press Fn .
 Fn "Functions that can be assigned to My Mode/custom button" (P.78)

MANUAL FOCUS Selecting the focusing method in manual focus mode

\leftarrow \rightarrow BUTTONS	Use \leftarrow / \rightarrow to adjust the focus.
DIAL	Use the control dial to adjust the focus.
ZOOM RING	Use the zoom ring to adjust the focus.

- When [ZOOM RING] is selected in manual focus mode, the zoom ring cannot be used to zoom in and out.
- When [DIAL] is selected, the aperture value and shutter speed cannot be changed in **A**, **S** or **M** mode while adjusting the focus.

SLEEP Setting the sleep time

1MIN / 3MIN / 5MIN / 10MIN

To save battery power, the camera enters sleep mode when a certain amount of time has passed without any function being operated.

To reactivate the camera from sleep mode, press the shutter button, arrow pad or any button.

Printing pictures

Direct printing (PictBridge)

By connecting the camera to a PictBridge-compatible printer, you can print out pictures directly.

EASY PRINT Prints the picture displayed in the monitor by using the standard settings of your printer.

CUSTOM PRINT Prints with the various print settings.

- PictBridge is a standard for connecting digital cameras and printers of different makers and printing out pictures directly. To find out if your printer is compatible with PictBridge, refer to the printer's instruction manual.
- For printer's standard settings, available printing modes, the setting items such as paper sizes, and printer's specifications such as available types of paper, how to install the papers and ink cassettes, etc., refer to the printer's instruction manual.

EASY PRINT

- 1** In playback mode, display the picture you want to print out on the monitor.
- 2** Turn the printer on and plug the USB cable provided with the camera into the multi-connector of the camera and the printer's USB port.

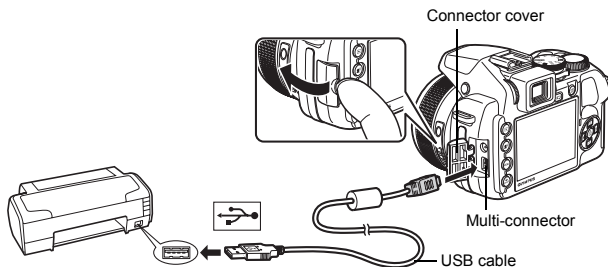

- The easy print start screen is displayed.

3 Press / .

- Printing starts.
- When printing is finished, the picture selection screen is displayed. To print another picture, press to select a picture, and press / .

4 Disconnect the USB cable.



Other print modes and print settings (CUSTOM PRINT)

- Follow Steps 1 and 2 on P. 59 to display the screen for Step 3 on P. 59, and then press .
- Select [CUSTOM PRINT], and press .

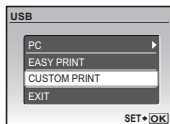

- Follow the operation guide to adjust print settings.

Selecting a print mode

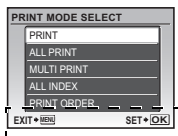

Operation guide

PRINT	Prints the selected picture.
ALL PRINT	Prints all the pictures stored in the internal memory or the card.
MULTI PRINT	Prints one picture in multiple layout format.
ALL INDEX	Prints an index of all the pictures stored in the internal memory or the card.
PRINT ORDER	Prints the pictures according to the print reservation data on the card.  "Print settings (DPOF)" (P. 61)

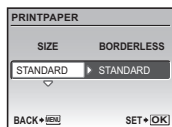

Setting the print paper



SIZE	Choose from the available paper sizes on your printer.
BORDERLESS	Select with or without borders. In [MULTI PRINT] mode, you cannot print with a border.
PICS/SHEET	Select the number of pictures to be laid out on a sheet of paper. Available in [MULTI PRINT] mode only.

- If the [PRINTPAPER] screen is not displayed, [SIZE], [BORDERLESS] and [PICS/SHEET] are set to the standard.

Selecting the picture to print

Press   to select the picture you want to print. Or you can turn the control dial and select a picture from the index display.



PRINT	Prints one copy of the selected picture. When [SINGLE PRINT] or [MORE] has been selected, a single copy or more copies are printed.
SINGLE PRINT	Makes a print reservation for the displayed picture.
MORE	Sets the number of prints and data to be printed for the displayed picture.

Setting the number of prints and data to be printed

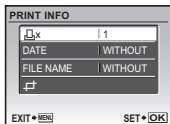

	Sets the number of prints. You can select up to 10 prints.
DATE (🕒)	If you select [WITH], pictures are printed with the date.
FILE NAME (📄)	If you select [WITH], pictures are printed with the file name.
	Use the arrow pad and the control dial to adjust the trimming size and position, and press . The trimmed picture is printed.

4 Select [PRINT], and press .

- Printing starts.
- When [OPTION SET] is selected in [ALL PRINT] mode, [PRINT INFO] screen is displayed.
- When printing is finished, the [PRINT MODE SELECT] screen is displayed.

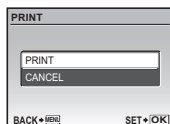

To cancel printing

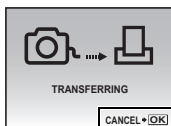

Screen during data transfer

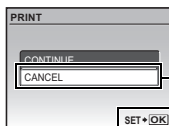

Select [CANCEL], and press .

5 In the [PRINT MODE SELECT] screen, press MENU.

- A message is displayed.

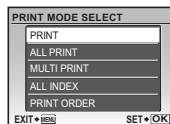

6 Disconnect the USB cable.

Print settings (DPOF)

Print reservation allows you to save printing data (the number of prints and the date and time information) with the pictures stored on the card.

With print reservation, you can print out pictures easily either at home using a personal DPOF-compatible printer or at a photo store that supports DPOF. DPOF is a standard format used to record automatic print information from digital cameras.

- Only the images stored on the card can be reserved to print. Insert a card with recorded pictures into the camera before making print reservations.
- DPOF reservations set by another device cannot be changed by this camera. Make changes using the original device. If a card contains DPOF reservations set by another device, entering reservations using this camera may overwrite the previous reservations.
- You can make DPOF print reservations for up to 999 images per card.
- Not all functions may be available on all printers, or at all photo stores.

Making a print reservation

- 1 Press **MENU** in the playback mode and select **[PRINT ORDER]**.
- 2 Select **[]** or **[ALL]**, and press .





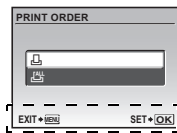

Makes a print reservation for the selected picture.
Makes print reservations for all the pictures stored on the card.

- When **[ALL]** is selected, go to step 5.



Operation guide

When **[]** is selected

- 3 Press   to select the frames for print reservations, and then press   to set the number of prints.

- You cannot make print reservations for pictures with .
- Repeat Step 3 to make print reservations for other pictures.

To trim the picture

- Use the control dial to display the trimming line.
- Use the arrow pad and the control dial to adjust the trimming size and position, and press .

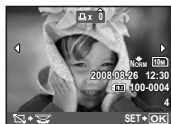

- 4 When you finish making print reservations, press .

- 5 Select the date and time print setting, and press .

NO The pictures are printed without the date and time.

DATE The selected pictures are printed with the shooting date.

TIME The selected pictures are printed with the shooting time.

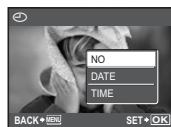

- 6 Select **[SET]**, and press .

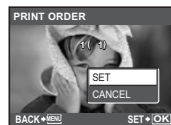



Resetting print reservation data

You can reset all the print reservation data or just for selected pictures.





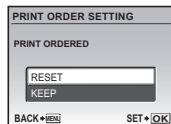

- 1 Select top menu ► **[PRINT ORDER]**, and press .

To reset the print reservation data for all the pictures

- 2 Select **[]** or **[ALL]**, and press .
- 3 Select **[RESET]**, and press .



To reset the print reservation data for a selected picture

- 2** Select [□], and press .
- 3** Select [KEEP], and press .
- 4** Press  to select the picture with the print reservations you want to cancel, and press  to decrease the number of prints to 0.
 - Repeat Step 4 to cancel print reservations for other pictures.
- 5** When you are finished canceling print reservations, press .
- 6** Select the date and time setting, and press .
- The setting is applied to the remaining pictures with print reservations.
- 7** Select [SET], and press .

Using OLYMPUS Master

Using the USB cable provided with your camera, you can connect the camera and computer and download (transfer) the images to your computer using the OLYMPUS Master software, also provided with the camera.

Prepare the following items before starting.



OLYMPUS Master 2
CD-ROM



USB cable

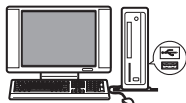

A computer that satisfies the operating
environment (P. 64) requirements

What is OLYMPUS Master?

OLYMPUS Master is a software application for managing your digital images on your computer.

Install the OLYMPUS Master software

Before installing the OLYMPUS Master software, please confirm that your computer is compatible with the following system requirements. For newer operating systems, please refer to the Olympus web site as shown on the back cover of this manual.

Operating environment

	Windows	Macintosh
OS	Windows 2000 Professional/XP Home Edition/XP Professional/Vista	Mac OS X v10.3 or later
CPU	Pentium III 500 MHz or later	Power PC G3 500 MHz or later Intel Core Solo/Duo 1.5 GHz or later
RAM	256 MB or more	256 MB or more
Hard disk capacity	500 MB or more	500 MB or more
Monitor	1,024 × 768 pixels or more 65,536 colors or more (16.77 million colors or more recommended)	1,024 × 768 pixels or more 32,000 colors or more (16.77 million colors or more recommended)
Other	USB port or IEEE 1394 port Internet Explorer 6 or later QuickTime 7 or later recommended DirectX 9 or later recommended	USB port or IEEE 1394 port (FireWire) Safari 1.0 or later (1.3 or later recommended) QuickTime 6 or later

Note

- Use a computer with a pre-installed operating system. Operations are not guaranteed on home-built computers or computers with an updated operating system.
- Operations are not guaranteed when using an added USB or IEEE 1394 (FireWire) port.
- To install the software, you must log on as a user with administrators' privileges.
- If you are using Macintosh, be sure to remove the media (drag & drop onto the trash icon) before performing the following operations. Failure to do so could result in unstable computer operation and the need to reboot.
 - Disconnect the cable connecting the camera to the computer
 - Turn off the camera
 - Open the camera's battery/card compartment cover

For how to install the OLYMPUS Master software, refer to the installation guide included in the CD-ROM.

Connecting the camera to a computer

1 Make sure the camera is turned off.

- The monitor and viewfinder are off.
- The lens is retracted.

2 Connect the multi-connector on the camera to the USB port on the computer using the provided USB cable.

- Refer to your computer's instruction manual to locate the position of the USB port.
- The camera turns on automatically.
- The monitor turns on and the selection screen for the USB connection is displayed.

3 Select [PC], and press .

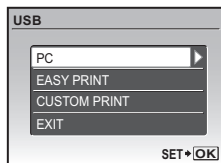
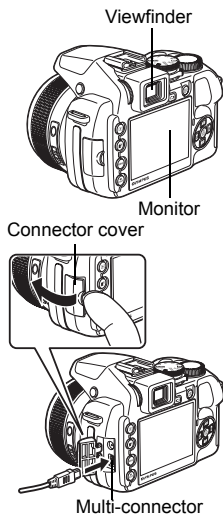

4 The camera is recognized by the computer.

• Windows

When you connect the camera to your computer for the first time, the computer attempts to recognize the camera. Click "OK" to exit the message that is displayed. The camera is recognized as a "Removable Disk".

• Macintosh

The iPhoto program is the default application for managing digital images. When you connect your digital camera for the first time, the iPhoto application starts automatically, so close this application and start OLYMPUS Master.

! Note

- The camera functions are disabled while the camera is connected to a computer.
- Connecting the camera to a computer via a USB hub may cause unstable operation. In this case, do not use a hub, but connect the camera directly to the computer.
- Images cannot be transferred to your computer with OLYMPUS Master if [PC] is selected in Step 3, [D] is pressed and [MTP] is selected.

Start up the OLYMPUS Master software

Windows

- 1 Double-click the "OLYMPUS Master 2" icon  on the desktop.



Macintosh

- 1 Double-click the "OLYMPUS Master 2" icon  in the "OLYMPUS Master 2" folder.

- The browse window is displayed.
- When OLYMPUS Master is started up for the first time after installation, the OLYMPUS Master initial setting screen and user registration screen are displayed before the browse window. Follow the on-screen instructions.

Displaying camera images on a computer

Downloading and saving images

- 1 Click "Transfer Images"  on the browse window, and then click "From Camera" .
 - The window for selecting the pictures you want to transfer from the camera is displayed. All the images in the camera are displayed.
- 2 Select "New Album" and enter an album name.
- 3 Select the image files and click "Transfer Images".
 - A window indicating that the download is complete is displayed.
- 4 Click "Browse images now".
 - The downloaded images are displayed in the browse window.

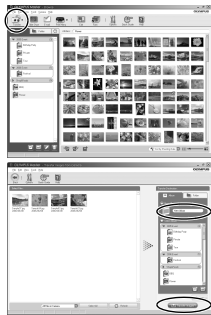

To disconnect the camera

- 1 Make sure that the card access lamp has stopped blinking.

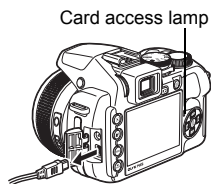

- 2 Make the following preparations for disconnecting the USB cable.

Windows

- 1 Click the "Unplug or Eject Hardware" icon  in the system tray.
- 2 Click the message that is displayed.
- 3 When a message is displayed saying that the hardware can be ejected safely, click "OK".

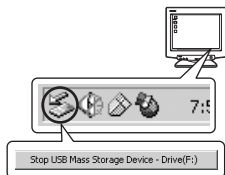

Macintosh

- 1 The trash icon changes to the eject icon when the "Untitled" or "NO_NAME" icon on the desktop is dragged. Drag and drop it on the eject icon.



- 3 Disconnect the USB cable from the camera.

Note

- Windows: When you click "Unplug or Eject Hardware", a warning message may be displayed. Make sure that image data is not being downloaded from the camera and that all applications are closed. Click the "Unplug or Eject Hardware" icon again and disconnect the cable.

For detailed operations of OLYMPUS Master, refer to the quick start guide displayed upon startup or the help of the OLYMPUS Master.

To download and save images to a computer without using OLYMPUS Master

This camera is compatible with USB mass storage. You can connect the camera to your computer using the USB cable provided with the camera to download and save images without using OLYMPUS Master. The following environment is required to use the USB cable to connect the camera to your computer.

Windows: Windows 2000 Professional/XP Home Edition/XP Professional/Vista

Macintosh: Mac OS X v10.3 or later

Note

- If your computer is running Windows Vista, you can select [PC] in Step 3 on P. 65, press \triangleright , and select [MTP] to use Windows Photo Gallery.
- Data transfer is not guaranteed in the following environments, even if your computer is equipped with a USB port.
 - Computers with a USB port added by means of an extension card, etc.
 - Computers without a factory-installed OS and home-built computers

Getting to know your camera better

Shooting tips and information

Tips before you start taking pictures

The camera does not turn on even when the batteries are loaded

The direction of the batteries is incorrect.

- Insert the batteries in the correct direction.

The battery power is exhausted

- Insert new batteries. When using rechargeable batteries, charge the batteries.

The battery is temporarily unable to function because of the cold

- Battery performance declines in low temperatures, and the charge may not be sufficient to turn on the camera. Remove the battery and warm it by putting it in your pocket for a while.

The card cannot be used

- If the contact area of the card is contaminated, data in the card cannot be read and the [CARD SETUP] screen may appear. In this case, select [CLEAN CARD], press , remove the card, and then wipe the contact area with a soft dry cloth.

No picture is taken when the shutter button is pressed

The camera is in sleep mode

- To save battery power, the camera automatically enters sleep mode and the monitor turns off if there is no operation for a certain amount of time when the camera is turned on (the lens is extended and the monitor is on). You can select the time to enter the sleep mode from 1, 3, 5 or 10 minutes. No picture is taken even if the shutter button is fully pressed in this mode. Operate the shutter button or other buttons to restore the camera from sleep mode before taking a picture. If the camera is further left for 12 minutes, it automatically turns off (the lens retracts and the monitor turns off). Return the power switch to OFF and then set the power switch to ON.

 "SLEEP Setting the sleep time" (P.58)

The mode dial is set to 

- This is the playback mode for displaying pictures on the monitor. Set the mode dial to a shooting mode.

The mode dial is set to **GUIDE**

- No pictures can be taken when the shooting guide is being displayed. Take a picture after making the settings following the shooting guide, or turn the mode dial and set it to the position other than **GUIDE** in the shooting mode.

The flash is charging

- Wait until  (flash charge) stops blinking before taking the picture.

The camera's internal temperature increases

- With prolonged camera use, the internal temperature may increase, resulting in automatic shutdown. If this occurs, remove the battery from the camera and wait until the camera has sufficiently cooled. The camera's external temperature may also increase during use, however this is normal and does not indicate malfunction.

The viewfinder does not turn on

The monitor is turned on

- Press  to switch to the viewfinder.

The monitor does not turn on

The viewfinder is turned on

- Press  to switch to the monitor.

The viewfinder or monitor is hard to see

There is condensation* inside the camera

- Turn the camera off. Before turning it on again, wait until the camera adjusts to the surrounding temperature and dries out.
- * When it is cold outside, the water vapor in the air is rapidly cooled and turns to droplets of water. Condensation occurs when the camera is suddenly taken from a cold place into a warm room.

Vertical lines appear on the monitor screen during shooting



- Aiming the camera at a bright subject in sunlight may cause vertical lines to appear on the screen. This is not a malfunction.

The viewfinder is not properly adjusted

- Rotate the dioptre adjustment dial slightly and adjust.
-  "Adjusting the viewfinder's focus using the diopter" (P.9)

The date and time have not been set

The camera has been used in the same conditions from the time of purchase

- No date and time have been set for the camera at the time of purchase. Set the date and time before using the camera.
-  "Turn the camera on" (P.6)
-  "Setting the date and time" (P.54)

The battery has been pulled out of the camera

- The date and time settings will be returned to the factory default settings if the camera is left without batteries for approximately 3 days. In addition, if the batteries are inserted in the camera for a short period, the date and time settings will be returned to the factory default settings more quickly. Before taking important pictures, check that the date and time settings are correct.

Shooting tips

Focusing on the subject

There are several ways to focus, depending on the subject.

When the subject is not in the center of the frame

- Place the subject in the center of the frame, lock the focus on the subject, and then recompose your picture.
- Set [AF MODE] to [AREA].
-  "AF MODE Changing the focusing area" (P.41)

The subject is moving quickly

- Focus the camera on a point roughly the same distance away as the subject you want to shoot and lock the focus (by pressing the shutter button halfway). Then recompose your picture and press the shutter button completely as the subject enters the frame.
- Set the mode dial to **S** to set the shutter speed, and then take the picture. Setting a fast shutter speed lets you capture fast-moving subjects as though they were standing still.
-  "**S** Changing the shutter speed for shooting pictures" (P.17)

The subject is dark.

- Set [AF ILLUMINAT.] to [ON].
-  "AF ILLUMINAT. Setting to light the illuminator in a dark place" (P.42)

Subjects that are difficult to focus on

- Under certain types of conditions, it is difficult to focus using auto focus.



Subject with low contrast



Subject with an extremely bright area in the center of the frame

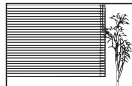

Subject without vertical lines



Subjects at different distances

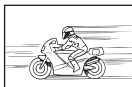

Fast-moving subject



The subject is not in the center of the frame

In these cases, focus (focus lock) on an object with high contrast at the same distance as the intended subject, recompose your shot and then take the picture. If the subject has no vertical lines, hold the camera vertically and focus the camera using the focus lock function by pressing the shutter button halfway, and then return the camera to the horizontal position while keeping the button pressed halfway and take the picture.

Prevent blur by using image stabilization

Be sure to hold the camera firmly with both hands and press the shutter button slowly so as to avoid moving the camera. You can reduce blur when shooting by setting [IMAGE STABILIZER] to [ON].

"IMAGE STABILIZER Shooting pictures using digital image stabilization" (P.42)

Pictures are more likely to be blurry when:

- images are shot at a high-magnification zoom setting, i.e. using both optical zoom and digital zoom functions,
- the object is dark and the shutter speed is slow, or
- the flash cannot be used or when a slow shutter speed set **SCN** mode is selected.

Taking stabilized pictures without the flash

To take pictures in low light places without flash, set the following after setting the flash mode to [Ⓜ] (Flash off).

Increase the [ISO] setting

"ISO Changing the ISO sensitivity" (P.40)

The picture is too grainy

There are several factors that can cause the picture to appear grainy.

Using the digital zoom to take close-up pictures

- With the digital zoom, part of the image is cropped and enlarged. The greater the magnification, the grainier the picture appears.

"DIGITAL ZOOM Zooming in on your subject" (P.41)

Increasing the ISO sensitivity





- When you increase the [ISO] setting, "noise", which appears as spots of unwanted color or unevenness in the color, can be introduced and give the picture a grainy appearance. This camera is equipped with a function to allow shooting at high sensitivity while suppressing noise; however, increasing the ISO sensitivity creates grainier pictures than when using a lower sensitivity.

"ISO Changing the ISO sensitivity" (P.40)

Taking pictures with the correct color

- The reason why there are differences between the colors in a picture and the actual colors taken and the actual color is the light source illuminating the subject. [WB] is the function that allows the camera to determine the correct colors. Normally, the [AUTO] setting provides the optimal white balance, but depending on the subject, it may be better to experiment with changing the [WB] setting.
 - When the subject is in the shade on a sunny day
 - When the subject is illuminated by both natural light and indoor lighting, such as when near a window
 - When there is no white in the center of the frame
- ☞ "WB Adjusting the color of a picture" (P.39)
- ☞ "[WB7] Adjusting the white balance compensation" (P.43)







Taking pictures of a white beach or snow scene

- Take pictures with  or  in **SCN** mode. Suitable for taking pictures on a sunny day at the beach or in the snow.
- ☞ "**SCN** Shoot pictures by selecting a scene mode according to the situation" (P.18)
- Often, bright subjects (such as snow) turn out darker than their natural colors. Adjust  toward [+] to make these subjects closer to their real shades. Conversely, when you are shooting dark subjects, it can be effective to adjust toward the [-]. Sometimes, using the flash may not produce the brightness (exposure) that was intended.
- ☞ " button Changing picture brightness (Exposure Compensation)" (P.22)

Misalignment of panoramic pictures

- Panning along the camera central axis reduces picture misalignment. When you shoot close subjects, panning along the axis of the lens gives good results.
- In [COMBINE IN CAMERA1] mode, the camera automatically detects its own position except for the following cases (In such cases, use [COMBINE IN CAMERA 2] or [COMBINE IN PC].):
 - when panning the camera in a quick or unsteadily manner.
 - when shooting a low contrast subject (blue sky, etc.).
 - when shooting a moving subject framed in full screen.
 - when panning the camera with no images on-screen.

Taking pictures of a subject against backlight

- When Shadow Adjustment Technology is set to [ON], the face of the subject will appear brighter even against backlight. This function is also effective when shooting indoor pictures from outdoor.
- ☞ " Brightening the subject against backlight (Shadow Adjustment Technology)" (P.25)
- With [METERING] set to [], the picture can be taken based on the brightness of the subject in the AF target mark area without being affected by the light in the background.
- ☞ "**METERING** Changing the area for measuring the brightness of a subject" (P.41)
- Set the flash to [] (Fill-in flash) to activate fill-in-flash. You can shoot a subject against backlight without the face of the subject appearing dark. [] (Fill-in flash) is effective for shooting against backlight and under fluorescent and other artificial lighting.
- ☞ " button Flash shooting" (P.23)
- It is effective to set the exposure compensation to [+] by pressing  when shooting against strong backlighting.
- ☞ " button Changing picture brightness (Exposure Compensation)" (P.22)
- With [AF MODE] set to [FACE DETECT], the face of the subject will be given due exposure even against backlight and it will appear brighter.
- ☞ "AF MODE Changing the focusing area" (P.41)

When the subject is too bright or too dark

- When taking pictures in **S** mode or **A** mode, the shutter speed or aperture setting may be displayed in red. A red display means that the correct exposure cannot be obtained. If you take the picture as is, the picture will appear too bright or too dark. In this case, use the control dial to change the settings.

- ☞ **A** Changing the aperture value for shooting pictures" (P.17)
- ☞ **S** Changing the shutter speed for shooting pictures" (P.17)

Additional shooting tips and information

Increasing the number of pictures that can be taken

There are two ways to record the pictures you take with this camera.

Recording pictures to the internal memory

- Pictures are recorded to the internal memory, and when the number of storable still pictures reaches 0, you must connect the camera to a computer to download the pictures, and then erase the pictures from the internal memory.

Using a card (xD-Picture Card) (optional)

- Pictures are recorded to the card when inserted in the camera. When the card is full, download the pictures to a computer, and then either erase the pictures from the card or use a new card.
- Pictures are not recorded to the internal memory when a card is inserted in the camera. Pictures in the internal memory can be copied to the card using the [BACKUP] function.

- ☞ "BACKUP Copying pictures in the internal memory to the card" (P.52)
- "The card" (P.85)

Number of storable still pictures and recording length of movies

Still pictures

IMAGE SIZE		COMPRES- SION	Number of storable still pictures			
			Internal memory		Using a 1GB card	
			With sound	Without sound	With sound	Without sound
RAW	3648 × 2736	Uncompressed	3	3	68	69
10M	3648 × 2736	FINE	9	9	204	205
		NORM	18	18	397	402
5M	2560 × 1920	FINE	18	18	404	410
		NORM	35	35	770	789
3M	2048 × 1536	FINE	27	28	615	627
		NORM	51	53	1142	1184
2M	1600 × 1200	FINE	43	44	954	984
		NORM	76	80	1683	1776
1M	1280 × 960	FINE	63	66	1390	1453
		NORM	107	116	2369	2558
VGA	640 × 480	FINE	223	264	4920	5814
		NORM	363	484	7995	10660
16:9	1920 × 1080	FINE	40	41	888	913
		NORM	72	76	1599	1683

IMAGE SIZE		FRAME RATE	Continuous recording length			
			Internal memory		Using a 1 GB card	
			With sound	Without sound	With sound	Without sound
VGA	640 × 480	30	25 sec.	25 sec.	9 min. 25 sec.	9 min. 28 sec.
		15	51 sec.	51 sec.	18 min. 44 sec.	18 min. 56 sec.
QVGA	320 × 240	30	1 min. 9 sec.	1 min. 10 sec.	25 min. 26 sec.	25 min. 49 sec.
		15	2 min. 16 sec.	2 min. 20 sec.	50 min. 7 sec.	51 min. 38 sec.

Using a new card

- If you use a non-Olympus card or a card used for another application, such as for a computer, use [FORMAT] function to format the card.
-  "MEMORY FORMAT (FORMAT) Formatting the internal memory or card" (P.52)



The card access lamp is blinking

- An image or movie is being recorded or downloaded (when connected to a computer).
- Do not do any of the following while the card access lamp is blinking. Doing so may prevent the image data from being saved and render the internal memory or card unusable.
 - Open the battery/card compartment cover.
 - Remove the battery and card.
 - Disconnect the USB cable.

Extending the useful life of the battery



- Performing any of the following operations when not actually taking pictures can deplete the battery power.
 - The shutter button is pressed halfway repeatedly in shooting mode, activating the auto focus and digital image stabilization.
 - Using the zoom repeatedly.
 - [FULLTIME AF] is set to [ON].
 - The monitor is left on for an extended period of time.
 - The camera is connected to a computer or printer.

Functions that cannot be selected from menus/buttons

- Some items may not be selectable from the menus when using the arrow pad. (Menu items displayed in gray cannot be selected.)
 - Items that cannot be set with the current shooting mode
 - Items that cannot be set because of an item that has already been set: When the focus mode is set to [MF], [AF MODE] cannot be selected.
- Some items cannot be set when the button is pressed.
 -  and .
- The function settings cannot be changed when the mode dial is set to **GUIDE**.
- Some functions cannot be used when there is no card in the camera.
 - [PANORAMA]/[PRINT ORDER]/[FORMAT]/[BACKUP]

Restoring default settings

- This camera retains a part of the settings even after the power is turned off. To return the settings to default settings, execute [RESET].

When the mode dial is set to **P**, **A**, **S**, **M** or : the settings are retained even after the power is turned off (except for the settings of , [PANORAMA] and [TIMELAPSE] shootings).

When the mode dial is set to **AUTO** or **SCN**: the settings return to default (except for [IMAGE QUALITY]).

-  "RESET Change the shooting functions back to default settings" (P.35)

Confirming the exposure when the monitor is difficult to see outdoors

The monitor may be difficult to see (and the exposure difficult to confirm) when shooting under bright light.



Press **DISP./** repeatedly to display the histogram

- Set the exposure so that the graph is concentrated on the outer edges and the graph is balanced on both sides.

How to read the histogram

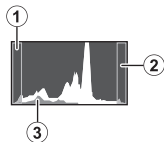
- ① If the peak fills too much of the frame, the image will appear mostly black.
- ② If the peak fills too much of the frame, the image will appear mostly white.
- ③ The part indicated in green in the histogram shows the luminance distribution within the AF target mark.



-  **DISP./** button Changing the information on display/ Displaying the menu guide/Checking the time" (P.26)

Using the viewfinder

-  "[] button Monitor/Viewfinder" (P.22)

Playback help and troubleshooting tips

The red-eye cannot be fixed

- Depending on the picture, the red-eye may not be fixed. Also, parts except the eye may be fixed.

The light is caught in the picture



- The light may be caught in the picture being reflected by the dusts in the air, when shooting with flash in the night.



Playback tips

Playing back the picture in the internal memory

- When a card has been inserted in the camera, the picture in the internal memory cannot be played back. Turn off the camera and remove the card to playback pictures stored in the camera's internal memory.

Understanding the settings and other information of pictures taken



- Play back a picture, and press **DISP./**. Press **DISP./** repeatedly to change the amount of information displayed.

-  **DISP./** button Changing the information on display/Displaying the menu guide/ Checking the time" (P.26)

Quickly displaying a desired picture

- Turn the control dial in playback mode to view the pictures as thumbnails (index display) or in a calendar format (calendar display).
-  "Control dial Index display/Calendar display/Close-up playback" (P.22)

Erasing sound recorded to still pictures

- Once sound is added to a picture, it is not possible to erase the sound. In this case, make a re-recording with silence. Sound recording is not possible if there is insufficient space in the internal memory or on the card.
-   "Adding sound to still pictures" (P.50)

Viewing pictures on a computer

Viewing the entire picture on a computer screen

The size of the picture displayed on a computer screen changes depending on the computer settings. When the monitor setting is 1024 × 768 and you are using Internet Explorer to view a picture with an image size of 2048 × 1536 at 100 %, the entire picture cannot be viewed without scrolling. There are several ways you can view the entire picture on the computer screen.











View the picture using image browsing software







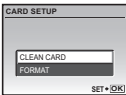

- Install the OLYMPUS Master 2 software from the provided CD-ROM.

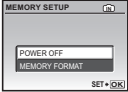
Change the monitor setting



- The icons on the computer desktop may be rearranged. For details of changing the settings on your computer, refer to the computer's instruction manual.

When you get an error message on the camera

Monitor indication	Possible cause	Corrective action
 CARD ERROR	There is a problem with the card.	This card cannot be used. Insert a new card.
 WRITE PROTECT	Writing to the card is prohibited.	The recorded image has been protected (read-only) on a computer. Download the image to a computer and cancel the read-only setting.
 MEMORY FULL	The internal memory has no available memory and cannot store any new data.	Insert a card or erase unwanted data. Before erasing, backup the data of important pictures onto the card, or download such pictures to a computer.
 CARD FULL	The card has no available memory and cannot store any new data.	Replace the card or erase unwanted data. Before erasing, download important pictures to a computer.
 NO PICTURE	There are no pictures in the internal memory or on the card.	The internal memory or the card contains no pictures. Record pictures.
 PICTURE ERROR	There is a problem with the selected picture and it cannot be played back on this camera.	Use image processing software to view the picture on a computer. If that cannot be done, the image file is damaged.
 THE IMAGE CANNOT BE EDITED	If pictures taken by other cameras are selected, they cannot be edited.	Use image processing software to edit the pictures.
 CARD-COVER OPEN	The card cover is open.	Close the card cover.
 BATTERY EMPTY	The battery is empty.	Insert new batteries. When using rechargeable batteries, charge the batteries.
Recording has stopped to allow camera to cool. Please wait a moment.	When [IMAGE STABILIZER] is set to [ON], the camera's internal temperature rises due to continuous movie recording for a long period, thereby causing shooting to stop.	Allow the camera to cool down for some time before you begin shooting again. Or you can shoot with [IMAGE STABILIZER] set to [OFF].
Camera is cooling. Please wait a moment.		
	Data in the card cannot be read. Or, the card is not formatted.	<ul style="list-style-type: none"> • Select [CLEAN CARD], and press . • Select [FORMAT] ▶ [YES] and press . All data on the card is erased.

Monitor indication	Possible cause	Corrective action
	There is an error in the internal memory.	Select [MEMORY FORMAT] ▶ [YES] and press  . All data in the internal memory is erased.
 NO CONNECTION	The camera is not connected to the computer or printer correctly.	Disconnect the camera and connect it again correctly.
 NO PAPER	There is no paper in the printer.	Load some paper in the printer.
 NO INK	The printer has run out of ink.	Replace the ink cartridge in the printer.
 JAMMED	The paper is jammed.	Remove the jammed paper.
SETTINGS CHANGED	The printer's paper tray has been removed or the printer has been operated while changing settings on the camera.	Do not operate the printer while changing settings on the camera.
 PRINT ERROR	There is a problem with the printer and/or camera.	Turn off the camera and printer. Check the printer and remedy any problems before turning the power on again.
 CANNOT PRINT	Pictures recorded on other cameras may not be printed on this camera.	Use a computer to print.

Functions that can be assigned to My Mode/custom button

Function	MY MODE SETUP	CUSTOM BUTTON	Ref. Page
P/A/S/M/SCENE	✓	—	P.6
	✓	—	P.22
FNo.	✓	—	P.17
SHUTTER	✓	—	P.17
FLASH MODE	✓	—	P.23
	✓	—	P.27
	✓	—	P.28
	✓	—	P.25
MONITOR (I/O) ^{*1}	✓	—	P.22
ZOOM ^{*2}	✓	—	—
IMAGE QUALITY	✓	✓	P.34
IMAGE SIZE	✓	✓	P.34
COMPRESSION	✓	✓	P.34
WB	✓	—	P.39
ISO	✓	—	P.40
DRIVE	✓	—	P.40
FINE ZOOM	✓	✓	P.41
DIGITAL ZOOM	✓	✓	P.41
METERING	✓	—	P.41
AF MODE	✓	✓	P.41
FULLTIME AF	✓	✓	P.42
AF PREDICT	✓	✓	P.42
AF ILLUMINAT.	✓	—	P.42
IMAGE STABILIZER	✓	✓	P.42
	✓	—	P.42
 FLASH	✓	✓	P.43
 (still pictures)	✓	✓	P.43
	✓	—	P.43
PICTURE MODE	✓	—	P.43
SHARPNESS	✓	—	P.44
CONTRAST	✓	—	P.44
SATURATION	✓	—	P.44
NOISE REDUCT.	✓	✓	P.44
TIMELAPSE	✓	—	P.45
 (conversion lens)	✓	—	P.45
INFO	✓	—	P.26
FRAME ASSIST	✓	—	P.56
	✓	—	P.57













*1 Set whether to use the monitor or viewfinder.







*2 For [ZOOM], select from 26 mm, 50 mm, 150 mm, 300 mm or 520 mm. (These numbers are based on the focal length of a 35 mm camera.)



Functions available in shooting modes

Some functions cannot be set in certain shooting modes. For more details, refer to the table below. In  mode, available functions vary depending on the modes set in the [MY MODE SETUP] menu.

In **SCN** mode, the settings are optimized for the shooting situation. To ensure the best effect, setting restrictions apply to certain functions (indicated by ).

Function	Shooting mode	AUTO	P	A	S	M	SCN		Ref. Page
Flash mode	AUTO	✓	✓	✓	—	—		—	P.23
		✓	✓	✓	—	—		—	P.23
		✓	✓	✓	✓	✓		—	P.23
		✓	✓	✓	✓	✓		—	P.23
	 SLOW	✓	✓	✓	✓	✓		—	P.23
	 SLOW	✓	✓	✓	✓	✓		—	P.23
	 SLOW2	✓	✓	✓	✓	✓		—	P.24
	✓	✓	✓	✓	✓		—	P.23	
		✓	✓	✓	✓	—	✓	✓	P.22
Aperture value		—	—	✓	—	✓	—	—	P.17
Shutter speed		—	—	—	✓	✓	—	—	P.17
		✓	✓	✓	✓	✓		✓	P.27
		✓	✓	✓	✓	✓		✓	P.27
		✓	✓	✓	✓	✓		✓	P.28
INFO		✓	✓	✓	✓	✓	✓	—	P.26
Optical zoom		✓	✓	✓	✓	✓		✓ ¹	P.21
AE LOCK		—	✓	✓	✓	—		—	P.23
AF LOCK		—	✓	✓	✓	✓		—	P.23
AF LOCK + AE LOCK		—	✓	✓	✓	—		—	P.23
		✓	✓	✓	✓	✓		✓	P.25
IMAGE QUALITY		—	✓	✓	✓	✓	—	—	P.34
IMAGE SIZE		✓	✓	✓	✓	✓		✓	P.34
COMPRESSION		✓	✓	✓	✓	✓		—	P.34
FRAME RATE		—	—	—	—	—	—	✓	P.35
WB		—	✓	✓	✓	✓	✓	✓	P.39
ISO		—	✓	✓	✓	✓ ²		—	P.40
DRIVE		—	✓	✓	✓	✓ ³		—	P.40
FINE ZOOM		—	✓	✓	✓	✓		—	P.41
DIGITAL ZOOM		—	✓	✓	✓	✓		✓	P.41
METERING		—	✓	✓	✓	✓		✓	P.41

Function	Shooting mode								Ref. Page
	AUTO	P	A	S	M	SCN			
AF MODE	—	✓	✓	✓	✓		—	P.41	
Focus mode	—	✓	✓	✓	✓		—	P.24	
FULLTIME AF	—	✓	✓	✓	✓		✓	P.42	
AF PREDICT	—	✓	✓	✓	✓		—	P.42	
AF ILLUMINAT.	—	✓	✓	✓	✓		—	P.42	
IMAGE STABILIZER	—	✓	✓	✓	✓	✓	✓	P.42	
	—	✓	✓	✓	✓		—	P.42	
 FLASH	—	✓	✓	✓	✓		—	P.43	
 (still pictures)	—	✓	✓	✓	✓		—	P.43	
PANORAMA	—	✓	—	—	—		—	P.36	
	—	✓	✓	✓	✓	✓	✓	P.43	
PICTURE MODE	—	✓	✓	✓	✓	—	—	P.43	
SHARPNESS	—	✓	✓	✓	✓	✓	✓	P.44	
CONTRAST	—	✓	✓	✓	✓	✓	✓	P.44	
SATURATION	—	✓	✓	✓	✓	✓	✓	P.44	
NOISE REDUCT.	—	✓	✓	✓	✓ ^{*4}		—	P.44	
TIMELAPSE	—	✓	✓	✓	✓		—	P.45	
 (conversion lens)	—	✓	✓	✓	✓		✓	P.45	
 (movies)	—	—	—	—	—	—	✓	P.45	

*1 When  (movies) is set to [ON], optical zoom cannot be used during the shooting. To zoom in when  (movies) is set to [ON], set [DIGITAL ZOOM] to [ON].

*2 [AUTO] and [HIGH ISO AUTO] are not available.

*3 [BKT] is not available.

*4 This is fixed at [ON] during bulb shooting.

Camera care

Cleaning the camera

Exterior:

- Wipe gently with a soft cloth. If the camera is very dirty, soak the cloth in mild soapy water and wring well. Wipe the camera with the damp cloth and then dry it with a dry cloth. If you have used the camera at the beach, use a cloth soaked in clean water and wrung well.

Monitor and viewfinder:

- Wipe gently with a soft cloth.

Lens

- Blow dust off the lens with a commercial blower, then wipe gently with a lens cleaner.

Note

- Do not use strong solvents such as benzene or alcohol, or chemically treated cloth.
- Mold may form on the lens surface if the lens is left dirty.

Storage

- When storing the camera for extended periods, remove the battery, AC adapter and card, and keep in a cool, dry place that is well ventilated.
- Periodically insert the battery and test the camera functions.

Note

- Avoid leaving the camera in places where chemical products are handled since this may result in corrosion.

Battery Handling Precautions

- In addition to the batteries provided with the camera, the following types of battery can be used. Choose the power source best suited to the situation.

AA alkaline batteries

The number of pictures that you can take may vary considerably depending on the battery manufacturer and shooting conditions.

AA NiMH batteries (rechargeable batteries)

Olympus NiMH batteries are rechargeable and economical. For details, refer to the instruction manual for your charger.

- **The following types of batteries cannot be used.**
Lithium battery pack (CR-V3)/AA (R6) manganese (zinc-carbon) batteries/AA (R6) oxyride batteries/AA (R6) lithium batteries
- Power consumption by the camera varies depending on which functions are used.
- Power is consumed continuously during the conditions described below causing batteries to become exhausted quickly.
 - The zoom is used repeatedly.
 - The shutter button is pressed halfway repeatedly in shooting mode, activating the auto focus and digital image stabilization.
 - Set [FULLTIME AF] to [ON].
 - The monitor is left on for an extended period of time.
 - The camera is connected to a computer or printer.
- Battery life varies depending on the type of battery, manufacturer, shooting conditions, etc. Similarly, the camera may turn off without displaying the battery level warning or may display the battery level warning more quickly.

Using a dedicated external flash

Using an Olympus FL series dedicated external flash enables you to take advantage of a wider variety of flash shooting techniques. A dedicated external flash automatically detects the flash mode and exposure settings of the camera, in the same way as the built-in flash. An external flash specified for use with this camera can be attached to the hot shoe on the top of the camera or used in combination with an FL-BK01 flash bracket (optional) and FL-CB02 bracket cable (optional).

1 Slide the hot shoe cover off in the direction of the arrow and attach the external flash.

- For instructions on how to attach the external flash, refer to the manual provided with the flash.
- Keep the hot shoe cover in a safe place to avoid losing it, and put it back on the camera after removing the external flash.

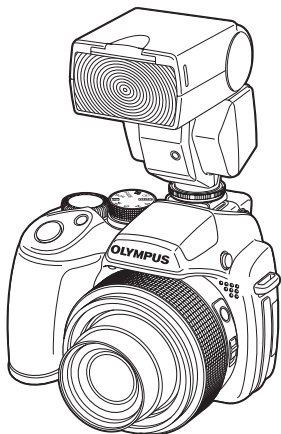
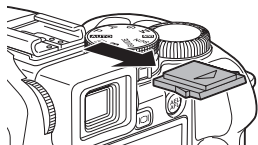

2 Turn the external flash on.

- Set the flash control mode of the flash to TTL-AUTO.
- Be sure to attach the flash to the camera before turning the flash on.

3 Press repeatedly to set the flash mode.

-  "  button Flash shooting" (P.23)

Note

- The Olympus FL-40 external flash cannot be used.
- You cannot use the built-in flash when an external flash is attached to the hot shoe.
- When using an external flash, the power turns off automatically when a certain amount of time has passed. For more details, refer to the instruction manual provided with the flash.

Using commercially available external flashes

You can use any commercial external flash that can be connected to the hot shoe. You cannot use the camera to adjust the amount of light emitted from a commercially available external flash other than the Olympus FL series.

 "Compatible external flashes" (P.83)

1 Attach the external flash to the hot shoe and connect it to the camera.

- For instructions on how to attach the external flash, refer to the manual provided with the flash.

2 Set the shutter speed and aperture value

 "M Changing the aperture value and shutter speed for shooting pictures" (P.17)

- A slow shutter speed may produce blurred images. To use the flash to best effect, you are recommended to set the shutter speed to between 1/200 and 1/300 sec.

3 Turn the external flash on.

- Be sure to attach the flash to the camera before turning the flash on.

4 Set the flash intensity control on the external flash to AUTO and set the ISO sensitivity and aperture value of the external flash to match the camera ISO sensitivity and aperture value.

- For instructions on how to select the flash control mode of the external flash, refer to the manual provided with the flash.

Note

- The flash mode set on the camera is not applied to a commercial external flash. The flash will fire even when the flash mode is set to  (flash off) on the camera.
- Check whether your external flash is synchronized with the camera before using it.

Compatible external flashes

Be sure to check the following items before using a commercial external flash.

- (1) Exposures when using an external flash require that adjustments are made on the external flash. If an external flash is used in auto mode, use a flash that can be adjusted to match the f-number and ISO sensitivity settings on the camera.
- (2) Even if the auto f-number and ISO sensitivity settings on the external flash correspond with those on the camera, the correct exposure may not be obtained depending on the shooting conditions. In such a case, adjust the auto f-number or ISO value on the external flash or calculate the distance in manual mode.
- (3) Use an external flash with an illumination angle that covers the angle of view of the lens. However, when shooting at short range in wide mode, the bottom of the screen may be cut off. It is advisable to use an external flash equipped with a wide adapter that provides broad light distribution.
- (4) Use an external flash with a flash time at full emission of 1/200 seconds or less. If the flash time is longer, not all the light may contribute to exposure.
- (5) **Use of an external flash unit with communication capability or its accessory, other than the Olympus FL series, may not only impair normal functioning, but may also cause malfunction.**

Shooting with the Olympus wireless RC flash system

Wireless flash shooting is possible with the Olympus wireless RC flash system. With this wireless flash system, you can take pictures using multiple wireless flashes. The built-in flash is used to communicate between the camera and the external flashes.

For details on using the wireless flash, see the manual of the external flash.

Wireless flash setup range

Position the wireless flash so that the wireless sensor faces the camera. The setup range guidelines are as shown below. The range changes according to the surrounding environment.

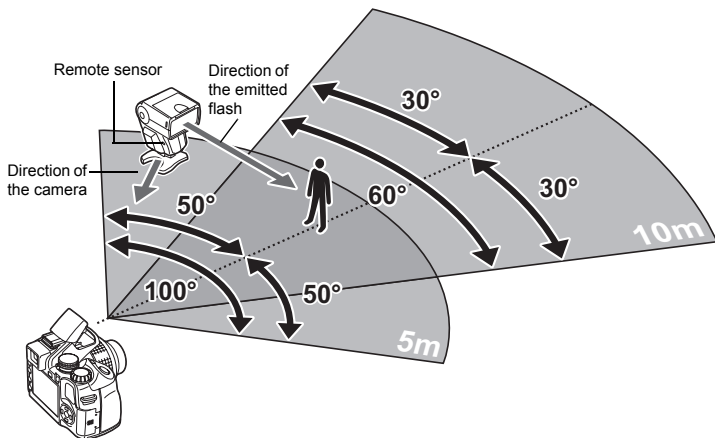

- 1** Position the flash while referring to the “Wireless flash setup range”, and turn on the flash.
- 2** Press the MODE button on the flash to set it to RC mode, and set the channel and group of the flash. Set the group to A (the flash will not operate if B or C is selected).
- 3** Select [⚡RC] from [≡FLASH] on the camera, and then set [CH1] - [CH4] to the same channel as the flash.
👉 “≡FLASH Setting to use an external flash” (P.43)
- 4** Press ⚡UP to raise the built-in flash.
- 5** Select a flash mode.
 - Red-eye reduction flash is not possible in RC mode.
- 6** After shooting preparations are completed, take some test shots to check the flash operation and images.
- 7** Begin shooting while checking the charging completed indications of the camera and flash.

! Note

- Although there is no limit to the number of wireless flashes you can use, it is recommended that no more than three flashes be used to prevent flash malfunction due to mutual interference.
- In RC mode, the built-in flash is used to control the wireless flash. The built-in flash cannot be used for flash shooting in this mode.
- For 2nd curtain synchronization, set the shutter speed to within 4 seconds. Wireless flash shooting may not operate properly when using a slower shutter speed.

Useful use of the accessories

The card

Pictures can be recorded on the optional card.

The internal memory and card are the camera's media for recording pictures, similar to film in a film camera.

Pictures recorded to the internal memory or card can be easily erased on the camera or processed using a computer.

Unlike portable storage media, the internal memory cannot be removed or exchanged.

The number of recordable pictures can be increased by using a card with a larger capacity.

- ① Index area
You can use this space to note down the contents of the card.

- ② Contact area
The part where the data transferred from the camera enters the card. Do not touch this part with your hands.

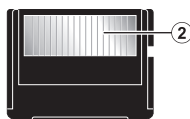

Compatible cards

xD-Picture Card (16 MB - 2 GB) (TypeH/M, Standard)

Using the internal memory or card

You can confirm on the monitor whether the internal memory or card is being used during shooting and playback operations.

Shooting mode



Memory indicator

 When using the internal memory

No icon: When using a card

Playback mode



! Note

- Do not open the battery compartment cover and card cover while the card access lamp is blinking as data reading and writing is in progress. Doing so may damage the data in the internal memory or the card and render the internal memory or card unusable.

AC adapter

An AC adapter is useful for time-consuming tasks such as image downloads to a computer or when running a slideshow for a long period of time.
Do not use any other AC adapter with this camera.

Note

- Do not remove or load the battery or connect or disconnect the AC adapter or the multi-adapter while the camera is turned on. Doing so could affect the camera's internal settings or functions.
- Be sure to read the instruction manual for the AC adapter.

Using your AC adapter abroad

- The AC adapter can be used in most home electrical sources within the range of 100 V to 240 V AC (50/60Hz) around the world. However, depending on the country or area you are in, the AC wall outlet may be shaped differently and the AC adapter may require a plug adapter to match the wall outlet. For details, ask at your local electrical shop or travel agent.
- Do not use travel voltage converters as they could damage your AC adapter.

SAFETY PRECAUTIONS

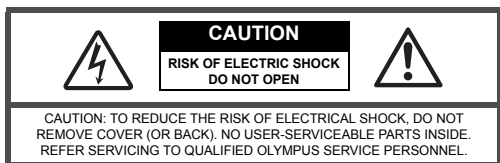

An exclamation mark enclosed in a triangle alerts you to important operating and maintenance instructions in the documentation provided with the product.



DANGER

If the product is used without observing the information given under this symbol, serious injury or death may result.



WARNING

If the product is used without observing the information given under this symbol, injury or death may result.



CAUTION

If the product is used without observing the information given under this symbol, minor personal injury, damage to the equipment, or loss of valuable data may result.

WARNING!

TO AVOID THE RISK OF FIRE OR ELECTRICAL SHOCK, NEVER DISASSEMBLE, EXPOSE THIS PRODUCT TO WATER OR OPERATE IN A HIGH HUMIDITY ENVIRONMENT.

General Precautions

Read All Instructions — Before you use the product, read all operating instructions. Save all manuals and documentation for future reference.

Cleaning — Always unplug this product from the wall outlet before cleaning. Use only a damp cloth for cleaning. Never use any type of liquid or aerosol cleaner, or any type of organic solvent to clean this product.

Attachments — For your safety, and to avoid damaging the product, use only accessories recommended by Olympus.

Water and Moisture — For precautions on products with weatherproof designs, read the weatherproofing sections.

Location — To avoid damage to the product, mount the product securely on a stable tripod, stand, or bracket.

Power Source — Connect this product only to the power source described on the product label.

Lightning — If a lightning storm occurs while using an AC adapter, remove it from the wall outlet immediately.

Foreign Objects — To avoid personal injury, never insert a metal object into the product.

Heat — Never use or store this product near any heat source such as a radiator, heat register, stove, or any type of equipment or appliance that generates heat, including stereo amplifiers.

Handling the Camera



WARNING

- **Do not use the camera near flammable or explosive gases.**
- **Do not use the flash and LED on people (infants, small children, etc.) at close range.**
 - You must be at least 1 m (3 ft.) away from the faces of your subjects. Firing the flash too close to the subject's eyes could cause a momentary loss of vision.
- **Keep young children and infants away from the camera.**
 - Always use and store the camera out of the reach of young children and infants to prevent the following dangerous situations which could cause serious injury:
 - Becoming entangled in the camera strap, causing strangulation.
 - Accidentally swallowing the battery, cards or other small parts.
 - Accidentally firing the flash into their own eyes or those of another child.
 - Accidentally being injured by the moving parts of the camera.
- **Do not look at the sun or strong lights with the camera.**
- **Do not use or store the camera in dusty or humid places.**
- **Do not cover the flash with a hand while firing.**



CAUTION

- **Stop using the camera immediately if you notice any unusual odors, noise, or smoke around it.**
 - Never remove the batteries with bare hands, which may cause a fire or burn your hands.
- **Never hold or operate the camera with wet hands.**
- **Do not leave the camera in places where it may be subject to extremely high temperatures.**
 - Doing so may cause parts to deteriorate and, in some circumstances, cause the camera to catch fire. Do not use the charger or AC adapter if it is covered (such as a blanket). This could cause overheating, resulting in fire.
- **Handle the camera with care to avoid getting a low-temperature burn.**
 - When the camera contains metal parts, overheating can result in a low-temperature burn. Pay attention to the following:
 - When used for a long period, the camera will get hot. If you hold on to the camera in this state, a low-temperature burn may be caused.
 - In places subject to extremely cold temperatures, the temperature of the camera's body may be lower than the environmental temperature. If possible, wear gloves when handling the camera in cold temperatures.
- **Be careful with the strap.**
 - Be careful with the strap when you carry the camera. It could easily catch on stray objects - and cause serious damage.

Battery Handling Precautions

Follow these important guidelines to prevent batteries from leaking, overheating, burning, exploding, or causing electrical shocks or burns.

DANGER

- Use only the Olympus brand NiMH batteries and proper fitting charger.
- Never heat or incinerate batteries.
- Take precautions when carrying or storing batteries to prevent them from coming into contact with any metal objects such as jewelry, pins, fasteners, etc.
- Never store batteries where they will be exposed to direct sunlight, or subjected to high temperatures in a hot vehicle, near a heat source, etc.
- To prevent causing battery leaks or damaging their terminals, carefully follow all instructions regarding the use of batteries. Never attempt to disassemble a battery or modify it in any way, solder, etc.
- If battery fluid gets into your eyes, flush your eyes immediately with clear, cold running water and seek medical attention immediately.
- Always store batteries out of the reach of small children. If a child accidentally swallows a battery, seek medical attention immediately.

WARNING

- Keep batteries dry at all times.
- To prevent batteries from leaking, overheating, or causing a fire or explosion, use only batteries recommended for use with this product.
- Never mix batteries (old and new batteries, charged and uncharged batteries, batteries of different manufacture or capacity, etc.).
- Never attempt to charge alkaline, lithium or CR-V3 lithium battery packs.
- Insert the battery carefully as described in the operating instructions.
- Do not use batteries if their body is not covered by the insulating sheet or if the sheet is torn, as this may cause fluid leaks, fire, or injury.

CAUTION

- Do not remove batteries immediately after using the camera. Batteries may become hot during prolonged use.
- Always unload the battery from the camera before storing the camera for a long period.

- **The following AA (R6) batteries cannot be used.**

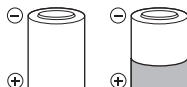

Batteries whose bodies are only partially or not at all covered by an insulating sheet.



Batteries whose - terminals are raised, but not covered by an insulating sheet.

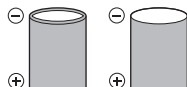

Batteries whose terminals are flat and not completely covered by an insulating sheet. (Such batteries cannot be used even if the - terminals are partially covered.)

- If NiMH batteries are not charged within the specified time, stop charging them and do not use them.
- Do not use a battery if it is cracked or broken.
- If a battery leaks, becomes discolored or deformed, or becomes abnormal in any other way during operation, stop using the camera.
- If a battery leaks fluid onto your clothing or skin, remove the clothing and flush the affected area with clean, running cold water immediately. If the fluid burns your skin, seek medical attention immediately.
- Never subject batteries to strong shocks or continuous vibration.

Caution for Usage Environment

- To protect the high-precision technology contained in this product, never leave the camera in the places listed below, no matter if in use or storage:
 - Places where temperatures and/or humidity are high or go through extreme changes. Direct sunlight, beaches, locked cars, or near other heat sources (stove, radiator, etc.) or humidifiers.
 - In sandy or dusty environments.
 - Near flammable items or explosives.
 - In wet places, such as bathrooms or in the rain. When using products with weatherproof designs, read their manuals as well.
 - In places prone to strong vibrations.
- Never drop the camera or subject it to severe shocks or vibrations.
- When mounted on a tripod, adjust the position of the camera with the tripod head. Do not twist the camera.
- Do not touch electric contacts on cameras.
- Do not leave the camera pointed directly at the sun. This may cause lens or shutter curtain damage, color failure, ghosting on the CCD, or may possibly cause fires.
- Do not push or pull severely on the lens.
- Before storing the camera for a long period, remove the batteries. Select a cool, dry location for storage to prevent condensation or mold from forming inside the camera. After storage, test the camera by turning it on and pressing the shutter button to make sure that it is operating normally.
- Always observe the operating environment restrictions described in the camera's manual.

Battery Handling Precautions

- Olympus NiMH batteries (included in some areas) are intended for use only with Olympus digital cameras. Never use these batteries with any other device.
- Always charge NiMH batteries (included in some areas) before using them for the first time, or if they have not been used for a long period.
- Always charge sets of batteries (included in some areas) (2 or 4) together.
- Do not use alkaline batteries unless it is absolutely necessary. In some cases, alkaline batteries may have a shorter service life than NiMH. Alkaline battery performance is limited, especially at low temperatures. The use of NiMH batteries is recommended.
- AA manganese (Zinc-Carbon) batteries cannot be used with this camera.
- When operating the camera with battery power at low temperatures, try to keep the camera and spare batteries as warm as possible. Batteries which run down at low temperatures may be restored after they are warmed at room temperature.
- Recommended temperature ranges for NiMH batteries:
 - Operation0°C to 40°C (32°F to 104°F)
 - Charge0°C to 40°C (32°F to 104°F)
 - Storage.....-20°C to 30°C (-4°F to 86°F)
- Using, charging, or storing the batteries outside these ranges could shorten battery life or affect battery performance. Always unload the batteries from the camera before storing the camera for a long period.
- Before using NiMH or NiCd batteries, always read the provided instructions.
- The number of pictures you can take may vary depending on the shooting conditions or batteries.
- Before going on a long trip, and especially before traveling abroad, purchase an ample supply of extra batteries. The recommended batteries may be difficult to obtain while traveling.
- Please recycle batteries to help save our planet's resources. When you throw away dead batteries, be sure to cover their terminals and always observe local laws and regulations.

LCD Monitor

- Do not push the monitor forcibly; otherwise the image may become vague, resulting in a playback mode failure or damage to the monitor.
- A strip of light may appear on the top/bottom of the monitor, but this is not a malfunction.
- When a subject is viewed diagonally in the camera, the edges may appear zigzagged on the monitor. This is not a malfunction; it will be less noticeable in playback mode.
- In places subject to low temperatures, the LCD monitor may take a long time to turn on or its color may change temporarily. When using the camera in extremely cold places, it is a good idea to occasionally place it in a warm place. An LCD monitor exhibiting poor performance due to low temperatures will recover in normal temperatures.
- The LCD used for the monitor is made with high-precision technology. However, black spots or bright spots of light may appear constantly on the LCD Monitor. Due to its characteristics or the angle at which you are viewing the monitor, the spot may not be uniform in color and brightness. This is not a malfunction.

Legal and Other Notices

- Olympus makes no representations or warranties regarding any damages, or benefit expected by using this unit lawfully, or any request from a third person, which are caused by the inappropriate use of this product.
- Olympus makes no representations or warranties regarding any damages or any benefit expected by using this unit lawfully which are caused by erasing picture data.

Disclaimer of Warranty

- Olympus makes no representations or warranties, either expressed or implied, by or concerning any content of these written materials or software, and in no event shall be liable for any implied warranty of merchantability or fitness for any particular purpose or for any consequential, incidental or indirect damages (including but not limited to damages for loss of business profits, business interruption and loss of business information) arising from the use or inability to use these written materials or software or equipment. Some countries do not allow the exclusion or limitation of liability for consequential or incidental damages, so the above limitations may not apply to you.
- Olympus reserves all rights to this manual.

Warning

Unauthorized photographing or use of copyrighted material may violate applicable copyright laws. Olympus assumes no responsibility for unauthorized photographing, use or other acts that infringe upon the rights of copyright owners.

Copyright Notice

All rights reserved. No part of these written materials or this software may be reproduced or used in any form or by any means, electronic or mechanical, including photocopying and recording or the use of any type of information storage and retrieval system, without the prior written permission of Olympus. No liability is assumed with respect to the use of the information contained in these written materials or software, or for damages resulting from the use of the information contained therein. Olympus reserves the right to alter the features and contents of this publication or software without obligation or advance notice.

FCC Notice

- Radio and Television Interference
- Changes or modifications not expressly approved by the manufacturer may void the user's authority to operate this equipment. This equipment has been tested and found to comply with the limits for a Class B digital device, pursuant to Part 15 of the FCC Rules. These limits are designed to provide reasonable protection against harmful interference in a residential installation.
- This equipment generates, uses, and can radiate radio frequency energy and, if not installed and used in accordance with the instructions, may cause harmful interference to radio communications.
- However, there is no guarantee that interference will not occur in a particular installation. If this equipment does cause harmful interference to radio or television reception, which can be determined by turning the equipment off and on, the user is encouraged to try to correct the interference by one or more of the following measures:
 - Adjust or relocate the receiving antenna.
 - Increase the distance between the camera and receiver.
 - Connect the equipment to an outlet on a circuit different from that to which the receiver is connected.
 - Consult your dealer or an experienced radio/TV technician for help. Only the OLYMPUS-supplied USB cable should be used to connect the camera to USB enabled personal computers (PC).

Any unauthorized changes or modifications to this equipment would void the user's authority to operate.

For customers in North and South America

For customers in USA

Declaration of Conformity

Model Number : SP-570UZ

Trade Name : OLYMPUS

Responsible Party : **OLYMPUS IMAGING AMERICA INC.**

Address : 3500 Corporate Parkway, P.O. Box 610, Center Valley,
PA 18034-0610, U.S.A.

Telephone Number : 484-896-5000

Tested To Comply With FCC Standards
FOR HOME OR OFFICE USE

This device complies with Part 15 of the FCC rules. Operation is subject to the following two conditions:

- (1) This device may not cause harmful interference.
- (2) This device must accept any interference received, including interference that may cause undesired operation.

For customers in Canada

This Class B digital apparatus meets all requirements of the Canadian Interference-Causing Equipment Regulations.

OLYMPUS WORLDWIDE LIMITED WARRANTY - IMAGING PRODUCTS

Olympus warrants that the enclosed Olympus® imaging product(s) and related Olympus® accessories (individually a "Product" and collectively the "Products") will be free from defects in materials and workmanship under normal use and service for a period of one (1) year from the date of purchase.

If any Product proves to be defective within the one-year warranty period, the customer must return the defective Product to any of Olympus Service Centers, following the procedure set forth below (See "WHAT TO DO WHEN SERVICE IS NEEDED").

Olympus, at its sole discretion, will repair, replace, or adjust the defective Product, provided that Olympus investigation and factory inspection disclose that (a) such defect developed under normal and proper use and (b) the Product is covered under this limited warranty.

Repair, replacement, or adjustment of defective Products shall be Olympus's sole obligation and the customer's sole remedy hereunder.

The customer is liable and shall pay for shipment of the Products to the Olympus Service Center. Olympus shall not be obligated to perform preventive maintenance, installation, deinstallation, or maintenance.

Olympus reserves the right to (i) use reconditioned, refurbished, and/or serviceable used parts (that meet Olympus's quality assurance standards) for warranty or any other repairs and (ii) make any internal or external design and/or feature changes on or to its products without any liability to incorporate such changes on or to the Products.

WHAT IS NOT COVERED BY THIS LIMITED WARRANTY

Excluded from this limited warranty and not warranted by Olympus in any fashion, either express, implied, or by statute, are:

- products and accessories not manufactured by Olympus and/or not bearing the "OLYMPUS" brand label (the warranty coverage for products and accessories of other manufacturers, which may be distributed by Olympus, is the responsibility of the manufacturers of such products and accessories in accordance with the terms and duration of such manufacturers' warranties);
- any Product which has been disassembled, repaired, tampered with, altered, changed, or modified by persons other than Olympus's own authorized service personnel unless repair by others is made with the written consent of Olympus;
- defects or damage to the Products resulting from wear, tear, misuse, abuse, negligence, sand, liquids, impact, improper storage, nonperformance of scheduled operator and maintenance items, battery leakage, use of non-"OLYMPUS" brand accessories, consumables, or supplies, or use of the Products in combination with non-compatible devices;
- software programs;
- supplies and consumables (including but not limited to lamps, ink, paper, film, prints, negatives, cables and batteries); and/or
- Products which do not contain a validly placed and recorded Olympus serial number, unless they are a model on which Olympus does not place and record serial numbers.

EXCEPT FOR THE LIMITED WARRANTY SET FORTH ABOVE, OLYMPUS MAKES NO AND DISCLAIMS ALL OTHER REPRESENTATIONS, GUARANTIES, CONDITIONS, AND WARRANTIES CONCERNING THE PRODUCTS, WHETHER DIRECT OR INDIRECT, EXPRESS OR IMPLIED, OR ARISING UNDER ANY STATUTE, ORDINANCE, COMMERCIAL USAGE OR OTHERWISE, INCLUDING BUT NOT LIMITED TO ANY WARRANTY OR REPRESENTATION AS TO THE SUITABILITY, DURABILITY, DESIGN, OPERATION, OR CONDITION OF THE PRODUCTS (OR ANY PART THEREOF) OR THE MERCHANTABILITY OF THE PRODUCTS OR THEIR FITNESS FOR A PARTICULAR PURPOSE, OR RELATING TO THE INFRINGEMENT OF ANY PATENT, COPYRIGHT, OR OTHER PROPRIETARY RIGHT USED OR INCLUDED THEREIN.

IF ANY IMPLIED WARRANTIES APPLY AS A MATTER OF LAW, THEY ARE LIMITED IN DURATION TO THE LENGTH OF THIS LIMITED WARRANTY.

SOME STATES MAY NOT RECOGNIZE A DISCLAIMER OR LIMITATION OF WARRANTIES AND/OR LIMITATION OF LIABILITY SO THE ABOVE DISCLAIMERS AND EXCLUSIONS MAY NOT APPLY.

THE CUSTOMER MAY ALSO HAVE DIFFERENT AND/OR ADDITIONAL RIGHTS AND REMEDIES THAT VARY FROM STATE TO STATE.

THE CUSTOMER ACKNOWLEDGES AND AGREES THAT OLYMPUS SHALL NOT BE RESPONSIBLE FOR ANY DAMAGES THAT THE CUSTOMER MAY INCUR FROM DELAYED SHIPMENT, PRODUCT FAILURE, PRODUCT DESIGN, SELECTION, OR PRODUCTION, IMAGE OR DATA LOSS OR IMPAIRMENT OR FROM ANY OTHER CAUSE, WHETHER LIABILITY IS ASSERTED IN CONTRACT, TORT (INCLUDING NEGLIGENCE AND STRICT PRODUCT LIABILITY) OR OTHERWISE. IN NO EVENT SHALL OLYMPUS BE LIABLE FOR ANY INDIRECT, INCIDENTAL, CONSEQUENTIAL OR SPECIAL DAMAGES OF ANY KIND (INCLUDING WITHOUT LIMITATION LOSS OF PROFITS OR LOSS OF USE), WHETHER OR NOT OLYMPUS SHALL BE OR SHOULD BE AWARE OF THE POSSIBILITY OF SUCH POTENTIAL LOSS OR DAMAGE.

Representations and warranties made by any person, including but not limited to dealers, representatives, salespersons, or agents of Olympus, which are inconsistent or in conflict with or in addition to the terms of this limited warranty, shall not be binding upon Olympus unless reduced to writing and approved by an expressly authorized officer of Olympus.

This limited warranty is the complete and exclusive statement of warranty which Olympus agrees to provide with respect to the Products and it shall supersede all prior and contemporaneous oral or written agreements, understandings, proposals, and communications pertaining to the subject matter hereof.

This limited warranty is exclusively for the benefit of the original customer and cannot be transferred or assigned.

WHAT TO DO WHEN SERVICE IS NEEDED

The customer must transfer any image or other data saved on a Product to another image or data storage medium and/or remove any film from the Product prior to sending the Product to Olympus for service.

IN NO EVENT SHALL OLYMPUS BE RESPONSIBLE FOR SAVING, KEEPING OR MAINTAINING ANY IMAGE OR DATA SAVED ON A PRODUCT RECEIVED BY IT FOR SERVICE, OR ON ANY FILM CONTAINED WITHIN A PRODUCT RECEIVED BY IT FOR SERVICE. NOR SHALL OLYMPUS BE RESPONSIBLE FOR ANY DAMAGES IN THE EVENT ANY IMAGE OR DATA IS LOST OR IMPAIRED WHILE SERVICE IS BEING PERFORMED (INCLUDING, WITHOUT LIMITATION, DIRECT, INDIRECT, INCIDENTAL, CONSEQUENTIAL OR SPECIAL DAMAGES, LOSS OF PROFITS OR LOSS OF USE), WHETHER OR NOT OLYMPUS SHALL BE OR SHOULD BE AWARE OF THE POSSIBILITY OF SUCH POTENTIAL LOSS OR IMPAIRMENT.

Package the Product carefully using ample padding material to prevent damage in transit and either deliver it to the Authorized Olympus Dealer that sold you the Product or ship it postage prepaid and insured to any of our Olympus Service Centers.

When returning Products for service, your package should include the following:

1. Sales receipt showing date and place of purchase.
2. Copy of this limited warranty **bearing the Product serial number corresponding to the serial number on the Product** (unless it is a model on which Olympus does not place and record serial numbers).
3. A detailed description of the problem.
4. Sample prints, negatives, digital prints (or files on disk) if available and related to the problem.

When service is completed, the Product will be returned to you postage prepaid.

WHERE TO SEND PRODUCT FOR SERVICE

See "WORLDWIDE WARRANTY" for the nearest service center.

INTERNATIONAL WARRANTY SERVICE

International warranty service is available under this warranty.

Trademarks

- IBM is a registered trademark of International Business Machines Corporation.
- Microsoft and Windows are registered trademarks of Microsoft Corporation.
- Macintosh is a trademark of Apple Inc.
- xD-Picture Card™ is a trademark.
- All other company and product names are registered trademarks and/or trademarks of their respective owners.
- The standards for camera file systems referred to in this manual are the "Design Rule for Camera File System/DCF" standards stipulated by the Japan Electronics and Information Technology Industries Association (JEITA).

SPECIFICATIONS











● Camera



















Product type	: Digital camera (for shooting and displaying)
Recording system	
Still pictures	: Digital recording, JPEG (in accordance with Design rule for Camera File system (DCF)), RAW data
Applicable standards	: Exif 2.2, Digital Print Order Format (DPOF), PRINT Image Matching III, PictBridge
Sound with still pictures	: Wave format
Movie	: AVI Motion JPEG
Memory	: Internal memory xD-Picture Card (16 MB - 2 GB) (TypeH/M, Standard)
No. of effective pixels	: 10,000,000 pixels
Image pickup device	: 1/2.33" CCD (primary color filter), 10,700,000 pixels (gross)
Lens	: Olympus lens 4.6 to 92 mm, f2.8 to 4.5 (equivalent to 26 to 520 mm on a 35 mm camera)
Photometric system	: Digital ESP metering, spot metering, center weighted metering
Shutter speed	: 15 to 1/2000 sec. (During bulb: Max. 8 minutes)
Aperture	: F2.8 to F8.0
Shooting range	: 0.1 m (3.9 in.) to ∞ (W) 1.2 m (47.2 in.) to ∞ (T) (normal/macro mode) 0.01 m (0.4 in.) to ∞ (super macro mode)
Monitor	: 2.7" TFT color LCD display, 230,000 dots
Flash charge time	: Approx. 7 sec. (for full flash discharge at room temperature using a new fully charged battery)
Connector	: DC-IN jack USB connector, A/V OUT jack (multi-connector)
Automatic calendar system	: 2000 up to 2099
Operating environment	
Temperature	: 0 °C to 40 °C (32 °F to 104 °F) (operation)/ -20 °C to 60 °C (-4 °F to 140 °F) (storage)
Humidity	: 30 % to 90 % (operation)/10 % to 90 % (storage)
Power supply	: AA alkaline / NiMH battery (four) or Olympus AC adapter
Dimensions	: 118.5 mm (W) × 84 mm (H) × 87.5 mm (D) (4.7 × 3.3 × 3.4 in.) (excluding protrusions)
Weight	: 445 g (15.7 oz) without batteries and card







Design and specifications subject to change without notice.

Index



- Camera diagram** 11
- FLASH** 43
- RC** 43, 84
- VOLUME** 53
- A**
- AC adapter 86
- Adding sound to still pictures 50
- AE LOCK **[AEL]** 23
- AEL/AFL BUTTON 23, 57
- AF 24
- AF ILLUMINAT. 42
- AF LOCK **[AFL]** 23
- AF MODE 41
- AF PREDICT **[AF]** 42
- AF sequential shooting **[AF]** 24, 40
- AF target mark 9, 21, 41
- ALARM CLOCK **[A]** 55
- ALL (PERFECT FIX) 46
- ALL ERASE 51
- ALL INDEX 60
- ALL PRINT 60
- All-frame reservation **[AF]** 62
- Aperture priority mode **A** 6, 17
- Aperture value 17
- AREA 42
- AUTO (full automatic) **AUTO** 6, 16
- AUTO (ISO) 40
- AUTO (white balance) **WB AUTO** 39
- Auto bracketing **BKT** 24, 40
- Auto focus 70
- Auto-flash 23
- AV cable 3, 56
- B**
- BACKUP 52
- Batteries 4, 81
- BEEP 53
- BGM (SLIDESHOW) 46
- BKT 24, 40
- Bracket shooting 40
- C**
- CALENDAR 47
- CALENDAR (edit) 48
- CALENDAR (playback) 47
- Calendar display 22
- CAMERA MENU 34, 39
- Card 5, 36, 52, 85
- Center-weighted metering **[C]** 41
- Close-up playback **[Q]** 22
- Cloudy day **[C]** 39
- COLOR EDIT 47
- COMBINE IN CAMERA1/2 36
- COMBINE IN PC 37
- COMPRESSION 34, 72
- CONTRAST **[C]** 44
- CONTROL PANEL 53
- Control panel 29
- Conversion lens **[C]** 45
- Cropping (DPOF) 62
- Cropping (PictBridge) 61
- Cropping **[C]** 47
- CURRENT (MY MODE SETUP) 57
- CUSTOM (MY MODE SETUP) 57
- CUSTOM BUTTON 27, 58, 78
- CUSTOM PRINT 60
- D**
- Date and time **[D]** 7, 54
- DIGITAL ZOOM 41
- DIRECT (Histogram) 57
- Direct printing 59
- DPOF 61
- DRIVE 24, 40
- DUALTIME **[D]** 55
- E**
- EASY PRINT 59
- EDIT 47, 49
- ERASE 51
- Error messages 76
- ESP 41
- EV 22
- Exposure 22
- Exposure compensation **[E]** 22
- EXPRESSION EDIT 49
- F**
- FACE DETECT 41
- FACE FOCUS 49
- FILE NAME 54, 61
- Fill-in flash **[F]** 23
- FINE **[FINE]** 34
- FINE ZOOM 41
- Flash intensity control **[F]** 42
- Flash mode **[F]** 23
- Flash off **[F]** 23
- Fluorescent lamp 1/2/3 **[F1, F2, F3]** 39
- Focus 9, 21, 69
- Focus lock 21
- Focus mode 24
- FORMAT 52
- FRAME 48
- FRAME ASSIST **[F]**, **[F]** 56
- FRAME RATE 35
- FULLTIME AF 42
- Function menu 28
- G**
- GUIDE** 6, 18

H	
HIGH ISO AUTO	40
High speed sequential shooting 1/2  	24, 40
Histogram 	26, 57, 74
I	
iESP	41
IMAGE QUALITY	34
IMAGE SIZE	34, 35, 72
IMAGE STABILIZER 	42
INDEX	49
Index display	22
INDEX PLAY	50
Information displays	26
INT/EXT	43, 82
Internal memory	85
ISO	40
J	
JPEG	34
L	
LABEL	48
LAYOUT	48
LIGHTING FIX	46
M	
m/ft	57
Macro mode 	27
MANUAL FOCUS	58
Manual mode M	6, 17
MEMORY FORMAT	52
MENU COLOR	52
MENU DISPLAY	53
Menu guide	27
METERING	41
MF	24
Monitor brightness adjustment 	54
MOVIE INDEX	49
Movie recording 	6, 18, 21
MULTI PRINT	60
MY MODE 	6, 18
MY MODE SETUP My1/2/3/4	57, 78
N	
NATURAL 	43
NOISE REDUCT. NR	44
NORMAL NORM	34
NTSC	56
Number of prints 	61
Number of storage still picture	72
O	
OLYMPUS Master	64
Olympus wireless RC flash system	84
One-touch WB 	39
Optical zoom	21

P	
PAL	56
PANORAMA	36
Panorama playback	20
PC	65
PERFECT FIX	46
PictBridge	59
PICTURE MODE	43
Picture rotation 	50
PIXEL MAPPING	54
PLAYBACK MENU	46, 50
Playback mode 	16, 19, 25
Playback on a TV	56
Playing time	19
PRE-CAPTURE 	24
PRESET (WB)	39
Press completely	9
Press halfway	9
PRINT ORDER 	60
Print settings 	61
Program mode P	6, 16
Protect 	50
PW ON SETUP	52
R	
RAW	34, 47, 72
RAW DATA EDIT	47
REC VIEW	53
Recording length of movies	73
Recording sound with movies 	45
Recording sound with still picture 	43
Red-eye fill-in flash 	23
REDEYE FIX	46
Red-eye reduction flash 	23
RESET	35
RESET (MY MODE SETUP)	57
Resizing 	47
S	
SATURATION RGB	44
SCN (Scene)	6, 18, 37
SEL. IMAGE	51
Selecting a language 	52
Self-timer 	28
Sequential Pictures Auto Playback	20
Sequential Playback	20
Sequential shooting 	24, 40
SETUP	52
Shadow Adjustment Technology 	25
SHARPNESS 	44
Shooting guide GUIDE	6, 18
Shooting mode	6, 16
Shutter priority mode S	6, 17
SHUTTER SOUND	53
Shutter speed	17
SILENT MODE 	45
Single-frame reservation 	62
Single-frame shooting 	24, 40
SLAVE	43
SLEEP	58

Sleep mode	58, 68
SLIDESHOW	46
Slow synchronization  	23, 24
Slow synchronization/Red-eye reduction flash 	23
SOUND SETTINGS	53
SPOT (AF MODE)	41
Spot metering 	41
STANDARD	59
Strap	3
Sunny day 	39
Super macro mode 	27

T

TIMELAPSE 	45
Top menu	25, 32
Total recording time	19
Tungsten light 	39
TYPE (SLIDESHOW)	46



U

USB cable	3, 59, 64, 65, 67
-----------------	-------------------

V

VIDEO OUT	56
VIVID 	43

W

Warning sound 	53
WB	39
White balance compensation 	43

X

xD-Picture Card	5, 36, 85
-----------------------	-----------

Z

Zoom	21, 41
------------	--------

MEMO

MEMO



<http://www.olympusamerica.com/>

OLYMPUS IMAGING AMERICA INC.

3500 Corporate Parkway, P.O. Box 610, Center Valley, PA 18034-0610, U.S.A. Tel. 484-896-5000

Technical Support (USA)

24/7 online automated help: <http://www.olympusamerica.com/support>

Phone customer support: Tel. 1-888-553-4448 (Toll-free)

Our phone customer support is available from 8 am to 10 pm (Monday to Friday) ET

<http://olympusamerica.com/contactus>

Olympus software updates can be obtained at: <http://www.olympusamerica.com/digital>

To find the nearest Service Centers, please visit: <http://www.olympusamerica.com/digital>, and click on the Worldwide Warranty icon at the bottom of the page.

Service Centers

U.S.A.:

California Olympus Imaging America Inc.
10805 Holder Street Suite 170
Cypress, CA 90630-5145
Tel: (888) 553-4448

New York Olympus Imaging America Inc.
400 Rabro Drive
Hauppauge, NY 11788-4258
Tel: (888) 553-4448

Canada: Olympus Canada Inc.
Consumer Products Group
151 Telson Road
Markham, Ontario Canada L3R 1E7
Tel. (888)553-4448

Mexico: Olympus Imaging de Mexico S.A. de C.V.
WTC Mexico,
Montecito No.38 - Lobby - Office 3
Col. Napoles, Mexico D.F. 03810
Tel. (01800)800-2128
E-mail: oimx@olympus.com

Argentina: Jesus Labrador
Paraguay 755 PB, C1057AAI - Buenos Aires
Tel: (011) 4313-3174 Fax: (011) 4312-5239
E-Mail: olympus@jesuslabrador.com.ar
Jesus Labrador
Bartolome Mitrrte 860
C1036AAP - Buenos Aires
Tel: (011) 4331-1227 Fax: (011) 4331-1247
E-mail: service@basr.com.ar

Brazil:

Olympus Optical do Brasil Ltda.
Rua do Rocio 430 - 2 andar - Vila Olimpia
CEP 04552-906 - São Paulo - Brasil
Tel: +55 11 3046-6427
Fax: +55 11 3046-6412
E-mail: obl-cameras@olympus.com

Chile:

REIFSCHEIDER S.A.
Camino El Conquistador del Monte 5024
Huechuraba, Santiago
Tel: 56-2-6781200 Fax: 56-2-6781202
E-mail : olympus@reifschneider.cl,
serviciotecnico@reifschneider.cl

Colombia:

CV Tronica LTDA
Calle 68 No 12-57, Bogota
Tel: (0571)235-7260/348-1573
Fax: (0571) 348-1574
E-mail: servicio@cvtronica.com
CV Tronica LTDA
Cra 9 No 23-49 Local 215 C.C Intercentro, Bogota
Tel: (0571)284-4365
CV Tronica LTDA
Av. Cra 15 No 105A-22 Piso 2 Local 5, Bogota
Tel: (0571)637-3540

Panama:

FOTOSER
Edif. El Paical, Oficina No3, P.A.
Urb. Herbruger, Transistmica
(Detras del S/M Riba Smith),
Tel/Fax: (507) 261-0436
E-mail: rearanda@rocketmail.com

Uruguay:

Fotocamara S.R.L.
Rondeau 1470 Montevideo
Tel: (02) 900-2004 Fax: (02) 900-8430
E-mail: FOTOCAM@ADINET.COM.UY

Venezuela:

Micron C.A.
4ta. transversal Urb. Horizonte,
Edificio América, Mezanine, Caracas 1070-A
Tel: (0212) 238-3526 Fax: (0212) 239-8598
E-mail: serviciotecnico@micron.com.ve