

# **OLYMPUS<sup>®</sup>**

DIGITAL CAMERA

# *SP-590UZ*

## Instruction Manual

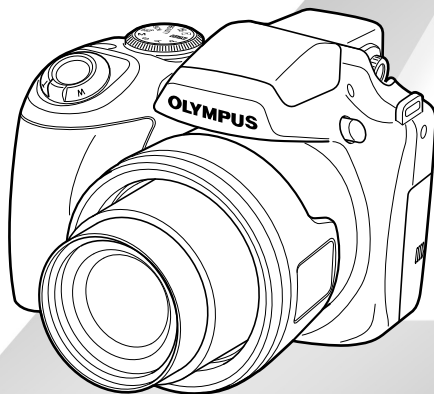

- Thank you for purchasing an Olympus digital camera. Before you start to use your new camera, please read these instructions carefully to enjoy optimum performance and a longer service life. Keep this manual in a safe place for future reference.
- We recommend that you take test shots to get accustomed to your camera before taking important photographs.
- In the interest of continually improving products, Olympus reserves the right to update or modify information contained in this manual.
- The screen and camera illustrations shown in this manual were produced during the development stages and may differ from the actual product.

## Step 1

### Checking the contents of the box



Digital camera



Lens cap and lens cap strap



USB cable



AV cable



Camera strap



Four AA batteries



OLYMPUS Master 2  
CD-ROM



microSD Attachment

Other accessories not shown: Instruction Manual, warranty card  
Contents may vary depending on purchase location.

## Step 2

### Preparing the Camera

"Preparing the Camera" (p. 10)

## Step 3

### Shooting and Playing Back Images

"Shooting, Playback and Erasing" (p. 14)

## Step 4

### How to Use the Camera

"Three Types of Setting Operations" (p. 3)

## Step 5

### Printing

Direct printing (PictBridge) (p. 58)  
Print reservations (DPOF) (p. 61)

## Contents

- **Names of Parts** .....6
- **Preparing the Camera** .....10
- **Shooting, Playback and Erasing** .....14
- **Using Shooting Modes** .....17
- **Using Shooting Functions** .....21
- **Using Playback Features** .....27
- **Menus for Shooting Functions** .....29
- **Menus for Playback, Editing and Printing Functions** .....44
- **Menus for Other Camera Settings** .....50
- **Printing** .....58
- **Using OLYMPUS Master 2** .....64
- **Usage Tips** .....66
- **Appendix** .....71
- **Index** .....83

## Three Types of Setting Operations

### Using the Menu

Various camera settings can be accessed through the menu, including functions used during shooting and playback and the date/time and screen display.

- There may be unavailable menus depending on the other related settings or the position of the mode dial.

- Set the mode dial to one of the selections.

- The  symbol in “Menu Settings” (p. 29 to 43) indicates available shooting modes.







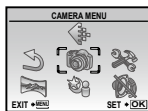

- Press the **MENU** button.

- This example shows how to set the [DIGITAL ZOOM].



Shooting mode top menu

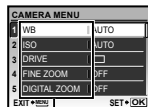

- Use     to select the desired menu, and press the  button.

- Pressing and holding the  button displays an explanation (menu guide) of the option selected.

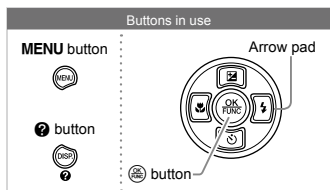

Submenu 1





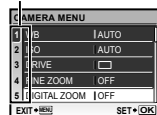

- Use   to select the desired submenu 1, and press the  button.

Page tab

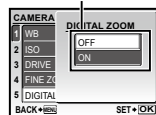



Submenu 2



- To quickly jump to the desired submenu, press  to highlight the page tab, and then use   to move the page tab. Press  to return to the submenu 1.

- Some menu include submenus that appear by pressing the  button.

- Use   to select the submenu 2, and press the  button.

- Once a setting is made, the display returns to the previous screen.

- There may be additional operations. “Menu Settings” (p. 29 to 57)

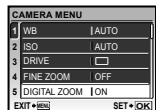

- Press the **MENU** button to complete the setting.

## Using the Direct Buttons

Frequently used shooting functions can be accessed using the direct buttons.

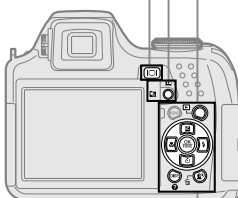
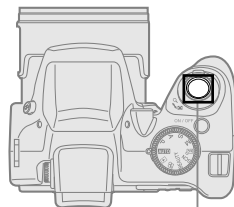
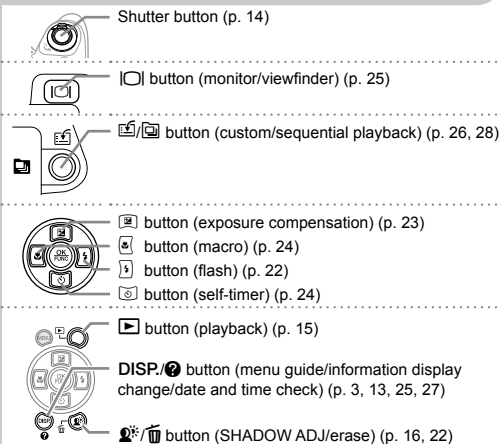

## Using the FUNC menu (p. 26)

Frequently used shooting menu functions can be set with less steps using the FUNC menu.

Ⓜ button (p. 26)

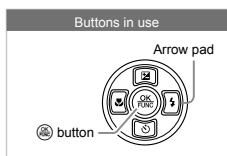

## Menu Index

### Menus for Shooting Functions

When the mode dial is set to a shooting mode position (**AUTO** **P** **A** **S** **M** **SCN** **BEAUTY** **Ⓜ**), settings can be adjusted.

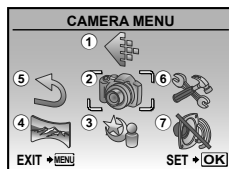

Shooting mode top menu

①	🔍 IMAGE QUALITY..... p. 29	PICTURE MODE..... p. 37	SOUND SETTINGS..... p. 51
②	📷 CAMERA MENU	SHARPNESS..... p. 37	REC VIEW..... p. 52
	WB..... p. 30	CONTRAST..... p. 38	MENU DISPLAY..... p. 52
	ISO..... p. 31	SATURATION..... p. 38	LIVE VIEW BOOST..... p. 52
	DRIVE..... p. 32	NOISE REDUCT..... p. 38	FILE NAME..... p. 53
	FINE ZOOM..... p. 33	TIMELAPSE..... p. 39	PIXEL MAPPING..... p. 53
	DIGITAL ZOOM..... p. 33	📷 (Conversion lens) .. p. 39	📺 (Monitor)..... p. 54
	METERING..... p. 33	🎤 (Movie REC)..... p. 39	🕒 (Date/time)..... p. 54
	AF MODE..... p. 34	③ 🎤 <b>SCN</b> ..... p. 40	DUALTIME..... p. 54
	FOCUS MODE..... p. 34	④ 📷 PANORAMA..... p. 42	PIC ORIENTATION..... p. 54
	FULLTIME AF..... p. 35	⑤ 🔄 RESET..... p. 43	VIDEO OUT..... p. 55
	AF PREDICT..... p. 35	⑥ 🎤 SETUP	HDMI..... p. 56
	AF ILLUMINAT..... p. 35	MEMORY FORMAT/	📊 (Histogram)..... p. 56
	IMAGE STABILIZER... p. 35	FORMAT..... p. 50	MY MODE SETUP..... p. 56
	🔆 (Flash intensity).... p. 36	BACKUP..... p. 50	m/ft..... p. 57
	🔆 FLASH..... p. 36	🗣️ (Language)..... p. 50	CUSTOM BUTTON..... p. 57
	🎤 (Still picture REC)... p. 37	PW ON SETUP..... p. 51	SLEEP..... p. 57
	WB72 (WB fine adjust). p. 37	MENU COLOR..... p. 51	⑦ 🎤 SILENT MODE..... p. 57

Menus for Playback, Editing and Printing Functions

When the mode dial is set to the  position, settings can be adjusted.

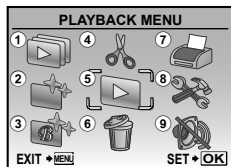

Playback mode top menu

①	📺 SLIDESHOW..... p. 44	INDEX..... p. 47	⑦ 🎤 PRINT ORDER..... p. 49
②	👉 PERFECT FIX..... p. 44	EDIT..... p. 47	⑧ 🎤 SETUP*
③	👉 BEAUTY FIX..... p. 45	MOVIE INDEX..... p. 47	* Same as "Menu for shooting functions"
④	✂️ EDIT	⑤ 📺 PLAYBACK MENU	⑨ 🎤 SILENT MODE..... p. 57
	📏 (Resize)..... p. 45	🔒 (Protect)..... p. 48	
	📏 (Crop)..... p. 45	🔄 (Rotate)..... p. 48	
	COLOR EDIT..... p. 46	🎤 (Post REC)..... p. 48	
	CALENDAR..... p. 46	INDEX PLAY..... p. 48	
	FACE FOCUS..... p. 46	⑥ 🗑️ ERASE..... p. 49	



# Names of Parts

## Camera unit

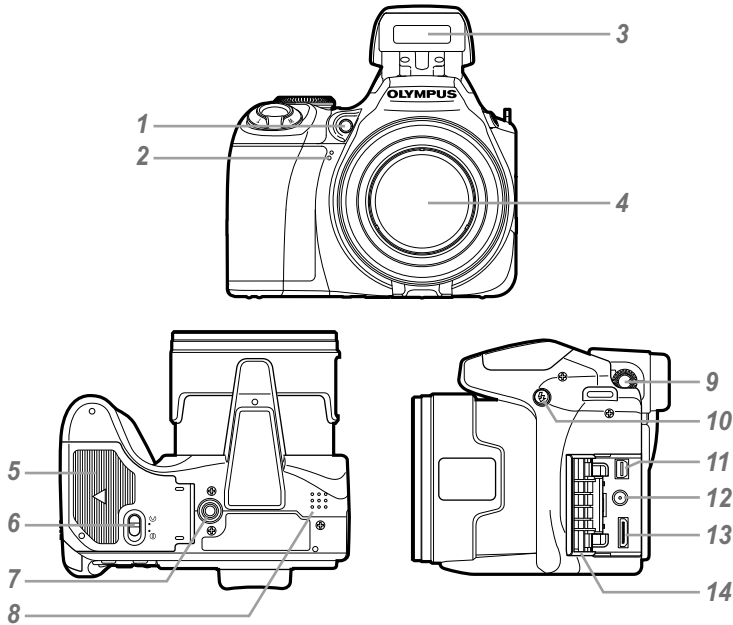

- 1 Self-timer lamp/  
AF illuminator ..... p. 24, 35
- 2 Microphone ..... p. 48
- 3 Flash ..... p. 22
- 4 Lens
- 5 Battery compartment cover ..... p. 10
- 6 Battery compartment lock ..... p. 10
- 7 Tripod socket

- 8 Speaker
- 9 Diopter adjustment dial ..... p. 25
- 10  button (flash flip-up) ..... p. 22
- 11 Multi-connector ..... p. 55, 58, 64
- 12 DC-IN jack ..... p. 72
- 13 HDMI mini connector ..... p. 55
- 14 Connector cover ..... p. 55, 58, 64

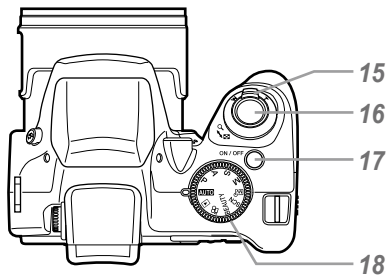
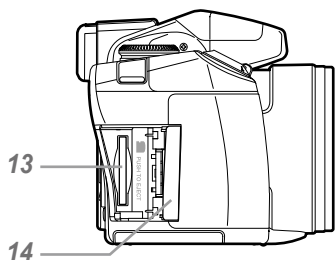
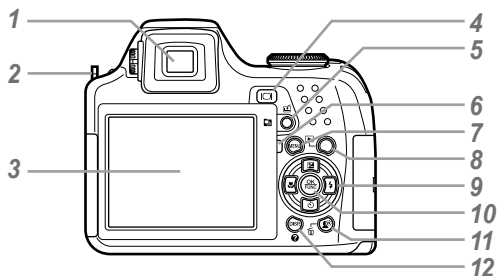

- 1 Viewfinder ..... p. 25
- 2 Strap eyelet..... p. 10
- 3 Monitor ..... p. 8, 14, 54
- 4 button (monitor/viewfinder)... p. 25
- 5 / button (custom/sequential playback) ..... p. 26, 28
- 6 Card access lamp ..... p. 73
- 7 **MENU** button..... p. 3
- 8 button (playback) ..... p. 15
- 9 Arrow pad ..... p. 12
  - button  
(exposure compensation).... p. 23
  - button (macro) ..... p. 24
  - button (self-timer) ..... p. 24
  - button (flash)..... p. 22

- 10 button (OK/FUNC)..... p. 26
- 11 button  
(SHADOW ADJ/erase)..... p. 16, 22
- 12 **DISP./** button  
(menu guide/information display  
change/date and time check)  
.....p. 3, 13, 25, 27
- 13 Card slot ..... p. 11
- 14 Card cover ..... p. 11
- 15 Zoom lever ..... p. 21, 27
- 16 Shutter button ..... p. 14, 20
- 17 **ON/OFF** button ..... p. 11, 12, 14
- 18 Mode dial ..... p. 3, 14

Shooting mode display

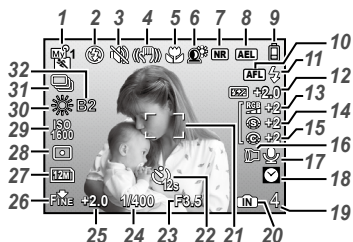

Still image

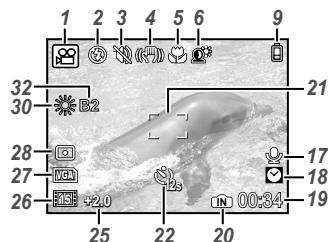

Movie

- |           |   |           |           |   |               |
|-----------|---|-----------|-----------|---|---------------|
| <b>1</b>  | Shooting mode.....                                      | p. 17, 29 | <b>16</b> | Conversion lens.....  | p. 39         |
| <b>2</b>  | Flash mode.....   | p. 23     | <b>17</b> | Sound record.....   | p. 37, 39     |
| <b>3</b>  | Silent mode.....  | p. 57     | <b>18</b> | Dual time.....  | p. 54         |
| <b>4</b>  | Digital image stabilization.....                        | p. 35     | <b>19</b> | Number of storable still pictures/<br>remaining recording time... p. 15, 20, 73 |               |
| <b>5</b>  | Macro/super macro mode.....                             | p. 24     | <b>20</b> | Current memory.....   | p. 72         |
| <b>6</b>  | SHADOW ADJ.....   | p. 22     | <b>21</b> | AF target mark.....   | p. 14, 26, 34 |
| <b>7</b>  | Noise reduction.....                                    | p. 38     | <b>22</b> | Self-timer.....   | p. 24         |
| <b>8</b>  | AE lock.....  | p. 57     | <b>23</b> | Aperture value.....   | p. 17         |
| <b>9</b>  | Battery check.....                                      | p. 10, 67 | <b>24</b> | Shutter speed.....  | p. 17         |
| <b>10</b> | AF lock (AFL).....                                      | p. 57     | <b>25</b> | Exposure compensation.....  | p. 23         |
|           | Manual focus (MF).....                                  | p. 34     | <b>26</b> | Compression/frame rate.....   | p. 29         |
|           | AF predict (AF).....                                    | p. 35     | <b>27</b> | Image size.....   | p. 29         |
| <b>11</b> | Flash standby/camera shake<br>warning/flash charge..... | p. 66     | <b>28</b> | Metering.....   | p. 33         |
| <b>12</b> | Flash intensity.....                                    | p. 36     | <b>29</b> | ISO.....  | p. 31         |
| <b>13</b> | Saturation.....   | p. 38     | <b>30</b> | White balance.....  | p. 30         |
| <b>14</b> | Sharpness.....  | p. 37     | <b>31</b> | Drive.....  | p. 32         |
| <b>15</b> | Contrast.....   | p. 38     | <b>32</b> | White balance fine adjust.....  | p. 37         |



## Playback mode display

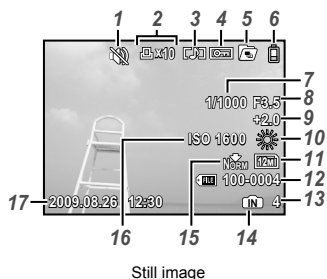

Still image



Movie

- |   |   |
|---|---|
| <p><b>1</b> Silent mode..... p. 57</p> <p><b>2</b> Print reservation/<br/>number of prints..... p. 61</p> <p><b>3</b> Sound record ..... p. 37, 39</p> <p><b>4</b> Protect ..... p. 48</p> <p><b>5</b> Sequential playback<br/>(index/slideshow)..... p. 28</p> <p><b>6</b> Battery check..... p. 10, 67</p> <p><b>7</b> Shutter speed ..... p. 17</p> <p><b>8</b> Aperture value ..... p. 17</p> | <p><b>9</b> Exposure compensation ..... p. 23</p> <p><b>10</b> White balance..... p. 30</p> <p><b>11</b> Image size ..... p. 29</p> <p><b>12</b> File number..... p. 53</p> <p><b>13</b> Frame number<br/>Playing time/total recording time.. p. 16</p> <p><b>14</b> Current memory..... p. 72</p> <p><b>15</b> Compression/frame rate ..... p. 29</p> <p><b>16</b> ISO..... p. 31</p> <p><b>17</b> Date and time ..... p. 12, 54</p> |
|---|---|



# Preparing the Camera

## Attaching the camera strap and lens cap

1

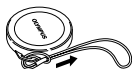

2



3

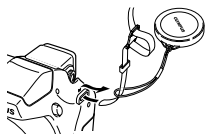

4



- Attach the strap to the other eyelet in the same manner.

5



- Pull the strap tight so that it does not come loose.

## Loading the batteries

1

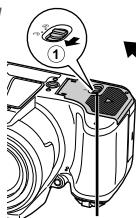

2

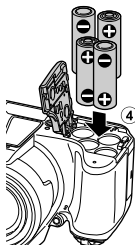

3

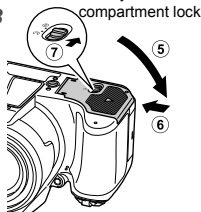

- Slide the battery compartment lock from ☺ to ☹ and ensure that the battery compartment cover is securely locked (7). Failure to do so may cause the battery compartment cover to open during shooting and the batteries to fall out, resulting in loss of image data.

- For the types of batteries that can be used, see "Battery handling precautions" (p. 71). If using rechargeable batteries, charge the batteries.

- Turn off the camera before opening or closing the battery compartment cover.

## When to replace the batteries

Replace the batteries when the error message shown below appears.

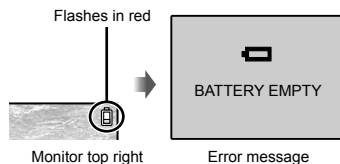

## Loading the xD-Picture Card™ (sold separately) into the camera

This camera allows the user to take more pictures and record longer movies using an xD-Picture Card (sold separately) than using the internal memory.

- ! "Using an xD-Picture Card" (p. 72)
- ! Be sure to press the **ON/OFF** button to turn off the camera before inserting or removing the card.
- ! Do not insert anything other than an xD-Picture Card or the microSD Attachment into the camera.

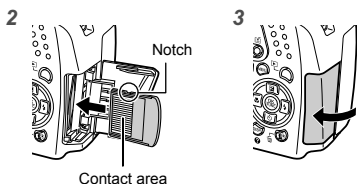
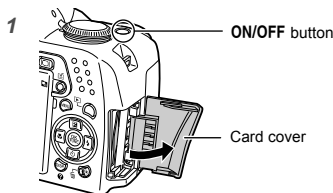

- ! Insert the card straight in until it clicks into place.
- ! Do not touch the contact area directly.

### To remove the xD-Picture Card

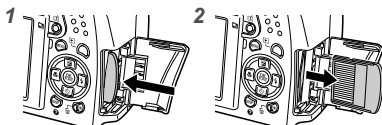

- ! Press in the card until it clicks and comes out slightly, and then grasp the card to pull it out.
- ! "Number of storable pictures (still pictures)/ continuous recording length (movies) in the internal memory and xD-Picture Card" (p. 73)

## Using the microSD card/ microSDHC card (sold separately)

microSD card/microSDHC card (hereinafter called the microSD card) is also compatible with this camera by using the microSD Attachment.

- ! "Using a microSD Attachment" (p. 74)

### 1 Insert the microSD card into the attachment.

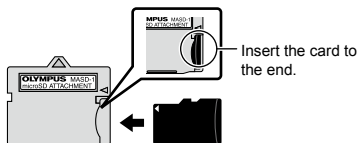

### 2 Insert the microSD Attachment into the camera.

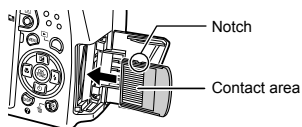



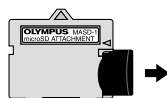

### To remove the microSD card



Pull the microSD card straight out.



- ! Do not touch the contact area of the microSD Attachment and microSD card directly.

## Arrow pad and operation guide

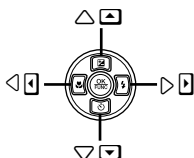
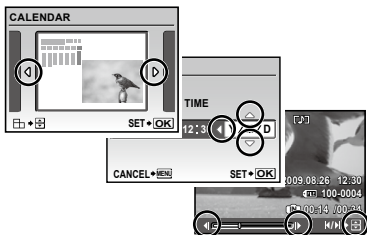
The symbols      displayed on various setting and movie playback screens indicate that the arrow pad is used.



Arrow pad

Operation guides displayed at the bottom of the screen indicate that the **MENU** button,  button, zoom lever or  button is used.

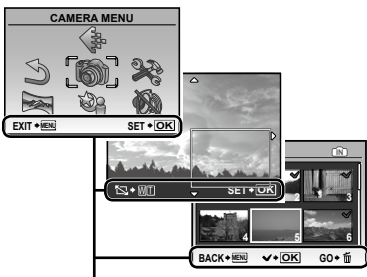

Operation guide

## Setting the date and time

The date and time set here are saved to image file names, date prints and other data.

### 1 Remove the lens cap, and press the ON/OFF button to turn on the camera.

- The date and time setting screen is displayed when the date and time are not set.

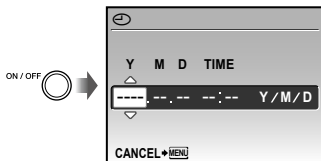



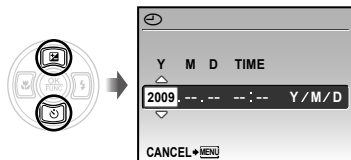

Date and time setting screen

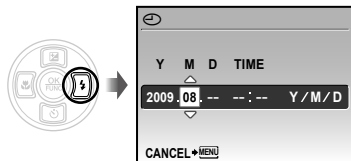

### 2 Use to select the year for [Y].



### 3 Press to save the setting for [Y].



- 4** As in steps 2 and 3, use    and the  button to set [M] (month), [D] (day), [TIME] (hours and minutes) and [Y/M/D] (date order).





- For precise time setting, press the  button as the time signal strikes 00 seconds.
- To change the date and time, make the setting from the menu.  (Date/time) (p. 54)

#### To check the date and time

Press the DISP. button while the camera is turned off. The current time is displayed for approx. 3 seconds.

## Changing the display language

The language for the menu and error messages displayed on the monitor/viewfinder is selectable.

- 1** Press the MENU button, and press    to select  (SETUP).

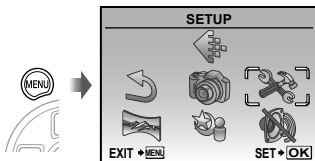



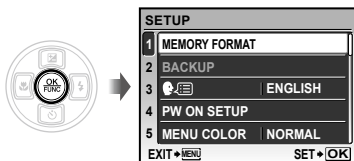

- 2** Press the  button.

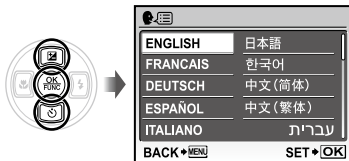

- 3** Use   to select  and press the  button.



- 4** Use    to select your language and press the  button.

- 5** Press the MENU button.



# Shooting, Playback and Erasing

## Shooting with automatic settings (AUTO mode)

This is a fully automatic mode that allows the user to take pictures by simply pressing the shutter button. Settings in the shooting menu cannot be changed in **AUTO** mode.

**1** Remove the lens cap.

**2** Set the mode dial to **AUTO**.



**3** Press the ON/OFF button to turn on the camera.

Number of storable still pictures (p. 73)



Monitor  
(standby mode screen)

**!** Press the ON/OFF button again to turn off the camera.

**4** Hold the camera, and compose the shot.

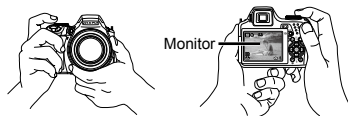

Horizontal grip



Vertical grip

**5** Press the shutter button halfway down to focus on the subject.

- When the camera focuses on the subject, the exposure is locked, and the AF target mark changes to green.
- The camera was unable to focus if the AF target mark flashes red. Try focusing again.



AF target mark

**!** "Focusing" (p. 68)

- 6** To take the picture, gently press the shutter button all the way down while being careful not to shake the camera.

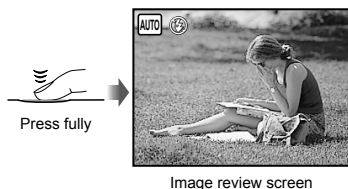

#### To view images during shooting

Pressing the button enables playback of images. To return to shooting, either press the button again or press the shutter button halfway down.

#### To shoot movies

"Shooting movies ( mode)" (p. 20)

#### To turn off the camera

Press the **ON/OFF** button to turn off the camera, and attach the lens cap to the lens.

## Viewing images

- 1** Set the mode dial to .

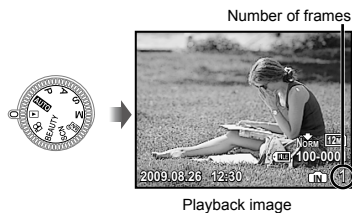

- 2** Use to select an image.

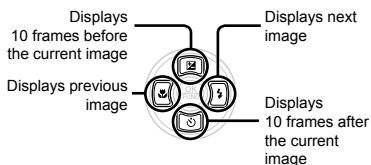

- The display size of the image can be changed. "Index view, calendar view and closeup view" (p. 27)

## To play back movies



Select a movie, and press the  button.



Movie

## Operations during movie playback

**Volume:** During playback, press  .





**Fast-forward/rewind:** Select with  . Each time a button is pressed, the playback speed cycles through 2x, 20x and standard (1x) speed in the direction of the pressed cursor button.

**Pause:** Press the  button.



During playback

## First (last) frame/frame advance:

During pause, press  to display the first frame, and press  to display the last frame. Press  to display the previous frame, and press  to display the next frame. Press the  button to resume playback.



During pause



## To stop movie playback

Press the **MENU** button.

## Erasing images during playback (Single image erase)

- 1 Press the  button when the playback image to be erased is displayed.



- 2 Press  to select [YES], and press the  button.

 [ERASE] (p. 49)





# Using Shooting Modes

## Using the best mode for the shooting scene (SCN mode)

### 1 Set the mode dial to SCN.



- The sample image and explanations on suitable shooting methods will be displayed on the screen. The explanations will be displayed as well by pressing down the **Q** button.

### 2 Use **Q** to select the best shooting mode for the scene, and press the **Q** button to set.

Icon indicating the scene mode that is set



- To change to another scene mode, use the menu. [**Q**] **SCN** (p. 40)

## Shooting with optimum aperture value and shutter speed (P mode)

In this mode, automatic camera shooting can be used while also allowing changes to a wide range of other shooting menu functions, such as exposure compensation, white balance, etc. on when needed.

### 1 Set the mode dial to P.

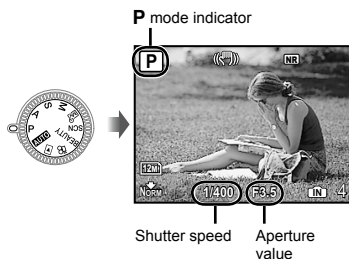

## Selecting the aperture value for shooting pictures (A mode)

In this mode, the shutter speed is automatically set by the camera. This is useful for shooting while controlling the range in which subjects appears sharp.

### 1 Set the mode dial to A.

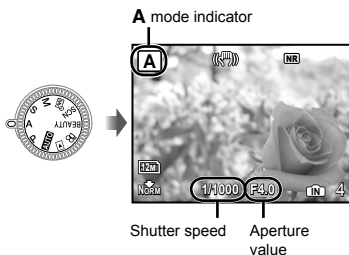

## Selecting the shutter speed for shooting pictures (S mode)

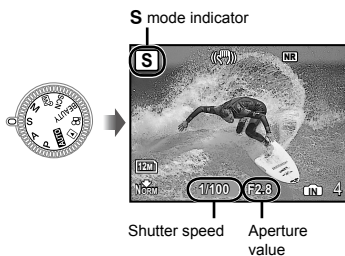

In this mode, the aperture value is automatically set by the camera. This is useful for shooting a moving subject, such as sports photos.

### 1 Set the mode dial to S.





### 2 After pressing , select the aperture value using , and press the button.



-  : Aperture value becomes larger (the range where the subjects appear sharp becomes wider).
-  : Aperture value becomes smaller (the range where the subjects appear sharp becomes narrower).
-  When the aperture value appears red, the correct exposure cannot be obtained.

### 2 After pressing , select the shutter speed using , and press the button.



-  : Shutter speed becomes faster (fast moving objects will be shot as though it was stationary).
-  : Shutter speed becomes slower (moving objects will become blurry when shot).
-  When the shutter speed appears red, the correct exposure cannot be obtained.

## Selecting the aperture value and shutter speed for shooting pictures (M mode)



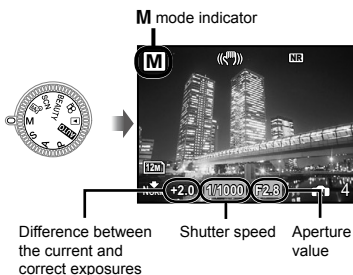

This mode enables the user to set the aperture value and shutter speed manually.

### 1 Set the mode dial to M.



### 2 After pressing , select the aperture value / shutter speed using , , and press the button.



-  : Aperture value becomes larger.
-  : Aperture value becomes smaller.
-  : Shutter speed becomes faster.
-  : Shutter speed becomes slower.

-  When the difference between the current and correct exposures exceeds EV±3.0, the indicator appears red.

### Long-exposure (bulb) shooting

Set the shutter speed to [BULB] by pressing . The shutter stays open while the shutter button is pressed and held.

-  The maximum time that the shutter can remain open is 8 minutes. This is possible only when [ISO] (p. 31) is set to [64].



## Smoothing out skin tone and texture (BEAUTY mode)

The camera finds a person's face and gives the skin a smooth, translucent look for taking the picture.

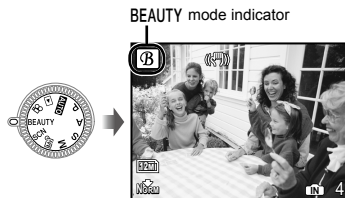
### 1 Set the mode dial to BEAUTY.



### 2 Point the camera toward the subject. Check the frame appearing around the face detected by the camera, and then press the shutter button to take the picture.

- The unedited image and edited image are both saved.
- If the image cannot be retouched, only the unedited image is saved.
-  The frame may not appear or may take some time to appear for some subjects. In addition, this function may have no visible effect on some subjects.
-  The [IMAGE SIZE] of the retouched image is limited to  or lower.

## Shooting movies (Movie mode)

- 1 Set the mode dial to .

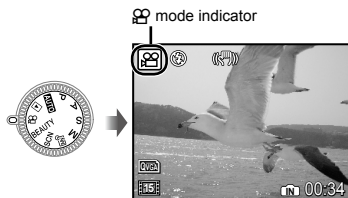

### To record audio when shooting

[ (Movie REC)] (p. 39)

### To zoom while recording audio

The optical zoom is not available when recording. Use [DIGITAL ZOOM] (p. 33).

- 2 Press the shutter button halfway down to focus on the subject, and gently press the button all the way down to start recording.

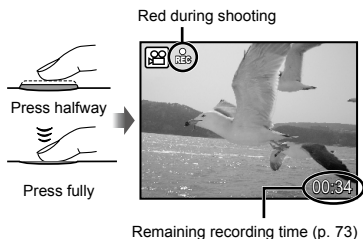

- 3 Gently press the shutter button all the way down to stop recording.



# Using Shooting Functions

## Using the optical zoom

Turning the zoom lever adjusts the shooting range.



Turning to the wide (W) end

Turning to the telephoto (T) end



Zoom bar

- ! Optical zoom: 26x, Digital zoom: 5x
- ! Use of [IMAGE STABILIZER] (p. 35) is recommended when shooting with the telephoto zoom.

### To take larger images without reducing image quality

[FINE ZOOM] (p. 33)

### To take larger images

[DIGITAL ZOOM] (p. 33)

- ! The zoom bar appearance identifies the status of the fine zoom/digital zoom.

When using optical zoom

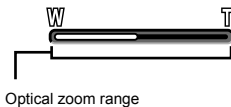

When using fine zoom

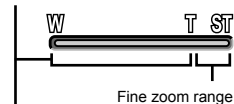

When using digital zoom

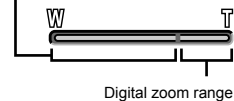

## Brightening the subject against backlight (SHADOW ADJ<sup>1</sup>)

The camera finds a person's face that has been darkened by backlight and makes it appear brighter.

<sup>1</sup> Shadow adjustment technology

### 1 Press the button.

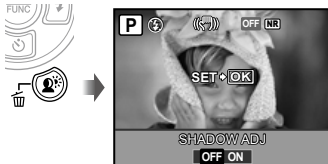

### 2 Use to select [ON], and press the button to set.

### 3 Point the camera toward the subject. Check the frame appearing around the face detected by the camera, and then press the shutter button to take the picture.

- ⚠ For some subjects, the frame may not appear or may take some time to appear.
- ⚠ [METERING] (p. 33) is automatically fixed to [ESP], and [AF MODE] (p. 34) is automatically fixed to [FACE DETECT].
- ⚠ [AF] is automatically switched to [AF-L]. Also, in sequential shooting, this function is applied only to the first frame. [DRIVE] (p. 32)

## Using the flash

The flash functions can be selected to best match the shooting conditions and render the desired image.

### 1 Press the button to flip up the built-in flash.

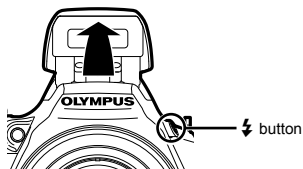

- ⚠ The flash settings cannot be adjusted with the flash closed.

### To turn off the flash

Press the flash down back into the camera. This sets to  (FLASH OFF) mode.

### 2 Press .

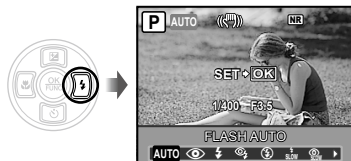

- 3** Use to select the setting option, and press the button to set.

Item	Description
FLASH AUTO <sup>*1</sup>	The flash fires automatically in low-light and backlight conditions.
REDEYE <sup>*1</sup>	This emits pre-flashes to reduce the occurrence of red eye in your photos.
FILL IN	The flash fires regardless of the available light.
RED-EYE + FILL-IN	After the pre-flashes that reduce the red eye, the flash fires regardless of the available light.
FLASH OFF	The flash does not fire.
SLOW	The flash fires at a slow shutter speed immediately after the shutter is opened (first curtain sync). Both the subject in the foreground and the night scene in the background are captured.
RED-EYE SLOW	This combines the pre-flashes of red-eye reduction with the flash in SLOW (first curtain sync).
SLOW2	The flash fires at a slow shutter speed immediately before the shutter is closed (second curtain sync). This can be used to create effects such as the taillights of a car streaming backwards.

<sup>\*1</sup> This cannot be set in **S** and **M** modes.

## Adjusting the brightness (Exposure compensation)

The standard brightness (correct exposure) set by the camera based on the shooting mode (except for **M**) can be adjusted brighter or darker to obtain the desired shot.

- 1** Press .

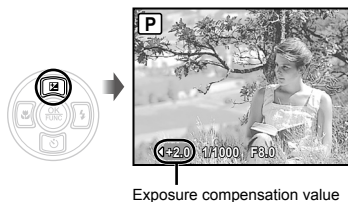

- 2** Use to adjust the brightness, and press the button to set.



## Shooting closeups (Macro shooting)

This function enables the camera to focus and shoot subjects at close distances.

### 1 Press .





### 2 Use to select the setting option, and press the button to set.

Item	Description
OFF	Macro mode is deactivated.
MACRO	This enables shooting as close as 10 cm (3.9 in.) <sup>1</sup> to the subject.
SUPER MACRO	This enables shooting as close as 1 cm (0.39 in.) <sup>2</sup> to the subject.

<sup>1</sup> When the zoom is at the widest (W) setting.

<sup>2</sup> The zoom is automatically fixed.

## Using the self-timer

After the shutter button is pressed all the way down, the picture is taken after a time delay. By securing the camera on a tripod, this function enables the user to take a picture of himself/herself at a distance from the camera () or to take pictures without the camera shake ().

### 1 Press .



### 2 Use to select the setting option, and press the button to set.

Item	Description
OFF	This cancels the self-timer.
12s SELF-TIMER	After setting, when the shutter button is pressed all the way down, the self-time lamp turns on for approx. 10 seconds, and then blinks for approx. 2 seconds before taking the picture.
2s SELF-TIMER	After setting, when the shutter button is pressed all the way down, the self-time lamp blinks for approx. 2 seconds before taking the picture.

 Self-timer shooting is automatically canceled after one shot.

### To cancel the self-timer after it starts

Press  again.

 The self-timer cannot be set when [AF PREDICT] (p. 35) is set to [ON] or [DRIVE] (p. 32) is set to [PRE-CAPTURE ON].



## Switching between the monitor and viewfinder

Both the monitor and viewfinder are available to compose a shot. There may be cases where the monitor is difficult to see due to bright light being reflected on it while shooting under a clear sky. In such cases, use of the view finder is helpful when composing a shot.

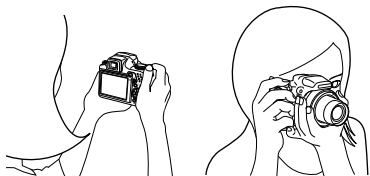

### 1 Press the button.

- Each time the button is pressed, the camera display switches between the monitor and the viewfinder.

### To view clearer images through the viewfinder

Turn the diopter adjustment dial while looking through the viewfinder until the viewfinder display appears sharp.

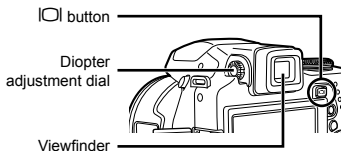

## Changing the shooting information display

The display of the screen information can be changed to best match the situation, such as clearing the view of the screen or for creating a precise composition by the use of the grid display.

### 1 Press the DISP. button.

- The displayed shooting information changes in the order shown below each time the button is pressed. "Shooting mode display" (p. 8)

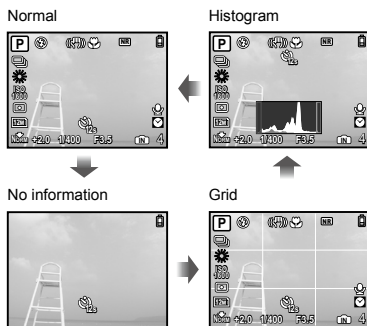

-  (Histogram) (p. 56)

### Reading a histogram

If the peak fills too much of the frame, the image will appear mostly white.

If the peak fills too much of the frame, the image will appear mostly black.

The green section shows the luminance distribution within the center of the screen.



## Locking the exposure and/or focus position for shooting (AE LOCK/AF LOCK)

Once the exposure and/or focus position are/is set for a subject in shooting mode, you can continue shooting at the same exposure, focus position or both (AE LOCK, AF LOCK or AF LOCK + AE LOCK) even if the composition of the shot is changed.

### 1 Assign either [AE LOCK], [AF LOCK] or [AF LOCK + AE LOCK] to the button.

- In the default setting, [AE LOCK] is assigned to this button.

 [CUSTOM BUTTON] (p. 57)

### 2 Compose the shot and press the button.

- The exposure/focus position setting assigned in step 1 is locked.

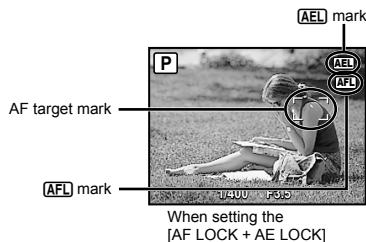

### To cancel the setting

Press the  button again so that the [AEL]/[AFL] mark no longer appears.

### 3 After changing the composition of the shot, press the shutter button.

## Using a function assigned to the button (Custom button)

This allows you to register a frequently used function (except **AUTO**, **BEAUTY**, ). Once registered, you can set the settings directly with the button instead of displaying the screen from the menu.

 [CUSTOM BUTTON] (p. 57)

### 1 Press the button.

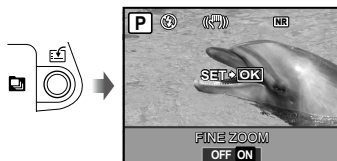





### 2 Use to select the setting option, and press the button to set.

## Using the FUNC menu

The FUNC menu provides the following menu functions that can be quickly called and set.

- [DRIVE] (p. 32)
- [WB] (p. 30)
- [METERING] (p. 33)
- [ IMAGE QUALITY] (p. 29)
- [MY MODE SETUP] (p. 56)
- [ISO] (p. 31)

 When the mode dial is set to the ,  to  are selectable.

### 1 Press the button before shooting.

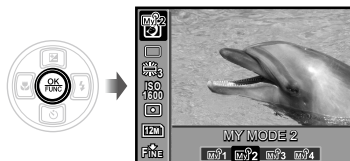

### 2 Use to select the menu function and to select the setting option, and then press the button to set.

# Using Playback Features

## Index view, calendar view and closeup view

Index view and calendar view enable quick selection of a target image, and closeup view (up to 10x magnification) allows checking of image details.

### 1 Turn the zoom lever.



W side

T side

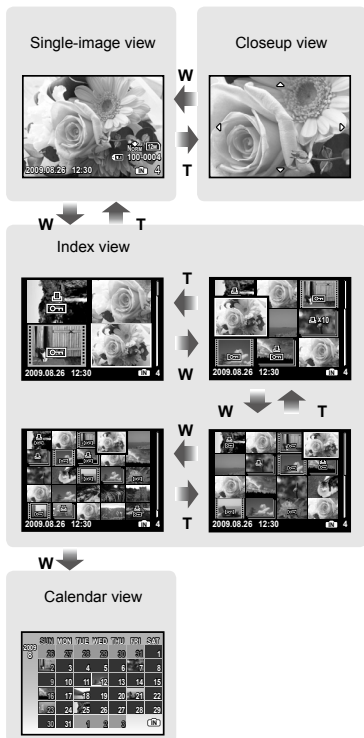

### To select an image in index view

Use to select an image, and press the button to display the selected image in single-image view.

### To select images in calendar view

Use to select a date, and either press the button or turn the zoom lever to T to view the images taken on the selected date.

### To scroll an image in closeup view

Use to move the viewing area.

## Changing the image information display

Shooting information displayed on the screen can be changed.

### 1 Press the DISP. button.

- The displayed image information changes in the order shown below each time the button is pressed.

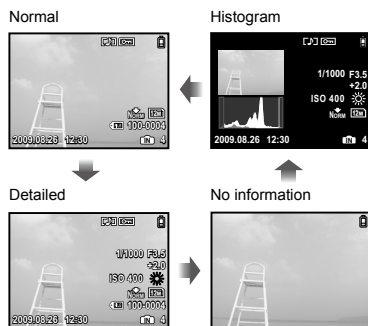

! (Histogram)] (p. 56), "Reading a histogram" (p. 25)

## Playing back sequentially shot images

For images that were shot sequentially with the below functions, only the first frame will be displayed.

[], [], [], [], [BKT], [TIMELAPSE], [] SMILE SHOT

### 1 Select an image with a sequential-shot icon during playback.

! "Viewing images" (p. 15)

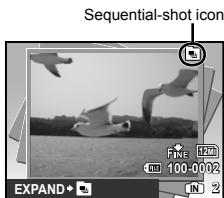

#### To perform automatic playback

Press the button. All the images taken in sequence will be played back automatically.

#### To display the index view

Press the button. To cancel, press the button again.



! Applying [] (Protect) (p. 48), [] (Rotate) (p. 48), [] PRINT ORDER (p. 49) and [ERASE] (p. 16) when displaying the first frame will apply the setting to all the images that were shot sequentially. To apply the settings to each frame individually, change to index view before setting.

## Playing back panoramic images

Panorama images that were combined together using [COMBINE IN CAMERA 1] or [COMBINE IN CAMERA 2] can be scrolled for viewing.

! [] PANORAMA (p. 42)

### 1 Select a panorama image during playback.

! "Viewing images" (p. 15)

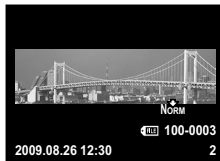

### 2 Press the button.

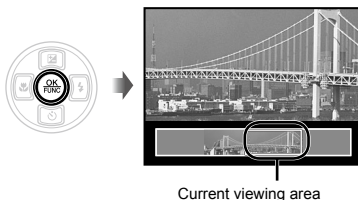

#### Operations during panorama image playback

**Zoom in/Zoom out** : Turn the zoom lever.

**Playback direction** : Press [] [] during zoom playback to scroll in the direction of the pressed button.



**Pause** : Press the button.

**Restart scrolling** : Press the button.

**Stop playback** : Press the **MENU** button.

# Menus for Shooting Functions

When the mode dial is set to a shooting mode, settings can be made.



- The icon next to  indicates the position to adjust the mode dial to when setting functions.
- The default settings of the function are highlighted in .

## Selecting the appropriate image quality for your application [ IMAGE QUALITY]

 IMAGE QUALITY



 : **AUTO P A S M**  **SCN BEAUTY**

### Still pictures

Submenu 1	Submenu 2	Application
IMAGE SIZE	12M (3968×2976)	Suitable for printing pictures over A3 (11×17 in.).
	5M (2560×1920)	Suitable for printing pictures at A4 (8.5×11 in.).
	3M (2048×1536)	Suitable for printing pictures up to A4 (8.5×11 in.).
	2M (1600×1200)	Suitable for printing pictures at A5 (5×7 in.).
	1M (1280×960)	Suitable for printing pictures at postcard size.
	VGA (640×480)	Suitable for viewing pictures on a TV or using pictures on emails and web sites.
	16:9  (3968×2232)	Suitable for conveying the expansiveness of subjects such as landscapes and utilizing the entire screen for viewing pictures on a widescreen TV. Also used for printing pictures at A3 (11×17 in.).
	16:9  (1920×1080)	Suitable for conveying the expansiveness of subjects such as landscapes and utilizing the entire screen for viewing pictures on a widescreen TV. Also used for printing pictures at A5 (5×7 in.).
COMPRESSION	FINE	Shooting at high quality.
	NORMAL	Shooting at normal quality.



### Movies

Submenu 1	Submenu 2	Application
IMAGE SIZE	VGA	Image size is set to 640x480. This will be played back in a full screen.
	QVGA	Image size is set to 320x240.
FRAME RATE	 30fps <sup>*1</sup>	Provides smoother video images. Shoots with image quality as the priority.
	 15fps <sup>*1</sup>	Provides standard video images. Shoots with movie length as the priority.

\*1 frames per second

-  "Number of storable pictures (still pictures)/continuous recording length (movies) in the internal memory and xD-Picture Card" (p. 73)

## Adjusting image color [WB]

CAMERA MENU ► WB

: P A S M BEAUTY

Submenu 2	Submenu 3	Application
AUTO	—	The camera automatically adjusts the white balance according to the shooting scene.
PRESET		For shooting outdoors under a clear sky
		For shooting outdoors under a cloudy sky
		For shooting under tungsten lighting
		For shooting under daylight fluorescent lighting (household lighting, etc.)
		For shooting under neutral fluorescent lighting (desk lamps, etc.)
(One-touch WB)	(Proceed to the setting screen.)	For setting a more precise white balance than preset white balance, [AUTO] or [PRESET].

### To set the One-touch WB

Select [, and aim the camera at a sheet of white paper which fills the screen, making sure there are no shadows, and then press the button.

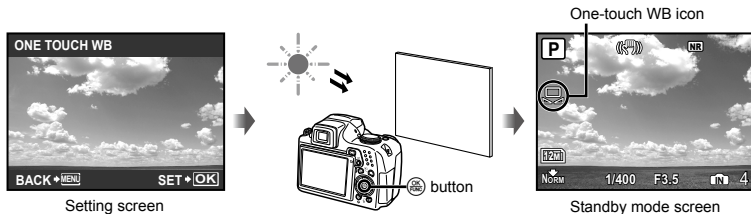

## Selecting the ISO sensitivity [ISO]

 CAMERA MENU ► ISO

 : P A S M 

- ! A method for indicating film speed by the International Organization for Standardization (ISO) (e.g. "ISO100").
- ! In the ISO setting, although smaller values result in less sensitivity, sharp images can be taken under fully lit conditions. Larger values result in higher sensitivity, and images can be taken at fast shutter speeds even under dimly lit conditions. High sensitivity introduces electronic noise into the resulting picture, which may give it a grainy appearance.







Submenu 2	Application
AUTO	The camera automatically adjusts the sensitivity according to the shooting scene.
HIGH ISO AUTO	The camera automatically adjusts to a higher sensitivity than [AUTO] to reduce blurring caused by camera shake and motion of the subject.
64/100/200/400/800/1600/ 3200/6400	Set ISO sensitivity to a numerical value.

- ! If set to [3200] [6400], [IMAGE SIZE] is limited to  or lower.
- ! The ISO setting of [3200] [6400] is not available when [FINE ZOOM] (p. 33) or [DIGITAL ZOOM] (p. 33) is set to [ON].
- ! [AUTO], [HIGH ISO AUTO] is not available when **M** mode is selected.











## Shooting pictures sequentially while the shutter button is held down [DRIVE]

 CAMERA MENU ► DRIVE

 : P A S M  SCN

Submenu 2	Submenu 3	Submenu 4	Application
	—	—	One frame is shot each time the shutter button is pressed.
 <sup>*1</sup>			Sequential shooting at a focus and brightness (exposure) that is locked in the first frame.
			Sequential shooting at a higher speed than  .
	PRE-CAPTURE OFF/ PRE-CAPTURE ON	—	Sequential shooting at a speed of approx. 10 frames/sec. When set to [PRE-CAPTURE ON], 10 frames (from pressing the button halfway down until shooting starts) will be saved.
	—	—	Sequential shooting while adjusting the focus for each image.
<b>BKT</b>	±0.3/±0.7/±1.0	×3/×5	Sequential shooting that automatically changes the exposure for each frame while using the focus and white balance that were locked at the first frame (Bracket shooting). The exposure interval and the number of shots are selectable.

\*1 The shooting speed varies depending on the settings for  [IMAGE QUALITY] (p. 29).

-  When set to  or , flash is fixed to  (FLASH OFF) mode and the available [ISO] settings are limited.
-  When set to , [IMAGE SIZE] is limited to  or lower, and the number of sequential images is approx. 25 or less. (When  and [COMPRESSION] of "FINE" are selected, the number becomes 20 or less.)
-  When set to , [IMAGE SIZE] is limited to  or lower, and the number of sequential images is approx. 25 or less. (This includes the 10 images immediately before shooting when [PRE-CAPTURE ON] is selected.)



### Shooting at magnifications higher than optical zoom without reducing the image quality [FINE ZOOM]

CAMERA MENU ► FINE ZOOM

: P A S M SCN BEAUTY

Submenu 2	Application
OFF	Only optical zoom is used to zoom in for shooting.
ON	Optical zoom and image cropping are combined to zoom in for shooting (up to 39×).

- This function will not reduce the image quality since it does not convert the data with fewer pixels into the data with larger pixels.
- When set to [ON], [IMAGE SIZE] is limited to or lower.
- When set to [ON], [DIGITAL ZOOM] is canceled automatically.
- [FINE ZOOM] is not available when SUPER MACRO (p. 24) is selected.

### Shooting at magnifications higher than optical zoom [DIGITAL ZOOM]

CAMERA MENU ► DIGITAL ZOOM

: P A S M SCN BEAUTY

Submenu 2	Application
OFF	Only optical zoom is used to zoom in for shooting.
ON	Optical zoom and digital zoom are combined to zoom in for shooting (Still pictures: Approx. 130x (max.), Movies: Approx. 78x (max.)).

- When set to [ON], [FINE ZOOM] is canceled automatically.
- [DIGITAL ZOOM] is not available when SUPER MACRO (p. 24) is selected.

### Selecting the range for measuring the brightness [METERING]

CAMERA MENU ► METERING

: P A S M SCN

Submenu 2	Application
ESP	Shoots to obtain a balanced brightness over the entire screen. (Meters the brightness at the center and surrounding areas of the screen separately.)
(spot)	Shoots the subject at the center during backlighting. (Meters the brightness within the AF target mark only.)
(center weighted)	Shoots without being affected by the surrounding brightness. (Meters a wide range based on the center section of the screen.)

- When set to [ESP], the center can appear dark when shooting against strong backlighting.

## Selecting the focusing area [AF MODE]

CAMERA MENU ► AF MODE

: P A S M

Submenu 2	Application
FACE DETECT <sup>1</sup>	This is used for taking pictures of people. The camera automatically detects and focuses on a face.
iESP	This enables you to compose the shot without worrying about the focusing position. The camera finds the subject to focus on and then automatically adjusts the focus.
SPOT	The camera focuses on the subject within the AF target mark.
AREA	The AF target mark position is moved to focus the camera on the subject located at a position other than the center.

<sup>1</sup> For some subjects, the frame may not appear or may take some time to appear.

### To move and lock the AF target mark [AREA]

Use to move the AF target mark (○) on the screen. To lock the AF target mark, press and hold the button until the mark changes to □. To unlock the AF target mark, press and hold the button until the mark changes to ○.

## Changing the focus method [FOCUS MODE]

CAMERA MENU ► FOCUS MODE

: P A S M

Submenu 2	Application
AF	Press the shutter button halfway. The camera automatically focuses.
MF	Adjust the focus manually.

### When set to [MF]

Rough indication of shooting distance (MF bar)

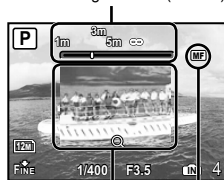

Enlarged view

- 1 Press to adjust the focus while checking the focus on the enlarged view.
- ! The display units in the MF bar can be selected. [m/ft] (p. 57)

### To lock the shooting distance

Press and hold the button until the mark turns red. To unlock the shooting distance, press and hold the button until the mark returns to green.

### Shooting pictures while keeping the subject in focus [FULLTIME AF]

CAMERA MENU ► FULLTIME AF

: P A S M SCN BEAUTY

Submenu 2	Application
OFF	Pressing the shutter button halfway down brings the subject into focus and locks the focus.
ON	Fulltime AF keeps the subject in focus, without having to press the shutter button down halfway. This reduces focusing time.

- Also, the subject is automatically kept in focus during movie shooting.

### Shooting pictures while focusing on subjects moving back and forth [AF PREDICT]

CAMERA MENU ► AF PREDICT

: P A S M SCN

Submenu 2	Application
OFF	Pressing the shutter button halfway down brings the subject into focus and locks the focus.
ON	When the shutter button is pressed halfway down, the camera tracks the focusing subject, and it continues to keep the subject in focus while the button is held halfway down. This reduces focusing time.

- The camera may not be able to bring some subjects into focus even when set to [ON].
- [AF PREDICT] is not available when using MACRO and SUPER MACRO. (p. 24)

### Using the AF illuminator to focus on a shadowy subject [AF ILLUMINAT.]

CAMERA MENU ► AF ILLUMINAT.

: P A S M SCN BEAUTY

Submenu 2	Application
OFF	The AF illuminator is not used.
ON	When the shutter button is pressed halfway down, the AF illuminator turns on to aid focusing.

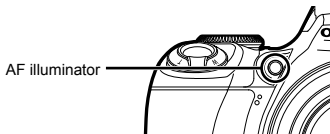

### Retouch the blur effects caused by the camera shake when shooting [IMAGE STABILIZER]

CAMERA MENU ► IMAGE STABILIZER

: P A S M SCN BEAUTY

Submenu 2	Application
OFF	The image stabilizer is deactivated. This is recommended for shooting when the camera is fixed in place on a tripod or other stable surface.
ON	The image stabilizer is used for taking pictures. Pressing the shutter button halfway down activates the stabilizing function.

- There may be a noise coming from inside the camera when the shutter button is pressed with [IMAGE STABILIZER] (still images) set to [ON].
- The image stabilizer can be less effective during night shooting and other situations where the shutter speed is extremely slow.
- Images may not be stabilized if camera shake is too severe.
- When set to [ON], shooting a movie for an extended period of time results in the camera heating up, and the protective circuit automatically shuts off the power.

## Adjusting the flash intensity

 CAMERA MENU  



 : P A S M  SCN BEAUTY

-  In certain situations, it is advisable to adjust the flash intensity, such as when shooting small subjects or distant backgrounds. This function is also used when increased contrast is desired.





Submenu 2	Application
-2.0 to +2.0	Adjust the flash intensity for the shooting scene.

## Using an external flash FLASH

 CAMERA MENU   FLASH

 : P A S M  SCN BEAUTY

Submenu 2	Submenu 3	Application
IN	—	The built-in flash is used for taking pictures.
 RC	CH1 to CH4	An Olympus Wireless RC Flash System compatible flash is used for taking pictures. The channel (CH1 to CH4) can be selected.
SLAVE	1 to 10	The commercially-available slave flash that is synchronized with the camera flash is used for taking pictures. The flash intensity setting can be adjusted.

-  "Taking pictures with the Olympus Wireless RC Flash System" (p. 74)
-  When set to [SLAVE], the flash setting automatically changes to  FILL IN] (p. 23).
-  When set to [SLAVE], the flash can fire when [DRIVE] (p. 32) is set to a setting other than  , but if the flash intensity is large, the interval between sequential shots becomes longer.

### Recording sound when shooting still pictures [M]

CAMERA MENU ►

: P A S M SCN

Submenu 2	Application
OFF	No sound is recorded.
ON	The camera automatically starts recording for approx. 4 seconds after taking the picture. This is useful for recording notes or comments about the picture.

- When recording, aim the microphone (p. 48) at the source of the sound you want to record.

### Adjusting the white balance [WBZ]

CAMERA MENU ► [WBZ]

: P A S M SCN BEAUTY

- ① Use to adjust the white balance and press the button to set.

The white balance can be adjusted in 7 steps in both the [BLUE] and [RED] directions.

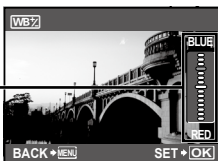

- [WB] (p. 30)

### Selecting the color tone of the image [PICTURE MODE]

CAMERA MENU ► PICTURE MODE

: P A S M

Submenu 2	Application
VIVID	This gives the image a vivid color tone.
NATURAL	This gives the image a natural color tone.

### Adjusting the sharpness of contours [SHARPNESS]

CAMERA MENU ► SHARPNESS

: P A S M SCN BEAUTY

Submenu 2	Application
-5 to +5	This adjusts the sharpness of contours. Adjust in the + direction to make the image appear sharper, and adjust in the - direction to make the image appear softer.

- If you adjust the sharpness too far in the + direction, noise may appear in the image.

## Adjusting the contrast of the image [CONTRAST]

 CAMERA MENU ► CONTRAST

 : P A S M  SCN BEAUTY 

Submenu 2	Application
-5 to +5	This adjusts the contrast between light and dark areas. Adjusting in the + direction produces a crisper image. Adjusting in the – direction softens the overall impression of the image.

## Adjusting the color saturation [SATURATION]

 CAMERA MENU ► SATURATION

 : P A S M  SCN BEAUTY 



Submenu 2	Application
-5 to +5	This adjusts the color saturation. Adjusting in the + direction produces deeper colors. Adjusting in the – direction produces more subdued colors.

## Reducing noise during long exposures [NOISE REDUCT.]

 CAMERA MENU ► NOISE REDUCT.

 : P A S M  SCN

Submenu 2	Application
OFF	The camera takes pictures at a fast shutter speed. No noise reduction is used.
ON	The camera takes pictures at a slow shutter speed. Noise reduction is activated when the shutter speed is slower than 1/2 second.

-  When set to [ON], the time for shooting and saving data is approx. twice as long as usual. During this wait time, no pictures can be taken.
-  This function may not work effectively for some subjects and shooting conditions.
-  This function is fixed to [ON] when the shutter speed is set to [BULB]. “Selecting the aperture value and shutter speed for shooting pictures (M mode)” (p. 19)

**Taking a preset number of shots at preset intervals [TIMELAPSE]**



CAMERA MENU ► TIMELAPSE

: P A S M  SCN

Submenu 2	Submenu 3	Submenu 4	Application
OFF	—	—	The timelapse shooting function is deactivated.
ON	2 to 99	1MIN to 99MIN	The timelapse shooting function is activated. The amount of images and shooting interval can be selected.



**Timelapse shooting**

Pressing the shutter button after setting the amount of images, shooting interval and setting this function to [ON], the first frame will be taken, and the camera takes the remaining frames thereafter automatically. The camera automatically enters sleep mode (p. 57) after the first frame has been saved. Sleep mode is exited around 7 seconds before the next shot. Once the preset number of frames is taken, the camera automatically turns off.

-  Use of new batteries or an AC adapter is recommended when taking frames over an extended period of time.
-  If any of the following operations are performed while the camera is in sleep mode, the camera cancels timelapse mode and returns to normal shooting: opening of the battery compartment cover or card cover, connecting the camera to a computer, pressing the shutter button or arrow pad.
-  If the internal memory or card or the battery power runs out during sleep mode, a warning is displayed, [TIMELAPSE] mode is canceled and the camera automatically turns off.



**Taking pictures with a conversion lens [D-]**CAMERA MENU ► : P A S M  SCN BEAUTY 

Submenu 2	Application
OFF	No conversion lens is used (camera body only).
ON	The camera takes pictures by attaching a conversion lens specified by Olympus (sold separately).

-  When a conversion lens is attached, light from the built-in flash can cause vignetting where shadows from the conversion lens appear on the images.
-  When a conversion lens is attached, the camera may take extra time to focus.

**Recording movie with sound [M]**CAMERA MENU ► :  

Submenu 2	Application
OFF	No sound is recorded.
ON	Sound is recorded while shooting movies.

-  Sounds may not be recorded clearly if the camera is more than 1m away from the sound source.
-  When set to [ON], [IMAGE STABILIZER] (p. 35) is not available.
-  When set to [ON], setting [FULLTIME AF] (p. 35) to [ON] may record the sound of the lens operating.

## Selecting a scene mode according to the shooting situation [SCN]

### SCN



- !** In **SCN** mode, the optimum shooting settings are pre-programmed for specific shooting scenes. For this reason, settings may not be changed in some modes.

Submenu 1	Application
PORTRAIT/ LANDSCAPE/ SPORT/ NIGHT SCENE <sup>1</sup> / NIGHT+PORTRAIT/ INDOOR/ CANDLE/ SUNSET/ FIREWORKS <sup>1</sup> / MULTI FIREWORKS/ MULTIPLE EXPOSURE/ CUISINE/ DOCUMENTS/ SMILE SHOT/ BEACH & SNOW/ BIRD WATCHING/ SOFT BACKGROUND SHOT/ PRE-CAPTURE MOVIE/ QUICK SHUTTER/	The camera takes a picture in the mode for the shooting scene.

<sup>1</sup> When the subject is dark, [NOISE REDUCT.] (p. 38) is automatically activated. Time taken to shoot will be doubled, and no other shooting can be done in that time.

- !** The sample image and explanations on suitable shooting methods will be displayed on the screen. The explanations will be displayed as well by pressing down the **?** button.

### To select a mode

"Using the best mode for the shooting scene (**SCN** mode)" (p. 17)

## Making an overlay image with fireworks

([MULTI FIREWORKS] mode)

- ① Select [MULTI FIREWORKS].

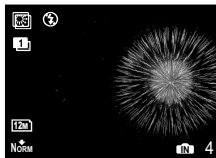

- ② Press the shutter button to take the first frame.

- The exposure is locked at the first frame. The saved image is displayed as the background.

- !** To retake the first shot, press the **?** button, and then press the shutter button again.

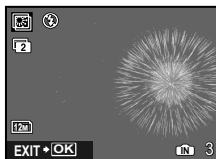

- ③ Adjust the position of the fireworks that will be taken in the second frame over the first frame used as the background, and then press the shutter button.

- The overlay image is saved as a separate image from the first and second frames.

- !** To retake the second shot, press the shutter button again.

## Making an overlay image

([MULTIPLE EXPOSURE] mode)

The method of shooting is the same as in [MULTI FIREWORKS] mode. While shooting settings cannot be changed in [MULTI FIREWORKS], it is possible to do so in [MULTIPLE EXPOSURE].



### Detecting a smiling face to release the shutter automatically ([] SMILE SHOT) mode)

- 1 Select [] SMILE SHOT], and then aim the camera towards the subject.
  - The self-timer lamp turns on. When a smiling face is detected, the camera automatically takes 3 sequential shots.
- ! Pictures can also be taken manually by pressing the shutter button.
- ! The camera may not be able to detect a smiling face for some subjects.
- ! [IMAGE SIZE] is limited to [] or lower.

### Capturing the perfect moment when shooting ([] PRE-CAPTURE MOVIE) mode)

- 1 Use [] to select [] PRE-CAPTURE MOVIE], and press the [] button to set.
  - This function is ready for shooting immediately after setting this option.
- 2 Press the shutter button to start movie shooting.
  - A 7-second movie, including 2-second movie immediately before pressing the shutter button, is taken.
  - The optical zoom and auto focus function are available during movie recording.
- ! Sound is not recorded.
- ! The AF target mark is not displayed.
- ! Select [IMAGE SIZE] from [] or [], and [FRAME RATE] from [] or [].

### Capturing the perfect moment when shooting ([] QUICK SHUTTER) mode)

- 1 Select [] QUICK SHUTTER], and then press the shutter button to take pictures.
  - The release time lag (time from when the shutter button is pressed until the shutter actually released) is shorter than normal.
- ! [FULLTIME AF] (p. 35) is automatically set to [ON].
- ! [] and [] can be set for [DRIVE] (p. 32).

### Taking pictures with blurred backgrounds ([] SOFT BACKGROUND SHOT) mode)

- 1 Use [] to select [] SOFT BACKGROUND SHOT], and press the [] button to set.
- 2 Use [] to select a frame, and then press the [] button.
  - Select from "Face", "Upper Body", "Whole Body" or "Circle".
- 3 Shoot the subject within the frame.
  - The frame can be moved by pressing [].

## Creating panoramic images

### [PANORAMA]

PANORAMA

SCN

Submenu 2	Application
COMBINE IN CAMERA1 <sup>1</sup> *2	Three frames are taken and combined by the camera. The user only composes the shots so that the target marks and pointers overlap, and the camera automatically releases the shutter. The shooting functions are already preset to the optimum settings for panoramic shooting.
COMBINE IN CAMERA2 <sup>2</sup>	Three frames are taken and combined by the camera. The user composes the shots using the guide frame and manually releases the shutter.
COMBINE IN PC	The frames that were taken are combined into a panoramic image using the OLYMPUS Master 2 software from the provided CD-ROM. Pictures are taken in the last [ISO] or [SCN] settings (except for some scene modes).

<sup>1</sup> Not available when **SCN** mode is selected.

<sup>2</sup> The [IMAGE QUALITY] (p. 29) setting cannot be changed.

- ! The focus, exposure (p. 14), zoom position (p. 21) and [WB] (p. 30) are locked at the first frame.
- ! The optical zoom is limited up to 10x.
- ! The flash (p. 23) is locked to [FLASH OFF] mode.
- ! Panoramic images can be edited using [SHADOW ADJ] (p. 44) only.
- ! "Playing back panoramic images" (p. 28)

## Taking pictures with [COMBINE IN CAMERA1]

- ① Press the shutter button to take the first frame.
- ② Move the camera slightly in the direction of the second frame.



Screen when combining images from left to right

- ③ Move the camera slowly while keeping it straight, and stop the camera where the pointer and target mark overlap.
  - The camera releases the shutter automatically.



- ! To combine only two pictures, press the [SCN] button before taking the third frame.
- ④ Take the third frame in the same way as step ③.
  - After the third frame is taken, the camera automatically processes the frames and the combined panoramic image is displayed.
- ! To cancel a panoramic picture during shooting, press the **MENU** button.
- ! When the shutter does not automatically release, try [COMBINE IN CAMERA2] or [COMBINE IN PC].

### Taking pictures with [COMBINE IN CAMERA]

- Use to select the direction that the frames are combined.

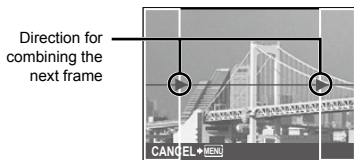

- Press the shutter button to take the first frame.
  - A guide frame appears as a reference.

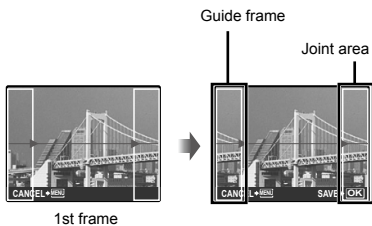

- Compose the second shot so that the joint area overlaps the guide frame.



- Press the shutter button to take the second frame.
  - To combine only two pictures, press the button before taking the third frame.
- Take the third frame in the same way as steps ③ to ④.
  - After the third frame is taken, the camera automatically processes the frames and the combined panoram image is displayed.
  - To cancel a panoramic picture during shooting, press the **MENU** button.

### Taking pictures with [COMBINE IN PC]

- Use to select the direction that the frames are combined.
- Press the shutter button to take the first frame, and then compose the second shot.
  - Compose the shot using the guide frame so that the two adjacent frames overlap.
- Repeat step ② until the number of required frames are taken, and then press the button when done.
  - When the mark is displayed, you cannot continue shooting any further. Panorama shooting is possible for up to 10 frames.
  - Refer to the OLYMPUS Master 2 help guide for details on how to create panoramic images.

### Restoring the shooting functions to the default settings [↶ RESET]

↶ RESET

: AUTO P A S M SCN BEAUTY

Submenu 1	Application
YES	Restores the following menu functions to the default settings. <ul style="list-style-type: none"> <li>SHADOW ADJ (p. 22)</li> <li>Flash (p. 22)</li> <li>Exposure compensation (p. 23)</li> <li>Macro (p. 24)</li> <li>Self-timer (p. 24)</li> <li>[ IMAGE QUALITY] (p. 29)</li> <li>[ SCN] (p. 40)</li> <li>Menu functions in [ CAMERA MENU] (p. 30 to 39)</li> <li>Switching between the monitor and viewfinder (p. 25)</li> </ul>
NO	The current settings are not changed.

# Menus for Playback, Editing and Printing Functions

Settings can be made when mode dial is set to .

## Playing back pictures automatically [ SLIDESHOW]

 SLIDESHOW



Submenu 1	Submenu 2	Submenu 3	Application
ALL <sup>*1*</sup> / STILL PICTURE/ MOVIE <sup>*1*</sup> / CALENDAR <sup>*1*</sup> / <sup>2</sup> / <sup>3</sup>	NORMAL/SCROLL/ FADER/SLIDE/ ZOOM DOWN/ZOOM UP/ CHECKERBOARD/BLINDS/ SWIVEL/RANDOM	OFF/ STANDARD/ SPEED/ CYBER/ AQUA/SHINY	Selects the coverage of images for the slideshow, the type of transition effect used between images and the background music.

\*1 [TYPE] is fixed to [NORMAL].

\*2 The movie sound will be played back when [OFF] in [BGM] is selected while in movie mode.



\*3 When [CALENDAR] is selected, select the date in the calendar playback screen.

### To start a slideshow







Make the [BGM] settings and press the  button to start the slideshow. To stop the slideshow, press the  button or **MENU** button.

## Retouching images [ PERFECT FIX]

 PERFECT FIX

-  Edited or retouched images cannot be retouched again.
-  Depending on the picture, the editing may not be effective.
-  The retouching process may lower the image resolution.

Submenu 1	Application
ALL	[SHADOW ADJ] and [REDEYE FIX] are applied together.
SHADOW ADJ	Only sections darkened by backlighting and dim lighting are brightened.
REDEYE FIX	Eyes that are reddened by the flash are corrected.

- Use   to select a correction method, and press the  button.
- Use   to select an image for retouching, and press the  button.
  - The retouched image is saved as a separate image.

## Retouching the skin and eyes

### [] BEAUTY FIX

#### BEAUTY FIX

- Depending on the picture, the editing may not be effective.

Submenu 1	Submenu 2	Application
ALL	—	[CLEAR SKIN], [SPARKLE EYE] and [DRAMATIC EYE] are applied together.
CLEAR SKIN	SOFT/AVG/HARD	Makes skin look smooth and translucent. Select the correction effect from 3 levels.
SPARKLE EYE	—	Enhances the contrast in the eyes.
DRAMATIC EYE	—	Enlarges the subject's eyes.

- Use [] to select a correction item, and press the button.
- Use [] to select an image for retouching, and press the button.
  - The retouched image is saved as a separate image.

### When [CLEAR SKIN] is selected

Use [] to select the retouching level, and press the button.



## Changing the image size []

### EDIT ▶

Submenu 2	Application
VGA 640 × 480	This saves a high-resolution image as a separate image with a smaller size for use in e-mail attachments and other applications.
QVGA 320 × 240	

- Use [] to select an image, and press the button.
- Use [] to select the image size, and press the button.
  - The resized image will be saved as a separate image.

## Cropping images []

### EDIT ▶

- Use [] to select an image, and press the button.
- Use the zoom lever to select the size of the cropping frame, and use [] to move the frame.



- Press the button.
  - The edited image will be saved as a separate image.

## Changing the color tone of image [COLOR EDIT]

EDIT ► COLOR EDIT

Submenu 2	Application
Black & white	This changes the image to black and white.
Sepia	This changes the image to a sepia tone.
Saturation (hard)	This increases the color saturation of the image.
Saturation (soft)	This slightly increases the color saturation of the image.

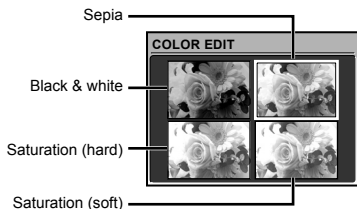

- 1 Use to select the desired preview image, and press the button.

- The modified image is saved as a new image.

## Adding a calendar to an image [CALENDAR]

EDIT ► CALENDAR

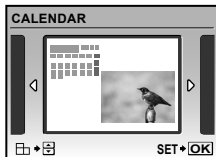

- 1 Use to select an image, and press the button.
- 2 Use to select the calendar, and then use to select the image orientation, and press the button.
- 3 Use to select the Year of the calendar, and press .
- 4 Use to select the Month of the calendar, and press the button.

- The edited image is saved as a separate image.

## Highlighting a face with blurry effect around it [FACE FOCUS]

EDIT ► FACE FOCUS

- 1 A face that is largest and facing front in the picture is detected as a target. In some images, such target may not be detected, and editing cannot be performed.
  - 1 Use to select an image, and press the button.
- The edited image is saved as a separate image.

## Creating an index of 9 frames from a movie [INDEX]

### EDIT ► INDEX

- ! This movie frame index can be saved for easily recalling the content of a movie. The scenes that are automatically extracted can be fine adjusted and reselected.

- ① Use  $\left[ \text{M} \right] \left[ \text{I} \right]$  to select a movie, and press the  $\left[ \text{INDEX} \right]$  button.

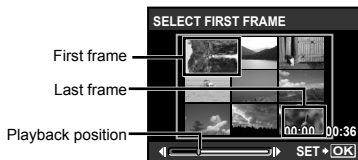

Frames are extracted automatically.

- ! If no fine adjustment of the frames is needed, simply press the  $\left[ \text{INDEX} \right]$  button in steps ② and ③.

- ② Select the first frame while using  $\left[ \text{L} \right] \left[ \text{R} \right]$  to move the frames forward or backward, and press the  $\left[ \text{INDEX} \right]$  button.

- While selecting the start or end frame, pressing  $\left[ \text{M} \right] \left[ \text{I} \right]$  moves to the start/end frame of the movie.

- ③ Select the last frame while using  $\left[ \text{L} \right] \left[ \text{R} \right]$  to move the frames forward or backward, and press the  $\left[ \text{INDEX} \right]$  button.

- The index image with 9 extracted frames from the movie is saved as a separate single image.

## Extracting a clip from a movie [EDIT]

### EDIT ► EDIT

Submenu 2	Application
NEW FILE	The original movie is left unchanged, and a clip from the movie is saved as a separate movie.
OVERWRITE	A portion of the original movie overwrites and replaces the original movie.

- ① Use  $\left[ \text{M} \right] \left[ \text{I} \right]$  to select a movie.
- ② Use  $\left[ \text{NEW} \right] \left[ \text{FILE} \right]$  or  $\left[ \text{OVERWRITE} \right]$  to select [NEWFILE] or [OVERWRITE], and press the  $\left[ \text{INDEX} \right]$  button.

- ③ Use  $\left[ \text{M} \right] \left[ \text{I} \right]$  to select the first frame of the clip to be extracted, and press the  $\left[ \text{INDEX} \right]$  button.

- While selecting the start or end frame, pressing  $\left[ \text{M} \right] \left[ \text{I} \right]$  moves to the start/end frame of the movie.

- ④ Use  $\left[ \text{M} \right] \left[ \text{I} \right]$  to select the last frame of the clip to be extracted, and press the  $\left[ \text{INDEX} \right]$  button.

- The extracted movie clip is saved.

## Extracting a still image from a movie [MOVIE INDEX]

### EDIT ► MOVIE INDEX

- ① Use  $\left[ \text{M} \right] \left[ \text{I} \right]$  to select a movie, and press the  $\left[ \text{INDEX} \right]$  button.

- ② Use  $\left[ \text{M} \right] \left[ \text{I} \right]$  to select the frame to be extracted, and press the  $\left[ \text{INDEX} \right]$  button.

- $\left[ \text{M} \right] \left[ \text{I} \right]$  can be used to move to the start/end frame of the movie.

- The selected frame is saved as a still image.

## Protecting images [Oπ]

▶ PLAYBACK MENU ▶ Oπ

- ⚠ Protected images cannot be erased by [ERASE] (p. 16), [SEL. IMAGE] or [ALL ERASE] (p. 49), but all images will be erased by [MEMORY FORMAT]/[FORMAT] (p. 50).

Submenu 2	Application
OFF	Images can be erased.
ON	Images are protected so that they cannot be erased except by formatting of the internal memory/card.

- 1 Use to select an image.
- 2 Use to select [ON].
- 3 If necessary, repeat steps 1 and 2 to protect other images, and then press the button.

## Rotating images []

▶ PLAYBACK MENU ▶

Submenu 2	Application
+90°	The image is rotated 90° clockwise.
0°	The image is not rotated.
-90°	The image is rotated 90° counter-clockwise.

- 1 Use to select an image.
  - 2 Use to select the rotation direction.
  - 3 If necessary, repeat steps 1 and 2 to make settings for other images and press the button.
- ⚠ The new picture orientations will be saved even after the power is turned off.

## Adding sound to still pictures []

▶ PLAYBACK MENU ▶

Submenu 2	Application
YES	The camera adds (records) sound for approx. 4 seconds while playing back the image. This is useful for recording notes or comments about the image.
NO	No sound is recorded.

- 1 Use to select an image.
- 2 Aim the microphone towards the sound source.



- 3 Use to select [YES], and press the button.
  - Recording starts.

## Selecting a position for starting playback [INDEX PLAY]

▶ PLAYBACK MENU ▶ INDEX PLAY

- 1 Use to select a movie, and press the button.
- 2 Use the zoom lever to select the position division.
  - One movie can be divided into 4, 9, 16 or 25 chapters.
- 3 Use to select a position, and press the button.
  - Playback starts from the selected position.



## Erasing images [ERASE]

### ERASE

- Check if there is any important data before erasing images.

Submenu 1	Application
SEL. IMAGE	Images are individually selected and erased.
ALL ERASE	All images in the internal memory or card are erased.

- When erasing pictures in the internal memory, do not insert the card into the camera.
- When erasing pictures from the card, insert a card into the camera in advance.

### To select and erase images

#### [SEL. IMAGE]

- Use [ZOOM] to select [SEL. IMAGE], and press the [OK] button.
- Use [ZOOM] to select the image to be erased, and press the [OK] button to add a ✓ mark to the image.



- Repeat step ② to select the images to be erased, and then press the [ERASE] button to erase the selected images.
- Use [ZOOM] to select [YES], and press the [OK] button.
  - The images with a ✓ mark are erased.

#### To erase all images [ALL ERASE]

- Use [ZOOM] to select [ALL ERASE], and press the [OK] button.
- Use [ZOOM] to select [YES], and press the [OK] button.

## Recording print settings to the image data [PRINT ORDER]



### PRINT ORDER

- “Print reservations (DPOF)” (p. 61)
- Print reservation can be set only for still pictures that are recorded to the card.

# Menus for Other Camera Settings

## Erasing data completely [MEMORY FORMAT]/[FORMAT]

 SETUP ► MEMORY FORMAT/FORMAT

-  Before formatting, check that no important data is left in the internal memory or card.
-  Non-Olympus cards and cards that have been formatted by a computer must be formatted with this camera before use.

Submenu 2	Application
YES	Completely erases the image data in the internal memory <sup>*1</sup> or card (including protected images).
NO	Cancels formatting.

<sup>\*1</sup> Be sure to remove the card before formatting the internal memory.

## Copying images in the internal memory to the card [BACKUP]

 SETUP ► BACKUP

Submenu 2	Application
YES	Backs up image data in the internal memory to the card.
NO	Cancels the backup.

-  It takes some time to back up data. Check that the battery has sufficient power before starting the backup, or use an AC adapter.

## Changing the display language

 SETUP ►  



Submenu 2	Application
Languages <sup>*1</sup>	The language for the menus and error messages displayed on the monitor is selected.

<sup>\*1</sup> The available languages vary depending on the country and/or region where the camera was purchased.

**Setting the startup display screen and sound [PW ON SETUP]**
 SETUP ► PW ON SETUP

Submenu 2	Submenu 3	Application
SCREEN	OFF	No image is displayed.
	1	A preset image <sup>1</sup> is displayed.
	2	A still image stored in the internal memory or card is registered for display. (This option leads to the setup screen.)
VOLUME <sup>2</sup>	OFF(No sound)/ LOW/HIGH	The volume of the startup sound is selected.



<sup>1</sup> This image cannot be changed.<sup>2</sup> When [SCREEN] is set to [OFF], this setting is not available.**To register a startup image**



- 1 Select [2] in submenu 3 for [SCREEN].
- 2 Use  to select the image to be registered, and press the  button.

**Selecting the menu screen color [MENU COLOR]**
 SETUP ► MENU COLOR

Submenu 2	Application
NORMAL/COLOR 1/ COLOR 2/COLOR 3	Selects the menu screen color according to your preference.

**Selecting the camera sound and its volume [SOUND SETTINGS]**
 SETUP ► SOUND SETTINGS

 In  SILENT MODE] (p. 57), all sounds can be set to be turned off.

Submenu 2	Submenu 3	Submenu 4	Application
BEEP	SOUND TYPE	1/2	Selects the operating sound and volume of the camera buttons (except the shutter button).
	VOLUME	OFF (No sound)/ LOW/HIGH	
SHUTTER SOUND	SOUND TYPE	1/2/3	Selects the shutter sound and volume.
	VOLUME	OFF (No sound)/ LOW/HIGH	
	OFF (No sound)/ LOW/HIGH	—	Selects the warning sound volume.
 VOLUME	5 levels excluding OFF (No sound)	—	Adjusts the image playback volume.

## Viewing the image immediately after shooting [REC VIEW]

🔍 SETUP ► REC VIEW

Submenu 2	Submenu 3	Application
OFF	—	The image being recorded is not displayed. This allows the user to prepare for the next shot while following the subject in the monitor or viewfinder after shooting.
ON	LCD ONLY	The last image being recorded is always displayed on the monitor.
	CURRENT	The last image being recorded is displayed on the currently selected display device (monitor or viewfinder). "Switching between the monitor and viewfinder" (p. 25)

⚠ Even when set to [ON], you can resume shooting while the image is being displayed.

## Selecting where the top menu is displayed [MENU DISPLAY]

🔍 SETUP ► MENU DISPLAY

Submenu 2	Application
LCD ONLY	The top menu is always displayed on the monitor.
CURRENT	The top menu is displayed on the currently selected display device (monitor or viewfinder).

⚠ The submenu chosen in [MENU DISPLAY] will be displayed on the screen when the following operations are done.

- Pressing the **MENU** button
- Pressing the  button in playback mode

## Increasing the brightness of the monitor when taking pictures [LIVE VIEW BOOST]

🔍 SETUP ► LIVE VIEW BOOST

Submenu 2	Application
OFF	The subject will be displayed on the monitor at the brightness level according to the exposure that was set. This allows you to preview the images to be captured on the monitor before shooting.
ON	The camera will automatically adjust the brightness level and display the subject on the monitor for easier confirmation. The results of the exposure compensation adjustment will not be shown on the monitor.

## Resetting the file names of images [FILE NAME]

SETUP ► FILE NAME

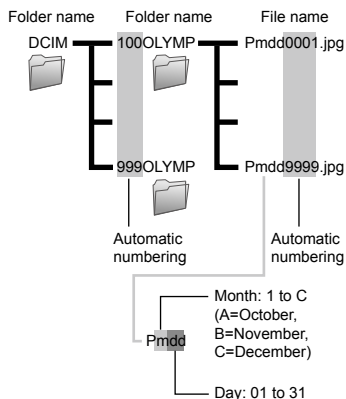

Submenu 2	Application
RESET	This resets the sequential number for the folder name and file name whenever a new card is inserted. <sup>1</sup> This is useful when grouping images on separate cards.
AUTO	Even when a new card is inserted, this continues the numbering for the folder name and file name from the previous card. This is useful for managing all image folder names and files names with sequential numbers.

<sup>1</sup> The number for the folder name is reset to 100, and the number for the file name is reset to 0001.

## Adjusting the CCD and image processing function [PIXEL MAPPING]

SETUP ► PIXEL MAPPING

- ! This function has already been adjusted at factory shipping, so no adjustment is needed right after purchase. Approximately once a year is recommended.
- ! For best results, wait at least 1 minute after taking or viewing pictures before performing pixel mapping. If the camera is turned off during pixel mapping, repeat the pixel mapping process.

### Adjusting the CCD and image processing function

- 1 Press the button when [START] (submenu 2) is displayed.
  - The camera checks and adjusts the CCD and the image processing function at the same time.

## Adjusting the brightness of the monitor [!]

SETUP ► [!]

- Use [ ] [ ] to adjust the brightness while viewing the screen, and then press the [ ] button.



## Setting the date and time [⌚]

SETUP ► [⌚]

- "Setting the date and time" (p. 12)

### To select the date display order

- Press [ ] after setting Minute, and use [ ] [ ] to select the date display order.

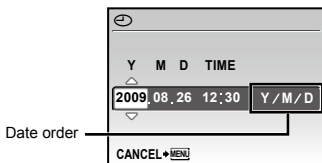

## Setting the date and time in another time zone [DUALTIME]

SETUP ► DUALTIME

- The date and time set in the [ON] setting are reflected on the image file names and date prints.

Submenu 2	Submenu 3	Application
OFF	—	Switches to the date and time set in [⌚ (Date/time)].
ON	(Proceeds to the setting screen <sup>1)</sup> .)	Switches to the date and time that were set in [DUALTIME] when using the camera in another time zone.

<sup>1</sup> The setting procedure is identical to that in "Setting the date and time" (p. 12)

- The date display order is the same as that set with [⌚].

## Automatically rotating images shot with the camera in a vertical position during playback [PIC ORIENTATION]

SETUP ► PIC ORIENTATION

- During shooting, the [ ] (p. 48) setting on the playback menu is set automatically.
- This function may not work properly if the camera is facing upwards or downwards during shooting.

Submenu 2	Application
OFF	Information about the vertical/horizontal orientation of the camera during shooting is not recorded with images. Images shot with the camera in a vertical position are not rotated during playback.
ON	Information about the vertical/horizontal orientation of the camera during shooting is recorded with images. Images are automatically rotated during playback.

## Selecting a video signal system to match your TV [VIDEO OUT]

### SETUP ► VIDEO OUT

- ⓘ The TV video signal system varies depending on the countries and regions. Before viewing camera images on your TV, select the video output according to your TV's video signal type.

Submenu 2	Application
NTSC	Connecting the camera to a TV in North America, Taiwan, Korea, Japan, etc.
PAL	Connecting the camera to a TV in European countries, China, etc.

- ⓘ The factory default settings differ according to the region where the camera is sold.

### To play back camera images on a TV

- ① Connect the TV and camera.

- Connection via AV cable

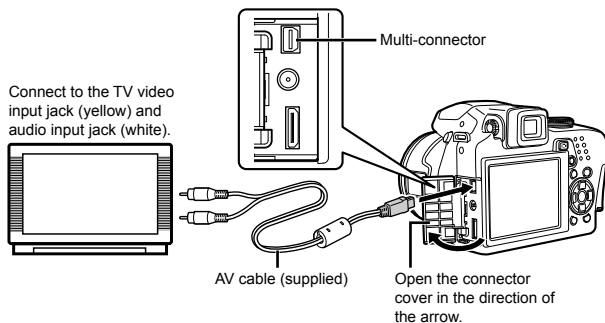

- Connection via HDMI cable

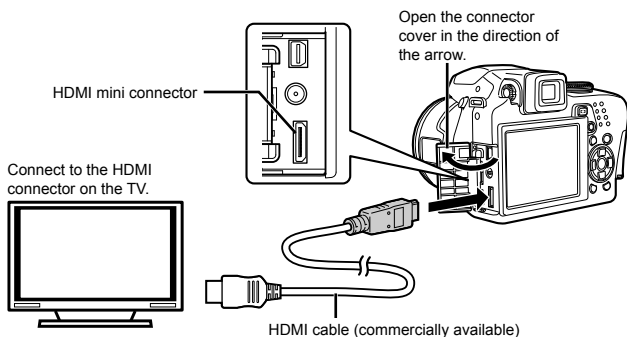

- ② Use the camera to select the video signal format that matches that of the connected TV ([NTSC]/[PAL]).
- ③ Turn on the TV, and change "INPUT" to "VIDEO (an input jack connected to the camera)."

- ❗ For details on changing the input source of the TV, refer to the TV's instruction manual.
- ❗ Set the mode dial to  when connecting via an AV cable.
- ❗ Use an HDMI cable that matches the HDMI mini connector on the camera and the HDMI connector on the TV.
- ❗ The movie playback screen cannot be displayed when connecting via an HDMI cable. In addition, the sound will not be played.
- ❗ When the camera and TV are connected by both an AV cable and an HDMI cable, the HDMI cable will take priority.
- ❗ Depending on the TV's settings, the displayed images and information may become cropped.

### Selecting the digital video signal format for connecting to a TV via an HDMI cable [HDMI]

 SETUP ► HDMI

- ❗ "To play back camera images on a TV" (p. 55)

Submenu 2	Application
480p	Images are played back in 480p format.
720p	Images are played back in 720p format.
1080i	Images are played back in 1080i format.

- ❗ When set to [1080i], 1080i format takes priority for HDMI output. However, if this setting does not match the input setting of the TV, the resolution is changed first to 720p and then to 480p. For details on changing the input setting of the TV, refer to the TV's instruction manual.

### Displaying the brightness distribution









 SETUP ► 

Submenu 2	Application
OFF	No histogram is displayed.
ON	A histogram (a brightness distribution as a guide for determining the exposure) is displayed.
DIRECT	White-out areas are displayed as red, and black-out areas are displayed as blue directly on the image.



- ❗ "Changing the shooting information display" (p. 25), "Changing the image information display" (p. 27)

### Registering a set of shooting settings under my mode labels [MY MODE SETUP]

 SETUP ► MY MODE SETUP

Submenu 2	Submenu 3	Submenu 4	Application
CURRENT	 MY MODE 1/  MY MODE 2/	SET/CANCEL	[SET] sets the current menu function settings to the selected my mode label (  /  /  /  ).
RESET	 MY MODE 3/  MY MODE 4	RESET/CANCEL	[RESET] returns the functions in the selected my mode label to their defaults.

#### Taking pictures using "MY MODE"

- ① Set the mode dial to .
- ② Select the desired mode from  to . "Using the FUNC menu" (p. 26)



## Selecting the display units during manual focus [m/ft]

SETUP ► m/ft

! "Changing the focus method [FOCUS MODE]" (p. 34)

Submenu 2	Application
m	This displays in meters and centimeters.
ft	This displays in feet and inches.

## Assigning functions to the button [CUSTOM BUTTON]

SETUP ► CUSTOM BUTTON

! "Using a function assigned to the  button (Custom button)" (p. 26)

Submenu 2	Application
AE LOCK <sup>1</sup> /AF LOCK <sup>2</sup> /AF LOCK + AE LOCK <sup>3</sup> / IMAGE SIZE (p. 29)/COMPRESSION (p. 29)/ FINE ZOOM (p. 33)/DIGITAL ZOOM (p. 33)/ AF MODE (p. 34)/FOCUS MODE (p.34)/ FULLTIME AF (p. 35)/AF PREDICT (p. 35)/ IMAGE STABILIZER (p. 35) <sup>3</sup> FLASH (p. 36)/  (p. 37)/NOISE REDUCT. (p. 38)	The assigned function is called and set at the touch of a button.

<sup>1</sup>This assigns the function that locks the exposure.

<sup>2</sup>This assigns the function that locks the focus position.

<sup>3</sup>This assigns the function that locks the exposure and focus position.

## Saving battery power between shots [SLEEP]

SETUP ► SLEEP

Submenu 2	Application
1MIN/3MIN/ 5MIN/10MIN	When the camera is not being used, the monitor/viewfinder automatically turn off to save battery power (sleep mode). This selects and sets the time until sleep mode is activated.

! When the camera is not being used for approx. 12 minutes in sleep mode, the camera automatically turns off.

### To cancel sleep mode

Press the shutter button, arrow pad or turn the mode dial.

## Turning off the camera sounds [ SILENT MODE]

SILENT MODE

Submenu 1	Application
OFF	Settings are selected individually in [SOUND SETTINGS] (p. 51).
ON	Startup sound, operating sound, shutter sound, warning sound and playback sound are muted.

# Printing

## Direct printing (PictBridge<sup>1</sup>)

By connecting the camera to a PictBridge-compatible printer, you can print images directly without using a computer.

To find out if your printer supports PictBridge, refer to the printer's instruction manual.

<sup>1</sup> PictBridge is a standard for connecting digital cameras and printers of different makers and printing out pictures directly.

- ! The printing modes, paper sizes and other setting options that can be set with the camera vary depending on the printer that is used. For details, refer to the printer's instruction manual.
- ! For details on the available paper types, loading paper and installing ink cassettes, refer to the printer's instruction manual.

## Printing at the printer's standard settings [EASY PRINT]

- 1 Display the image to be printed on the monitor.
  - ! "Viewing images" (p. 15)
  - ! Printing can also be started when the camera is turned off. After performing step 2, use to select [EASY PRINT], press the button. Use to select an image, press the button.

- 2 Turn on the printer, and then connect the printer and camera.

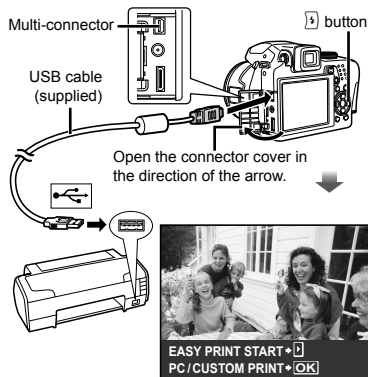

- 3 Press to start printing.
- 4 To print another image, use to select an image, and press the button.

### To exit printing

After a selected image is displayed on the screen, disconnect the USB cable from the camera and printer.



## Changing the printer's settings for printing [CUSTOM PRINT]

- 1 Follow steps 1 and 2 for [EASY PRINT] (p. 58), and press the button.

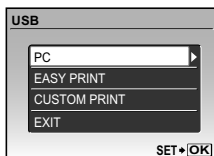

- 2 Use to select [CUSTOM PRINT], and press the button.

- 3 Use to select print mode, and press the button.

Submenu 2	Application
PRINT	This prints the image selected in step 6.
ALL PRINT	This prints all images stored in the internal memory or card.
MULTI PRINT	This prints one image in a multiple layout format.
ALL INDEX	This prints an index of all images stored in the internal memory or card.
PRINT ORDER <sup>1</sup>	This prints images based on the print reservation data on the card.

<sup>1</sup> [PRINT ORDER] is available only when print reservations were made. "Print reservations (DPOF)" (p. 61)

- 4 Use to select [SIZE] (Submenu 3), and press .

If the [PRINTPAPER] screen is not displayed, the [SIZE], [BORDERLESS] and [PICS/SHEET] are set to the printer's standard.

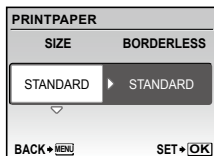

- 5 Use to select the [BORDERLESS] or [PICS/SHEET] settings, and press the .

Submenu 4	Application
OFF/ ON <sup>1</sup>	The image is printed with a border around it ([OFF]). The image is printed to fill the entire page ([ON]).
(The number of images per sheet varies depending on the printer.)	The number of images per sheet ([PICS/SHEET]) is selectable only when [MULTI PRINT] is selected in step 3.

<sup>1</sup> The available settings for [BORDERLESS] vary depending on the printer.

If [STANDARD] is selected in steps 4 and 5, the image is printed at the printer's standard settings.



## 6 Use to select an image.

## 7 Press to set the displayed image for single reservation.

Press to make detailed printer settings for the displayed image.

To make the detailed printer settings

- 1 Use , and press the button.

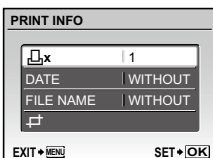

Submenu 5	Submenu 6	Application
x	0 to 10	This selects the number of prints.
DATE	WITH/ WITHOUT	Selecting [WITH] prints the images with the date. Selecting [WITHOUT] prints the images without the date.
FILE NAME	WITH/ WITHOUT	Selecting [WITH] prints the file name on the image. Selecting [WITHOUT] does not print any file name on the image.
	(Proceeds to the setting screen.)	This selects a portion of the image for printing.

### To crop an image ()

- 1 Use the zoom lever to select the size of the cropping frame, use to move the frame, and then press the button.



- 2 Use to select [OK], and press the button.



## 8 If necessary, repeat steps 6 and 7 to select the image to be printed, make the detailed settings and set [SINGLEPRINT].

## 9 Press the button.

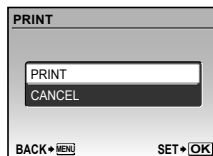



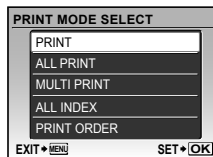

## 10 Use to select [PRINT], and press the button.

- Printing starts.
- When printing all images, select [OPTION SET], and the [PRINT INFO] screen is displayed.
- When printing is finished the [PRINT MODE SELECT] screen is displayed.



## To cancel printing

- 1 Press the  button when [TRANSFERRING] is displayed.
- 2 Select [CANCEL] using , , and press the  button.

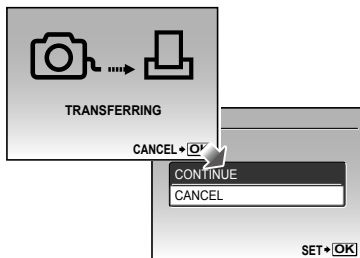

**11** Press the MENU button.

**12** When the message [REMOVE USB CABLE] is displayed, disconnect the USB cable from the camera and printer.

## Print reservations (DPOF<sup>1</sup>)

In print reservations, the number of prints and date imprint option are saved in the image on the card. This enables easy printing at a printer or print shop supporting DPOF by using only the print reservations on the card without a computer or a camera.







<sup>1</sup> DPOF is a standard for storing automatic printout information from digital cameras.

- ! Print reservations can be set only for the images stored on the card. Insert a card with recorded images before making print reservations.





- ! DPOF reservations set by another DPOF device cannot be changed by this camera. Make changes using the original device. Making new DPOF reservations with this camera will erase the reservations made by the other device.

- ! DPOF print reservations can be made for up to 999 images per card.

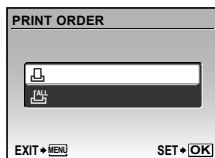
## Single-frame print reservations

- 1 Set the mode dial to , and then press the MENU button to display the top menu.
- 2 Use , , , and  to select  (PRINT ORDER), and press the  button.



- 3 Use , , and  to select , and press the  button.



- 4 Use to select the image for print reservation. Use to select the quantity. Press the button.



- 5 Use to select the (date print) screen option, and press the button.

Submenu 2	Application
NO	This prints the image only.
DATE	This prints the image and the shooting date.
TIME	This prints the image and the shooting time.

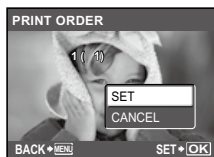

- 6 Use to select [SET], and press the button.

### Reserving one print each of all images on the card

- 1 Follow steps 1 and 2 in (p. 61).
- 2 Use to select , and press the button.
- 3 Follow steps 5 to 6 in .

### Resetting all print reservation data

- 1 Set the mode dial to , and then press the MENU button to display the top menu.
- 2 Use to select (PRINT ORDER), and press the button.
- 3 Select either or , and press the button.

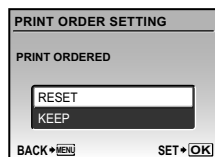



- 4 Use to select [RESET], and press the button.

## **Resetting the print reservation data for selected images**



---

- 1** Follow steps 1 and 2 of “Resetting all print reservation data” (p. 62).



---

- 2** Use  to select , and press the  button.

---

- 3** Use  to select [KEEP] and press the  button.



---

- 4** Use  to select the image with the print reservation you want to cancel. Use  to set the print quantity to “0”.



---

- 5** If necessary, repeat step 4, and then press the  button when finished.

---

- 6** Use  to select the  (date print) screen option, and press the  button.
  - The settings are applied to the remaining images with the print reservation data.

---

- 7** Use  to select [SET], and press the  button.

# Using OLYMPUS Master 2

## System requirements and installation of OLYMPUS Master 2

Install the OLYMPUS Master 2 software referring to the included installation guide.

## Connecting the camera to a computer

### 1 Make sure the camera is turned off.

- The monitor is off.
- The lens is retracted.

### 2 Connect the camera to a computer.

- The camera automatically turns on.

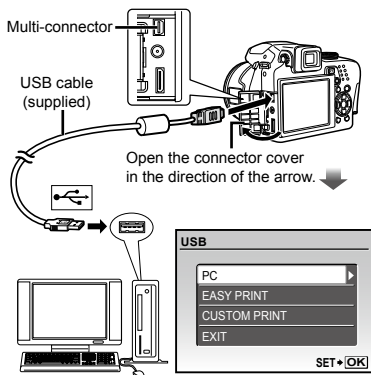

- ! Locate the position of the USB port by referring to your computer instructions manual.

### 3 Use to select [PC], and press the button.

- The computer automatically detects the camera as a new device on the first connection.

## Windows

After the computer detects the camera, a message indicating the completion of the setting appears. Confirm the message and click "OK". The camera is recognized as a removable disk.

## Macintosh

When iPhoto starts, exit iPhoto and start OLYMPUS Master 2.

- ! While the camera is connected to the computer, shooting functions are disabled.
- ! Connecting the camera to a computer via a USB hub may cause unstable operation.
- ! When [MTP] is set for the submenu that appears by pressing after selecting [PC] in step 3, images cannot be transferred to a computer using OLYMPUS Master 2.

## Starting OLYMPUS Master 2

### 1 Double-click the OLYMPUS Master 2 icon.

## Windows

appears on the desk top.

## Macintosh

appears in the OLYMPUS Master 2 folder.

- Browse window appears after starting the software.
- ! When you start OLYMPUS Master 2 for the first time after installation, "Default Settings" and "Registration" screen appear. Follow the instructions on the screen.



## Operating OLYMPUS Master 2

When OLYMPUS Master 2 is started, Quick Start Guide appears on the screen and helps you to handle the camera without any questions. When the Quick Start Guide is not displayed, click  in the tool bar to show the Guide.



For details on the operation, refer to the help guide of the software.



## Transferring and saving images without OLYMPUS Master 2

This camera is compatible with the USB Mass Storage Class. You can transfer and save the image data on your computer while the camera and the computer are connected.

### System requirements

Windows : Windows 2000 Professional/  
XP Home Edition/  
XP Professional/  
Vista

Macintosh : Mac OS X v10.3 or later

-  On a computer running Windows Vista, if [MTP] is set for the submenu that appears by pressing [S] after selecting [PC] in step 3 of "Connecting the camera to a computer" (p. 64), Windows Photo Gallery will become available.
-  Even if a computer has USB ports, proper operation is not guaranteed in the following cases.
  - computers with USB ports installed using an expansion card, etc.
  - computers without a factory-installed OS and home-built computers



# Usage Tips

If the camera does not work as intended, or if an error message is displayed on the screen, refer to the information below to fix the problem(s).

## Troubleshooting

### Battery

**"The camera does not work even when batteries are installed"**

- Insert new or recharged batteries in the correct direction.

"Loading the batteries" (p. 10)

- Battery performance may have been reduced temporarily due to low temperature. Take the batteries out of the camera, and warm them by putting them in your pocket for a while.

### Card/Internal memory

**"An error message is displayed"**

"Error message" (p. 67)



### Shutter button

**"No picture is taken when the shutter button is pressed"**

- Cancel sleep mode.

To save battery power, the camera automatically enters sleep mode and the monitor turns off if there is no operation for a certain amount of time when the camera is turned on (the lens is extended and the monitor is on). You can select the time to enter the sleep mode from 1, 3, 5 or 10 minutes. No picture is taken even if the shutter button is fully pressed in this mode. Operate the shutter button or other buttons to restore the camera from sleep mode before taking a picture. If the camera is further left for 12 minutes, it automatically turns off (the lens retracts and the monitor turns off). Press the **ON/OFF** button to turn the camera on.

[SLEEP] (p. 57)

- Set the mode dial to a position other than .
- Wait until  (flash charge) stops blinking before taking pictures.
- With prolonged camera use, the internal temperature may increase, resulting in automatic shutdown. If this occurs, remove the battery from the camera and wait until the camera has sufficiently cooled.

The camera's external temperature may also increase during use, however this is normal and does not indicate malfunction.

### Monitor/Viewfinder

**"Nothing is displayed/Difficult to see"**

- Change the display with the  button.
- Use the diopter adjustment dial to bring the display into focus.

"Switching between the monitor and viewfinder" (p. 25)

- Condensation<sup>1</sup> may have occurred. Turn off the power, and wait for the camera body to become acclimated to the surrounding temperature and dry out before taking pictures.

<sup>1</sup> Dew drops can form in the camera when it is suddenly taken from a cold location into a warm, humid room.

**"Vertical lines appear on the screen"**

- Vertical lines will appear on the screen when the camera is pointed at an extremely bright subject under a clear sky and so on. The lines do not appear, however, in the final still image.

**"The light is caught in the picture"**

- Shooting with flash in dark situations results in an image with many flash reflections on dust in the air.

### Date and time function

**"Date and time settings returns to the default setting"**

- If the batteries are removed and left out of the camera for about 3 days<sup>2</sup>, the date and time settings returns to the default setting, and must be reset.

<sup>2</sup> The time until the date and time settings returns to the default setting varies depending on how long the batteries have been loaded.

"Setting the date and time" (p. 12)

### Saving settings

**"Settings are not saved after the power is turned off"**

- When mode dial is set to **P, A, S, M**, or : settings will be saved even if the power is turned off (except for self-timer, [PANORAMA] and [TIMELAPSE]).

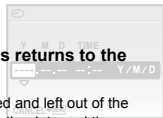
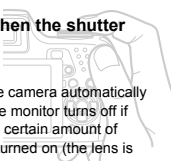
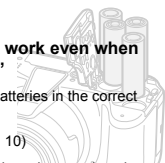
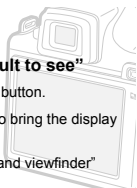

- When mode dial is set to **AUTO**, **SCN** or **BEAUTY**: settings will be changed back to default when the power is turned off (except for [⇐ IMAGE QUALITY]).





## Other









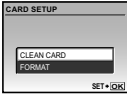
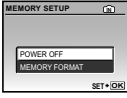

“There is a noise coming from inside the camera during shooting”

- The movement of the lens may make a noise even if the camera is not being operated because the autofocus function is active when the camera is ready to shoot.

## Error message

- When one of the messages below is displayed on the LCD monitor, check the following.

Error message	Corrective action
 <b>CARD ERROR</b>	<b>Card problem</b> Insert a new card.
 <b>WRITE PROTECT</b>	<b>Card problem</b> Use a computer to cancel the read-only setting.
 <b>MEMORY FULL</b>	<b>Internal memory problem</b> <ul style="list-style-type: none"> <li>Insert a card.</li> <li>Erase unwanted images.<sup>1</sup></li> </ul>
 <b>CARD FULL</b>	<b>Card problem</b> <ul style="list-style-type: none"> <li>Replace the card.</li> <li>Erase unwanted images.<sup>1</sup></li> </ul>
	<b>Card problem</b> <ul style="list-style-type: none"> <li>Use [Z] [OK] to select [CLEAN CARD], and press the [OK] button. Take out the card, wipe the contact area (p. 72) with a soft, dry cloth, and then load the card again.</li> <li>Use [Z] [OK] to select [FORMAT], and press the [OK] button. Next, use [Z] [OK] to select [YES], and press the [OK] button.<sup>2</sup></li> </ul>
	<b>Internal memory problem</b> Use [Z] [OK] to select [MEMORY FORMAT], and press the [OK] button. Next, use [Z] [OK] to select [YES], and press the [OK] button. <sup>2</sup>
<b>Recording has stopped to allow camera to cool. Please wait a moment.</b>	<b>Operation problem</b> Allow the camera to cool down before you begin shooting again.
<b>Camera is cooling. Please wait a moment.</b>	

 <b>NO PICTURE</b>	<b>Internal memory/Card problem</b> Take pictures before viewing them.
 <b>PICTURE ERROR</b>	<b>Problem with selected image</b> Use photo retouch software, etc. to view the image on a computer. If the image still cannot be viewed, the image file is corrupted.
 <b>THE IMAGE CANNOT BE EDITED</b>	<b>Problem with selected image</b> Use photo retouch software, etc. to edit the image on a computer.
 <b>CARD-COVER OPEN</b>	<b>Operation problem</b> Close the card cover.
 <b>BATTERY EMPTY</b>	<b>Battery problem</b> <ul style="list-style-type: none"> <li>Insert new batteries.</li> <li>If using rechargeable batteries, charge the batteries.</li> </ul>
 <b>NO CONNECTION</b>	<b>Connection problem</b> Connect the camera and computer or printer correctly.
 <b>NO PAPER</b>	<b>Printer problem</b> Load paper into the printer.
 <b>NO INK</b>	<b>Printer problem</b> Refill the ink in the printer.
 <b>JAMMED</b>	<b>Printer problem</b> Remove the jammed paper.
<b>SETTINGS CHANGED<sup>3</sup></b>	<b>Printer problem</b> Return to the status where the printer can be used.
 <b>PRINT ERROR</b>	<b>Printer problem</b> Turn off the camera and printer, check the printer for any problems and then turn the power on again.
 <b>CANNOT PRINT<sup>4</sup></b>	<b>Problem with selected image</b> Use a computer to print.

<sup>1</sup> Before erasing important images, download them to a computer.

<sup>2</sup> All data will be erased.

<sup>3</sup> This is displayed, for instance, when the printer's paper tray has been removed. Do not operate the printer while making the print settings on the camera.

<sup>4</sup> This camera may be unable to print images taken by other cameras.

## Shooting tips

When you are unsure of how to take a picture that you envision, refer to the information below.

### Focusing



#### “Focusing on the subject”

- **Taking a picture of a subject not in the center of the screen**

After focusing on an object at the same distance as the subject, compose the shot and take the picture.

Pressing the shutter button halfway (p. 14)

AF lock (p. 26)

Select a location that will be focused in a preliminarily determined composition.

[AREA] (p. 34)

- **Taking a picture of a shadowy subject**

Using the AF illuminator makes focusing easier.

[AF ILLUMINAT.] (p. 35)

- **Taking a picture of subjects where autofocus is difficult**

In the following cases, after focusing on an object (by pressing the shutter button halfway down) with high contrast at the same distance as the subject, compose the shot and take the picture.

Subjects with low contrast



When extremely bright objects appear in the center of the screen



Object with no vertical lines<sup>\*1</sup>

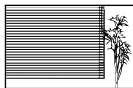

<sup>\*1</sup> It is also effective to compose the shot by holding the camera vertically to focus and then returning to the horizontal position to take the picture.

When objects are at different distances



Fast-moving object



The subject is not in the center of the frame



## Camera shake



### “Taking pictures without camera shake”

- **Taking pictures using [IMAGE STABILIZER] (p. 35)**

The CCD<sup>1</sup> shifts to correct for camera shake even if the ISO speed is not increased. This function is also effective when taking pictures at a high zoom magnification.

<sup>1</sup> An image pickup device that absorbs incoming light through the lens and changes it to electronic signals.

- **Set to S mode or [SPORT] in shooting mode**

Pictures can be taken at a high shutter speed, which is effective even for motion of the subjects.

S mode (p. 18)

[SCN] (p. 40)

- **Taking pictures using high ISO speed**

If a high ISO speed is selected, pictures can be taken at a high shutter speed even at locations where a flash cannot be used.

[ISO] (p. 31)

## Exposure (brightness)



### “Taking pictures with the right brightness”

- **Taking pictures of a subject against a backlight**

A face against backlight is brightened.

[SHADOW ADJ] (p. 22)

- **Taking pictures using [FACE DETECT] for [AF MODE] (p. 34)**

Appropriate exposure is obtained for a face against backlight, and the face is brightened.

- **Taking pictures using [METERING] (p. 33)**

The brightness is adjusted according to the subject in the center of the screen without being influenced by the background light.

- **Taking pictures using [FILL IN] (p. 23) flash**

A subject against backlight is brightened.

- **Taking pictures of a white beach or snow scene**

Set the mode to [BEACH & SNOW]. (p. 40)

- **Taking pictures using exposure compensation (p. 23)**

Adjust the brightness while viewing the screen for taking the picture. Normally, taking pictures of white subjects (such as snow) results in images that are darker than the actual subject. Use the [ ] button to adjust in the positive (+) direction to express whites as they appear.

When taking pictures of black subjects, on the other hand, it is effective to adjust in the negative (-) direction.

## Image colors

**WB**

### “Taking pictures with colors at the same shade as they appear”

- **Taking pictures by selecting [WB] (p. 30)**

Best results in most environments can normally be obtained with the AUTO setting, but for some subjects, you should try experimenting with different settings. (This is especially true for sunshade under a clear sky, mixed natural and artificial light settings, and so on.)

## Image quality



### “Taking sharper pictures”

- **Taking pictures with the optical zoom**

Avoid using [DIGITAL ZOOM] (p. 33) to take pictures.

- **Taking pictures at a low ISO sensitivity**

If the picture is taken with a high ISO sensitivity, noise (small colored spots and color unevenness that were not in the original image) can occur, and the image can appear grainy. This camera is provided with [NOISE REDUCT.] (p. 38), but when the ISO sensitivity is increased, the resulting image is grainier than with low ISO sensitivities. [ISO] (p. 31)

## Panorama



### “Taking pictures so that the frames are stitched smoothly”

- **A tip for panoramic shooting**

Taking pictures by pivoting with the camera at the center prevents shifting of the image. When taking pictures of close objects in particular, pivoting with the lens end at the center produces favorable results.

## Batteries



### “Making batteries last longer”

- **Avoid the conditions described below as power is consumed continuously causing batteries to become exhausted quickly**

- Repeatedly pressing the shutter button halfway
- Repeated use of the zoom

- **Avoid using [FULLTIME AF] (p. 35)**

- **Using the viewfinder**

“Switching between the monitor and viewfinder” (p. 25)

## Playback/Editing tips

### Playback



#### “Playing images in the internal memory or card”

- **Remove the card when playing images in the internal memory**

- “Loading the xD-Picture Card™ (sold separately) into the camera” (p. 11)
- “Using the microSD card/microSDHC card (sold separately)” (p. 11)

#### “Viewing images with high picture quality on a high-definition TV”

- **Connect the camera to the TV using an HDMI cable (commercially available)**

- “To play back camera images on a TV” (p. 55)
- “Selecting the digital video signal format for connecting to a TV via an HDMI cable [HDMI]” (p. 56)

### Editing



#### “Erasing the sound recorded to a still image”

- **Record over the sound with silence when playing back the image**

[🔇 (Post REC)] (p. 48)

# Appendix

## Camera care

### Exterior

- Wipe gently with a soft cloth. If the camera is very dirty, soak the cloth in mild soapy water and wring well. Wipe the camera with the damp cloth and then dry it with a dry cloth. If you have used the camera at the beach, use a cloth soaked in clean water and wrung well.

### Monitor and viewfinder

- Wipe gently with a soft cloth.

### Lens

- Blow dust off the lens with a commercial blower, then wipe gently with a lens cleaner.
  - ! Do not use strong solvents such as benzene or alcohol or chemically treated cloth.
  - ! Mold may form on the lens surface if the lens is left dirty.

## Storage

- When storing the camera for extended periods, remove the battery, AC adapter and card, and keep in a cool, dry place that is well ventilated.
- Periodically insert the battery and test the camera functions.
  - ! Avoid leaving the camera in places where chemical products are handled since this may result in corrosion.

## Battery handling precautions

- In addition to the batteries provided with the camera, the following types of battery can be used. Choose the power source best suited to the situation.

### AA alkaline batteries

The number of pictures that you can take may vary considerably depending on the battery manufacturer and shooting conditions.

### AA NiMH batteries (rechargeable batteries)

Being rechargeable, Olympus NiMH batteries are reusable and economical. For details, refer to the instruction manual for your charger.

### ! CAUTION:

There is a risk of explosion if the battery is replaced with the incorrect battery type. Dispose of the used battery following the instructions. "Battery Handling Precautions" (p. 78)

- **The following types of batteries cannot be used:**
  - Lithium battery pack (CR-V3)/AA (R6) manganese (zinc-carbon) batteries/AA (R6) oxyride batteries/AA (R6) lithium batteries**
- Power consumption by the camera varies depending on which functions are used.
- Power is consumed continuously during the conditions described below causing batteries to become exhausted quickly.
  - The zoom is used repeatedly.
  - The shutter button is pressed halfway repeatedly in shooting mode, activating the auto focus and digital image stabilization.
  - Set [FULLTIME AF] to [ON].
  - The monitor is left on for an extended period of time.
  - The camera is connected to a computer or printer.
- Battery life varies depending on the type of battery, manufacturer, shooting conditions, etc. Similarly, the camera may turn off without displaying the battery level warning or may display the battery level warning more quickly.

## Using an AC adapter

An AC adapter is useful for time-consuming tasks such as image downloads to a computer or when running a slideshow for a long period of time.

Do not use any other AC adapter with this camera.

## Using your AC adapter abroad

- The AC adapter can be used in most home electrical sources within the range of 100 V to 240 V AC (50/60Hz) around the world. However, depending on the country or area you are in, the AC wall outlet may be shaped differently and the AC adapter may require a plug adapter to match the wall outlet. For details, ask at your local electrical shop or travel agent.
- Do not use travel voltage converters as they could damage your AC adapter.

## Using an xD-Picture Card

A card (and internal memory) also corresponds to the film that records images in a film camera. Otherwise, the recorded images (data) can be erased, and retouching is also available with the use of a computer. Cards can be removed from the camera and exchanged, but it is not possible to remove or exchange the internal memory. Use of larger capacity cards enables you to take more pictures.

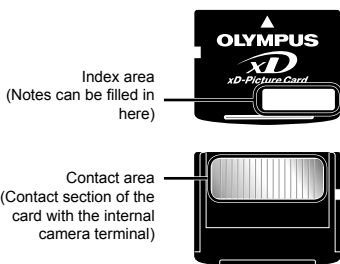

⚠ Do not touch the contact area directly.

## Cards compatible with this camera

xD-Picture Card (16MB to 2GB)  
(TypeH/M/M+, Standard)

## Using a new card

Before using a non-Olympus card or a card that was used for another purpose in a computer or other device, use [MEMORY FORMAT]/[FORMAT] (p. 50) to format the card.

## Checking the image saving location

The memory indicator shows whether the internal memory or card is being used during shooting and playback.

## Current memory indicator

- ◻: Internal memory is being used
- ◻: None: Card is being used

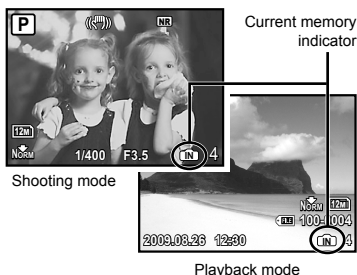

- ⚠ Even if [MEMORY FORMAT]/[FORMAT], single image erase, [SEL. IMAGE] or [ALL ERASE] is performed, the data in the card is not completely erased. When disposing of the card, damage the card to prevent the disclosure of personal data.



## Readout/recording process of the card

Never open the battery cover or card cover while the camera is reading or writing data, which is indicated by blinking of the card access lamp. This can not only damage the image data but also render the internal memory or card unusable.

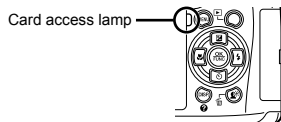

## Number of storable pictures (still pictures)/continuous recording length (movies) in the internal memory and xD-Picture Card

### Still pictures

IMAGE SIZE	COMPRES- SION	Number of storable still pictures			
		Internal memory		Using a 1 GB xD-Picture Card	
		With sound	Without sound	With sound	Without sound
12M 3968×2976	FINE	3	3	173	174
	NORM	7	7	340	343
5M 2560×1920	FINE	9	9	404	410
	NORM	17	17	770	789
3M 2048×1536	FINE	13	14	615	627
	NORM	25	26	1142	1184
2M 1600×1200	FINE	21	22	954	984
	NORM	38	41	1728	1827
1M 1280×960	FINE	31	32	1390	1453
	NORM	53	57	2369	2558
VGA 640×480	FINE	110	130	4920	5814
	NORM	179	239	7995	10660
L-Size 3968×2232	FINE	5	5	230	231
	NORM	10	10	447	453
S-Size 1920×1080	FINE	20	20	900	927
	NORM	35	37	1599	1683

### Movies

IMAGE SIZE	FRAME RATE	Continuous recording length			
		Internal memory		Using a 1 GB xD-Picture Card	
		With sound	Without sound	With sound	Without sound
VGA 640×480	30	12 sec.	12 sec.	9 min. 25 sec.*	9 min. 28 sec.*
	15	25 sec.	25 sec.	18 min. 44 sec.	18 min. 56 sec.
QVGA 320×240	30	34 sec.	34 sec.	25 min. 26 sec.	25 min. 49 sec.
	15	1 min. 7 sec.	1 min. 9 sec.	50 min. 7 sec.	51 min. 38 sec.

The maximum file size of a single movie is 2 GB, regardless of the capacity of the card.

\* The maximum length is 40 seconds when using a TypeM or Standard xD-Picture Card.

## Increasing the number of pictures that can be taken

Either erase unwanted images, or connect the camera to a computer or other device to save the images, and then erase the images in the internal memory or card.

Single image erase (p. 16), [SEL. IMAGE] (p. 49), [ALL ERASE] (p. 49), [MEMORY FORMAT]/[FORMAT] (p. 50)

## Using a microSD Attachment

- Do not use the attachment with Olympus digital cameras that do not support this microSD Attachment, as well as with other brands of digital cameras, computers, printers and other devices that support xD-Picture Card. Doing so not only may damage the pictures taken, but may also result in the malfunction of the device.
- If the microSD card cannot be removed, do not use force. Contact authorized distributors/service centers.

### Cards compatible with this camera

microSD card  
microSDHC card

- For a list of tested microSD cards, please visit our website (<http://www.olympus.com/>).

### Sending images

You can send images to a computer or PictBridge compatible printer by using the USB cable provided with the camera. To send data to other devices, remove the attachment from the camera and use a commercially available microSD card adapter.

### Handling precautions

Do not touch the contact area of the attachment or microSD card. Doing so may cause failure in reading the images. When fingerprints or stains are found on the contact area, wipe the area with a soft dry cloth.

## Taking pictures with the Olympus Wireless RC Flash System

You can take pictures with a wireless flash when using a flash compatible with the Olympus Wireless RC Flash System. This enables multi-flash photography using multiple flash units compatible with this system. The camera's built-in flash is used for communication between the camera and flash.

- For details about operation of a wireless flash, refer to the instruction manual for the special external flash.

### 1 Set the wireless flash based on the guidelines below.

#### Wireless flash setup range guidelines

- The setup range varies depending on the ambient environment.

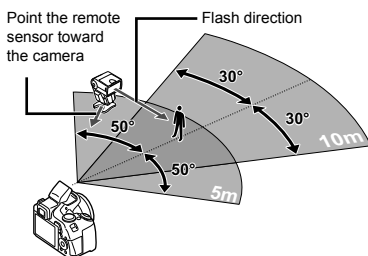

### 2 Turn on the wireless flash.

### 3 Use the MODE button on the wireless flash to set to RC mode, and make the channel and group settings.

- The group is set to A. (The B and C settings do not work.)

### 4 Turn on the camera, and press the button to flip up the built-in flash.

### 5 Set [ FLASH] (p. 36) on the camera to [ RC], and set the channel (CH1 to CH4) to the same setting as the wireless flash.



## 6 Select the flash mode.





- ! "Using the flash" (p. 22)
- ! [👁️ RED EYE], [👁️ ⚡ RED-EYE + FILL-IN] and [👁️ SLOW RED-EYE SLOW] are not available when [⚡ RC] is selected.

## 7 Take a test shot to check the operation of the flash and the resulting image.

- ! Be sure to check the charge level of the camera and wireless flash before taking pictures.
- ! Although there is no limit on the number of wireless flash units that are set up, usage of a maximum of 3 units is recommended to prevent malfunction due to interference with each other.
- ! When the camera flash is set to [⚡ RC], the camera built-in flash is used for communication with the wireless flash. It can not be used for taking pictures.
- ! When using a wireless flash while the camera flash is set to [👁️ SLOW2], set the shutter speed to 4 seconds or less. Otherwise, the picture will not be taken properly.

## SAFETY PRECAUTIONS

	<b>CAUTION</b> RISK OF ELECTRIC SHOCK DO NOT OPEN	
CAUTION: TO REDUCE THE RISK OF ELECTRICAL SHOCK, DO NOT REMOVE COVER (OR BACK). NO USER-SERVICEABLE PARTS INSIDE. REFER SERVICING TO QUALIFIED OLYMPUS SERVICE PERSONNEL.		

-  An exclamation mark enclosed in a triangle alerts you to important operating and maintenance instructions in the documentation provided with the product.
-  **DANGER** If the product is used without observing the information given under this symbol, serious injury or death may result.
-  **WARNING** If the product is used without observing the information given under this symbol, injury or death may result.
-  **CAUTION** If the product is used without observing the information given under this symbol, minor personal injury, damage to the equipment, or loss of valuable data may result.

**WARNING!**  
TO AVOID THE RISK OF FIRE OR ELECTRICAL SHOCK, NEVER DISASSEMBLE, EXPOSE THIS PRODUCT TO WATER OR OPERATE IN A HIGH HUMIDITY ENVIRONMENT.

### General Precautions

- Read All Instructions** — Before you use the product, read all operating instructions. Save all manuals and documentation for future reference.
- Cleaning** — Always unplug this product from the wall outlet before cleaning. Use only a damp cloth for cleaning. Never use any type of liquid or aerosol cleaner, or any type of organic solvent to clean this product.
- Attachments** — For your safety, and to avoid damaging the product, use only accessories recommended by Olympus.
- Water and Moisture** — For precautions on products with weatherproof designs, read the weatherproofing sections.
- Location** — To avoid damage to the product, mount the product securely on a stable tripod, stand or bracket.
- Power Source** — Connect this product only to the power source described on the product label.
- Lightning** — If a lightning storm occurs while using an AC adapter, remove it from the wall outlet immediately.
- Foreign Objects** — To avoid personal injury, never insert a metal object into the product.
- Heat** — Never use or store this product near any heat source such as a radiator, heat register, stove or any type of equipment or appliance that generates heat, including stereo amplifiers.

## Handling the Camera

### WARNING

- **Do not use the camera near flammable or explosive gases.**
- **Do not use the flash and LED on people (infants, small children, etc.) at close range.**
  - You must be at least 1 m (3 ft.) away from the faces of your subjects. Firing the flash too close to the subject's eyes could cause a momentary loss of vision.
- **Keep young children and infants away from the camera.**
  - Always use and store the camera out of the reach of young children and infants to prevent the following dangerous situations which could cause serious injury:
    - Becoming entangled in the camera strap, causing strangulation.
    - Accidentally swallowing the battery, cards or other small parts.
    - Accidentally firing the flash into their own eyes or those of another child.
    - Accidentally being injured by the moving parts of the camera.
- **Do not look at the sun or strong lights with the camera.**
- **Do not use or store the camera in dusty or humid places.**
- **Do not cover the flash with a hand while firing.**
- **Do not insert anything into the microSD Attachment other than the microSD card.** Other types of cards cannot be installed on this microSD Attachment.
- **Do not insert anything other than an xD-Picture Card or the microSD Attachment into the camera.**

If you insert a card by mistake, such as a microSD card, do not use force. Contact authorized distributors/service centers.

### CAUTION

- **Stop using the camera immediately if you notice any unusual odors, noise or smoke around it.**
  - Never remove the batteries with bare hands, which may cause a fire or burn your hands.
- **Never hold or operate the camera with wet hands.**
- **Do not leave the camera in places where it may be subject to extremely high temperatures.**
  - Doing so may cause parts to deteriorate and, in some circumstances, cause the camera to catch fire. Do not use the charger or AC adapter if it is covered (such as a blanket). This could cause overheating, resulting in fire.
- **Handle the camera with care to avoid getting a low-temperature burn.**
  - When the camera contains metal parts, overheating can result in a low-temperature burn. Pay attention to the following:
    - When used for a long period, the camera will get hot. If you hold on to the camera in this state, a low-temperature burn may be caused.
    - In places subject to extremely cold temperatures, the temperature of the camera's body may be lower than the environmental temperature. If possible, wear gloves when handling the camera in cold temperatures.
- **Be careful with the strap.**
  - Be careful with the strap when you carry the camera. It could easily catch on stray objects and cause serious damage.

## Battery Handling Precautions

Follow these important guidelines to prevent batteries from leaking, overheating, burning, exploding or causing electrical shocks or burns.

### DANGER

- Use only the Olympus brand NiMH batteries and proper fitting charger.
- Never heat or incinerate batteries.
- Take precautions when carrying or storing batteries to prevent them from coming into contact with any metal objects such as jewelry, pins, fasteners, etc.
- Never store batteries where they will be exposed to direct sunlight, or subjected to high temperatures in a hot vehicle, near a heat source, etc.
- To prevent causing battery leaks or damaging their terminals, carefully follow all instructions regarding the use of batteries. Never attempt to disassemble a battery or modify it in any way, solder, etc.
- If battery fluid gets into your eyes, flush your eyes immediately with clear, cold running water and seek medical attention immediately.
- Always store batteries out of the reach of small children. If a child accidentally swallows a battery, seek medical attention immediately.

### WARNING

- Keep batteries dry at all times.
- To prevent batteries from leaking, overheating or causing a fire or explosion, use only batteries recommended for use with this product.
- Never mix batteries (old and new batteries, charged and uncharged batteries, batteries of different manufacture or capacity, etc.).
- Never attempt to charge alkaline, lithium or CR-V3 lithium battery packs.
- Insert the battery carefully as described in the operating instructions.
- Do not use batteries if their body is not covered by the insulating sheet or if the sheet is torn, as this may cause fluid leaks, fire or injury.

### CAUTION

- Do not remove batteries immediately after using the camera. Batteries may become hot during prolonged use.
- Always unload the battery from the camera before storing the camera for a long period.

The following AA (R6) batteries cannot be used.

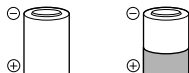

Batteries whose bodies are only partially or not at all covered by an insulating sheet.



Batteries whose  $\ominus$  terminals are raised, but not covered by an insulating sheet.

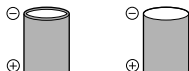

Batteries whose  $\ominus$  terminals are flat and not completely covered by an insulating sheet. (Such batteries cannot be used even if the  $\ominus$  terminals are partially covered.)

- If NiMH batteries are not charged within the specified time, stop charging them and do not use them.
- Do not use a battery if it is cracked or broken.
- If a battery leaks, becomes discolored, deformed or becomes abnormal in any other way during operation, stop using the camera.
- If a battery leaks fluid onto your clothing or skin, remove the clothing and flush the affected area with clean, running cold water immediately. If the fluid burns your skin, seek medical attention immediately.
- Never subject batteries to strong shocks or continuous vibration.

## Caution for Usage Environment

- To protect the high-precision technology contained in this product, never leave the camera in the places listed below, no matter if in use or storage:
  - Places where temperatures and/or humidity are high or go through extreme changes. Direct sunlight, beaches, locked cars, or near other heat sources (stove, radiator, etc.) or humidifiers.
  - In sandy or dusty environments.
  - Near flammable items or explosives.
  - In wet places, such as bathrooms or in the rain. When using products with weatherproof designs, read their manuals as well.
  - In places prone to strong vibrations.
- Never drop the camera or subject it to severe shocks or vibrations.
- When mounted on a tripod, adjust the position of the camera with the tripod head. Do not twist the camera.
- Do not touch electric contacts on cameras.
- Do not leave the camera pointed directly at the sun. This may cause lens or shutter curtain damage, color failure, ghosting on the CCD, or may possibly cause fires.
- Do not push or pull severely on the lens.
- Before storing the camera for a long period, remove the batteries. Select a cool, dry location for storage to prevent condensation or mold from forming inside the camera. After storage, test the camera by turning it on and pressing the shutter button to make sure that it is operating normally.
- Always observe the operating environment restrictions described in the camera's manual.

## Battery Handling Precautions

- Olympus NiMH batteries (included in some areas) are intended for use only with Olympus digital cameras. Never use these batteries with any other device.
- Always charge NiMH batteries (included in some areas) before using them for the first time, or if they have not been used for a long period.
- Always charge sets of batteries (included in some areas) (2 or 4) together.
- Do not use alkaline batteries unless it is absolutely necessary. In some cases, alkaline batteries may have a shorter service life than NiMH. Alkaline battery performance is limited, especially at low temperatures. The use of NiMH batteries is recommended.
- AA manganese (Zinc-Carbon) batteries cannot be used with this camera.
- When operating the camera with battery power at low temperatures, try to keep the camera and spare batteries as warm as possible. Batteries which run down at low temperatures may be restored after they are warmed at room temperature.
- Recommended temperature ranges for NiMH batteries:

Operation .....	0°C to 40°C (32°F to 104°F)
Charge .....	0°C to 40°C (32°F to 104°F)
Storage.....	-20°C to 30°C (-4°F to 86°F)
- Using, charging or storing the batteries outside these ranges could shorten battery life or affect battery performance. Always unload the batteries from the camera before storing the camera for a long period.
- Before using NiMH or NiCd batteries, always read the provided instructions.
- The number of pictures you can take may vary depending on the shooting conditions or batteries.
- Before going on a long trip, and especially before traveling abroad, purchase an ample supply of extra batteries. The recommended batteries may be difficult to obtain while traveling.
- Please recycle batteries to help save our planet's resources. When you throw away dead batteries, be sure to cover their terminals and always observe local laws and regulations.

## LCD Monitor

- Do not push the monitor forcibly; otherwise the image may become vague, resulting in a playback mode failure or damage to the monitor.
- A strip of light may appear on the top/bottom of the monitor, but this is not a malfunction.
- When a subject is viewed diagonally in the camera, the edges may appear zigzagged on the monitor. This is not a malfunction; it will be less noticeable in playback mode.
- In places subject to low temperatures, the LCD monitor may take a long time to turn on or its color may change temporarily. When using the camera in extremely cold places, it is a good idea to occasionally place it in a warm place. An LCD monitor exhibiting poor performance due to low temperatures will recover in normal temperatures.
- The LCD used for the monitor is made with high-precision technology. However, black spots or bright spots of light may appear constantly on the LCD Monitor. Due to its characteristics or the angle at which you are viewing the monitor, the spot may not be uniform in color and brightness. This is not a malfunction.

## Legal and Other Notices

- Olympus makes no representations or warranties regarding any damages or benefit expected by using this unit lawfully, or any request from a third person, which are caused by the inappropriate use of this product.
- Olympus makes no representations or warranties regarding any damages or any benefit expected by using this unit lawfully which are caused by erasing picture data.

## Disclaimer of Warranty

- Olympus makes no representations or warranties, either expressed or implied, by or concerning any content of these written materials or software, and in no event shall be liable for any implied warranty of merchantability or fitness for any particular purpose or for any consequential, incidental or indirect damages (including but not limited to damages for loss of business profits, business interruption and loss of business information) arising from the use or inability to use these written materials or software or equipment. Some countries do not allow the exclusion or limitation of liability for consequential or incidental damages, so the above limitations may not apply to you.
- Olympus reserves all rights to this manual.

## Warning

Unauthorized photographing or use of copyrighted material may violate applicable copyright laws. Olympus assumes no responsibility for unauthorized photographing, use or other acts that infringe upon the rights of copyright owners.

## Copyright Notice

All rights reserved. No part of these written materials or this software may be reproduced or used in any form or by any means, electronic or mechanical, including photocopying and recording or the use of any type of information storage and retrieval system, without the prior written permission of Olympus. No liability is assumed with respect to the use of the information contained in these written materials or software, or for damages resulting from the use of the information contained therein. Olympus reserves the right to alter the features and contents of this publication or software without obligation or advance notice.

## For customers in Europe



"CE" mark indicates that this product complies with the European requirements for safety, health, environment and customer protection. "CE" mark cameras are intended for sales in Europe.



This symbol [crossed-out wheeled bin WEEE Annex IV] indicates separate collection of waste electrical and electronic equipment in the EU countries. Please do not throw the equipment into the domestic refuse.

Please use the return and collection systems available in your country for the disposal of this product.



This symbol [crossed-out wheeled bin Directive 2006/66/EC Annex II] indicates separate collection of waste batteries in the EU countries. Please do not throw the batteries into the domestic refuse. Please use the return and collection systems available in your country for the disposal of the waste batteries.

### Provisions of warranty

- 1 If this product proves to be defective, although it has been used properly (in accordance with the written Handling Care and Operating instructions supplied with it), during a period of two years from the date of purchase from an authorized Olympus distributor within the business area of Olympus Imaging Europa GmbH as stipulated on the website: <http://www.olympus.com> this product will be repaired, or at Olympus's option replaced, free of charge. To claim under this warranty, the customer must take the product and this Warranty Certificate before the end of the two-year warranty period to the dealer where the product was purchased or any other Olympus service station within the business area of Olympus Imaging Europa GmbH as stipulated on the website: <http://www.olympus.com>. During the one-year period of the World Wide Warranty the customer may turn the product in at any Olympus service station. Please note that Olympus service stations do not exist in all countries.
- 2 The customer shall transport the product to the dealer or Olympus authorized service station at his own risk and shall be responsible for any costs incurred in transporting the product.
- 3 This warranty does not cover the following and the customer will be required to pay repair charge, even for defects occurring within the warranty period referred to above.
  - a. Any defect that occurs due to mishandling (such as an operation performed that is not mentioned in the Safety Precautions or other sections of the instructions, etc.)
  - b. Any defect that occurs due to repair, modification, cleaning, etc. performed by anyone other than Olympus or an Olympus authorized service station.
  - c. Any defect or damage that occurs due to transport, a fall, shock, etc. after purchase of the product.
  - d. Any defect or damage that occurs due to fire, earthquake, flood damage, thunderbolt, other natural disasters, environmental pollution and irregular voltage sources.
  - e. Any defect that occurs due to careless or improper storage (such as keeping the product under conditions of high temperature and humidity, near insect repellents such as naphthalene or harmful drugs, etc.), improper maintenance, etc.
  - f. Any defect that occurs due to exhausted batteries, etc.
  - g. Any defect that occurs due to sand, mud, etc. entering the inside of the product casing.
  - h. When this Warranty Certificate is not returned with the product.
  - i. When any alterations whatsoever are made to the Warranty Certificate regarding the year, month and date of purchase, the customer's name, the dealer's name and the serial number.
  - j. When proof of purchase is not presented with this Warranty Certificate.
- 4 This Warranty applies to the product only; the Warranty does not apply to any other accessory equipment, such as the case, strap, lens cap and batteries.
- 5 Olympus's sole liability under this warranty shall be limited to repairing or replacing the product. Any liability for indirect or consequential loss or damage of any kind incurred or suffered by the customer due to a defect of the product, and in particular any loss or damage caused to any lenses, films, other equipment or accessories used with the product or for any loss resulting from a delay in repair or loss of data, is excluded. Compelling regulations by law remain unaffected by this.



## Notes regarding warranty maintenance

- 1 This warranty will only be valid if the Warranty Certificate is duly completed by Olympus or an authorized dealer or other documents contain sufficient proof. Therefore, please make sure that your name, the name of the dealer, the serial number and the year, month and date of purchase are all completed or the original invoice or the sales receipt (indicating the dealer's name, the date of purchase and product type) is attached to this Warranty Certificate. Olympus reserves the right to refuse free-of-charge service if neither Warranty Certificate is completed nor the above document is attached or if the information contained in it is incomplete or illegible.
  - 2 Since this Warranty Certificate will not be re-issued, keep it in a safe place.
- \* Please refer to the list on the website: <http://www.olympus.com> for the authorized international Olympus service network.

## Trademarks

- IBM is a registered trademark of International Business Machines Corporation.
- Microsoft and Windows are registered trademarks of Microsoft Corporation.
- Macintosh is a trademark of Apple Inc.
- xD-Picture Card™ is a trademark.
- microSD is a trademark of the SD Association.
- All other company and product names are registered trademarks and/or trademarks of their respective owners.
- The standards for camera file systems referred to in this manual are the "Design rule for Camera File system/DCF" standards stipulated by the Japan Electronics and Information Technology Industries Association (JEITA).

HDMI, the HDMI Logo and High-Definition Multimedia Interface are trademarks or registered trademarks of HDMI Licensing LLC.

**HDMI**™  
HIGH-DEFINITION MULTIMEDIA INTERFACE

## SPECIFICATIONS

### Camera

<b>Product type</b>	: Digital camera (for shooting and displaying)
<b>Recording system</b>	
<b>Still pictures</b>	: Digital recording, JPEG (in accordance with Design rule for Camera File system (DCF))
<b>Applicable standards</b>	: Exif 2.2, Digital Print Order Format (DPOF), PRINT Image Matching III, PictBridge
<b>Sound with still pictures</b>	: Wave format
<b>Movie</b>	: AVI Motion JPEG
<b>Memory</b>	: Internal memory xD-Picture Card (16 MB - 2 GB) (TypeH/M/M+, Standard) microSD card/microSDHC card (when using the attached microSD Attachment)
<b>No. of effective pixels</b>	: 12,000,000 pixels
<b>Image pickup device</b>	: 1/2.33" CCD (primary color filter), 12,470,000 pixels (gross)
<b>Lens</b>	: Olympus lens 4.6 to 119.6 mm, f2.8 to 5.0 (equivalent to 26 to 676 mm on a 35 mm camera)
<b>Photometric system</b>	: Digital ESP metering, spot metering, center weighted metering
<b>Shutter speed</b>	: 15 to 1/2000 sec. (During bulb: Max. 8 minutes)
<b>Aperture</b>	: F2.8 to F8.0
<b>Shooting range</b>	: 0.1 m (3.9 in.) to ∞ (W) 1.7 m (66.9 in.) to ∞ (T) (normal/macro mode) 0.01 m (0.4 in.) to ∞ (super macro mode)
<b>Monitor</b>	: 2.7" TFT color LCD display, 230,000 dots
<b>Connector</b>	: DC-IN jack, Multi-connector (USB connector, A/V OUT jack), HDMI mini connector
<b>Automatic calendar system</b>	: 2000 up to 2099
<b>Operating environment</b>	
<b>Temperature</b>	: 0 °C to 40 °C (32 °F to 104 °F) (operation) / -20 °C to 60 °C (-4 °F to 140 °F) (storage)
<b>Humidity</b>	: 30 % to 90 % (operation)/10 % to 90 % (storage)
<b>Power supply</b>	: AA alkaline / NiMH battery (four) or Olympus AC adapter
<b>Dimensions</b>	: 110.1 mm (W) × 89.7 mm (H) × 91.0 mm (D) (4.3 × 3.5 × 3.6 in.) (excluding protrusions)
<b>Weight</b>	: 435 g (15.3 oz) without batteries and card

### microSD Attachment





<b>Product type</b>	: Attachment for microSD
<b>Environment</b>	
<b>Temperature</b>	: -10 °C to 40 °C (14 °F to 104 °F) (operation) / -20 °C to 65 °C (-4 °F to 149 °F) (storage)
<b>Humidity</b>	: 95% and below (operation) / 85% and below (storage)
<b>Dimensions</b>	: 25.0 mm (W) × 20.3 mm (H) × 1.7 mm (D) (1.0 × 0.8 × 0.07 in.) (Handle: 2.2 mm (0.09 in.))
<b>Weight</b>	: Approx. 0.9 g (0.03 oz)

Design and specifications subject to change without notice.

## Names of Parts..... 6

 RC.....	36, 74
 VOLUME.....	51
 FLASH.....	36
<b>SCN</b> (Scene).....	17, 40







## A

AC adapter.....	72
Adding sound to still pictures  .....	48
AE LOCK <b>(AEL)</b> .....	26
AF ILLUMINAT.....	35
AF LOCK <b>(AFL)</b> .....	26
AF MODE.....	34
AF PREDICT  .....	35
AF sequential shooting  .....	32
AF target mark.....	14, 26, 34
ALL (PERFECT FIX).....	44
ALL ERASE.....	49
ALL INDEX.....	59
ALL PRINT.....	59
All-frame reservation  .....	62
Aperture priority mode <b>A</b> .....	18
Aperture value.....	17, 18, 19
AREA.....	34
AUTO (full automatic) <b>AUTO</b> .....	14
AUTO (ISO).....	31
AUTO (white balance) <b>WB AUTO</b> .....	30
Auto focus.....	68
AV cable.....	2, 55



## B

BACKUP.....	50
Batteries.....	10, 71
BEAUTY.....	19
BEAUTY FIX.....	45
BEEP.....	51
BGM (SLIDESHOW).....	44
BKT.....	32
Bracket shooting.....	32

## C

CALENDAR (edit).....	46
Calendar view.....	27
CAMERA MENU.....	30
Card.....	11, 50, 72
Center-weighted metering  .....	33
CLEAR SKIN.....	45
Closeup view  .....	27
Cloudy day  .....	30
COLOR EDIT.....	46
COMBINE IN CAMERA1/2.....	42
COMBINE IN PC.....	42
COMPRESSION.....	29, 73
Continuous recording length.....	73
CONTRAST  .....	38
Conversion lens  .....	39
Cropping (PictBridge).....	60
Cropping  .....	45
CURRENT (MY MODE SETUP).....	56
CUSTOM BUTTON.....	26, 57
CUSTOM PRINT.....	59









## D

Date and time  .....	12, 54
DIGITAL ZOOM.....	33
Direct printing.....	58
DIRECT (Histogram).....	56
DPOF.....	61
DRAMATIC EYE.....	45
DRIVE.....	32
DUALTIME  .....	54



## E

EASY PRINT.....	58
EDIT.....	45, 47
Elapsed time.....	16
ERASE.....	49
Error message.....	67
ESP.....	33
Exposure.....	23
Exposure compensation  .....	23

**F**

FACE DETECT .....	34
FACE FOCUS .....	46
FILE NAME .....	53, 60
Fill-in flash  .....	23
FINE FINE  .....	29, 73
FINE ZOOM .....	33
FLASH AUTO .....	23
Flash intensity control  .....	36
Flash mode  .....	22
Flash off  .....	23
Fluorescent lamp 1/2/3    .....	30
Focus .....	14, 68
FOCUS MODE .....	34
FORMAT .....	50
FRAME RATE .....	29, 73
FULLTIME AF .....	35
FUNC menu .....	26

**H**

HDMI .....	56
HIGH ISO AUTO (ISO) .....	31
High speed sequential shooting 1/2   .....	32
Histogram  .....	27, 56

**I**

iESP .....	34
IMAGE QUALITY .....	29
IMAGE SIZE .....	29, 73
IMAGE STABILIZER  .....	35
IN .....	36
INDEX .....	47
INDEX PLAY .....	48
Index view .....	27
Information displays .....	25, 27
Internal memory .....	72
ISO .....	31

**L**



LIVE VIEW BOOST .....	52
-----------------------	----

**M**

m/ft .....	57
Macro mode  .....	24

Macro shooting .....	24
Manual mode <b>M</b> .....	19
MEMORY FORMAT .....	50
MENU COLOR .....	51
MENU DISPLAY .....	52
Menu guide .....	3
METERING .....	33
microSD .....	11, 74
Monitor brightness adjustment  .....	54
MOVIE INDEX .....	47
MULTI PRINT .....	59
MY MODE SETUP My1/2/3/4 .....	56



**N**

NATURAL .....	37
NOISE REDUCT. (NR) .....	38
NORMAL  .....	29, 73
NTSC .....	55
Number of prints  .....	60
Number of storable still pictures .....	73

**O**







OLYMPUS Master 2 .....	64
Olympus Wireless RC Flash System .....	74
One-touch WB  .....	30
Optical zoom .....	21

**P**















PAL .....	55
PANORAMA .....	42
Panorama playback .....	28
PC .....	64
PERFECT FIX .....	44
PIC ORIENTATION .....	54
PictBridge .....	58
PICTURE MODE .....	37
PIXEL MAPPING .....	53
PLAYBACK MENU .....	48
Playback mode  .....	5, 15
Playback on a TV .....	55
PRE-CAPTURE  .....	32
PRESET (WB) .....	30
Press fully .....	15
Press halfway .....	14
PRINT ORDER .....	59
PRINT ORDER  .....	49



Print reservations.....	61
Program mode <b>P</b> .....	17
Protect <b>On</b> .....	48
PW ON SETUP.....	51

## R



REC VIEW.....	52
Recording sound with movies  .....	39
Recording sound with still pictures  .....	37
Red-eye fill-in flash  .....	23
REDEYE FIX.....	44
Red-eye reduction flash  .....	23
RESET.....	43
RESET (MY MODE SETUP).....	56
Resizing  .....	45
Rotating images  .....	48

## S

SATURATION  .....	38
SEL. IMAGE.....	49
Selecting a language  .....	13, 50
Self-timer  .....	24
Sequential playback.....	28
Sequential shooting  .....	32
SHADOW ADJ.....	44
Shadow adjustment technology  .....	22
SHARPNESS  .....	37
Shooting mode.....	4, 17
Shooting movies  .....	20
Shutter priority mode <b>S</b> .....	18
SHUTTER SOUND.....	51
Shutter speed.....	17, 18, 19
SILENT MODE  .....	57
Single image erase.....	16
Single-frame reservation  .....	61
Single-frame shooting  .....	32
SLAVE.....	36
SLEEP.....	57
Sleep mode.....	57, 66
SLIDESHOW.....	44
Slow synchronization  <small>SLOW1</small> ,  <small>SLOW2</small> .....	23
Slow synchronization/Red-eye reduction flash  .....	23
SOUND SETTINGS.....	51
SPARKLE EYE.....	45
SPOT (AF MODE).....	34
Spot metering  .....	33

STANDARD.....	58
Strap.....	2, 10
Sunny day  .....	30
Super macro mode  .....	24

## T

TIMELAPSE  .....	39
Top menu.....	4, 5
Total recording time.....	16
Tungsten light  .....	30
TYPE (SLIDESHOW).....	44



## U

USB cable.....	2, 58, 64
----------------	-----------

## V

VIDEO OUT.....	55
VIVID.....	37

## W

Warning sound  .....	51
WB.....	30
White balance compensation  .....	37

## X

xD-Picture Card.....	11, 72
----------------------	--------

## Z

Zoom.....	21, 33
-----------	--------

# OLYMPUS®

<http://www.olympus.com/>

## OLYMPUS IMAGING CORP.

Shinjuku Monolith, 3-1 Nishi-Shinjuku 2-chome, Shinjuku-ku, Tokyo, Japan

## OLYMPUS IMAGING AMERICA INC.

3500 Corporate Parkway, P.O. Box 610, Center Valley, PA 18034-0610, U.S.A. Tel. 484-896-5000

### Technical Support (USA)

24/7 online automated help: <http://www.olympusamerica.com/support>

Phone customer support: Tel. 1-888-553-4448 (Toll-free)

Our phone customer support is available from 8am to 10pm

(Monday to Friday) and 9am to 5pm (Sunday) ET

<http://olympusamerica.com/contactus>

Olympus software updates can be obtained at: <http://www.olympusamerica.com/digital>

## OLYMPUS IMAGING EUROPA GMBH

Premises: Wendenstrasse 14-18, 20097 Hamburg, Germany

Tel: +49 40-23 77 3-0 / Fax: +49 40-23 07 61

Goods delivery: Bredowstrasse 20, 22113 Hamburg, Germany

Letters: Postfach 10 49 08, 20034 Hamburg, Germany

### European Technical Customer Support:

Please visit our homepage <http://www.olympus-europa.com>

or call our TOLL FREE NUMBER\* : **00800 - 67 10 83 00**

for Austria, Belgium, Denmark, Finland, France, Germany, Italy, Luxembourg, Netherlands, Norway, Portugal, Spain, Sweden, Switzerland, United Kingdom

\* Please note some (mobile) phone services providers do not permit access or request an additional prefix to +800 numbers.

For all European Countries not listed and in case that you can't get connected

to the above mentioned number, please make use of the following

CHARGED NUMBERS: **+49 180 5 - 67 10 83** or **+49 40 - 237 73 4899**

Our Technical Customer Support is available from 9 am to 6 pm MET (Monday to Friday)