

DIGITAL CAMERA

SP-700

Advanced Manual

Detailed explanations of all the functions for getting the most out of your camera.

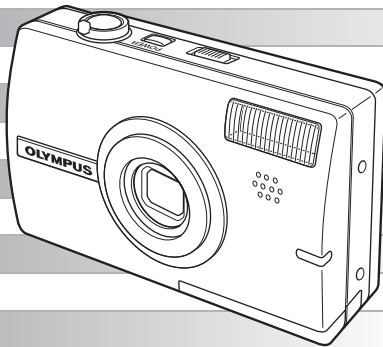

Basic Operation

Basic Shooting

Advanced Shooting

Playing Back

Printing

Online Pictures

Camera Settings

- Thank you for purchasing an Olympus digital camera. Before you start to use your new camera, please read these instructions carefully to enjoy optimum performance and a longer service life. Keep this manual in a safe place for future reference.
- We recommend that you take test shots to get accustomed to your camera before taking important photographs.
- In the interest of continually improving products, Olympus reserves the right to update or modify information contained in this manual.

How to use this manual

● Basic and Advanced Manuals

The instruction manual accompanying this camera is divided into two parts: the Basic Manual and the Advanced Manual (this document).

Basic Manual This manual gives you easy-to-follow explanations on how to take pictures and view them so that you can get started quickly. Go ahead and take some pictures! You will also find information on the camera's main functions as well as how to make prints and enjoy your pictures on a computer.

Advanced Manual This manual introduces you to the camera's many functions after you have mastered the basics. It will help you to use the camera's capabilities to take much more creative pictures, with more fun!

● Indications used in this manual

Below is an explanation of how to read the instructions in this manual. Please read it carefully before proceeding.



Note

Important information on factors which may lead to a malfunction or operational problems. Also warns of operations that should be absolutely avoided.



TIPS

Useful information and hints that will help you get the most out of your camera.



Reference pages describing details or associated information.

Composition of the manual

You'll find important points for getting the most out of your camera here. Read this part before taking pictures.

Explanations of techniques from basics to advanced, giving you an understanding of all the functions related to taking pictures.

To view, edit and sort the pictures you have taken.

Settings to make your camera easier to use.

To print the pictures you have taken.

To enjoy the pictures you have taken on a computer. To use OLYMPUS Master.

Troubleshooting. For when you want to know the names of parts, see a list of menus, or find what you are looking for.

Basic operation P. 8

Tips before you start taking pictures P. 23

Basic shooting functions P. 34

Additional shooting functions P. 49

Playback P. 64

Settings P. 97

Printing pictures P. 114

Connecting the camera to a computer P. 130

Appendix P. 146

Miscellaneous P. 165

1

2

3

4

5

6

7

8

9

10

The title page of each chapter gives a short description of the contents. Be sure to check it out.



Table of Contents

How to use this manual.....	2
Composition of the manual	3







1 Basic operation - - - - -8

How to use the mode switch	9
Direct buttons.....	12
Using the direct buttons in shooting mode.....	12
Using the direct buttons in playback mode	13
Menus	14
About the menus	14
Using the menus	19
Using the GUIDE function.....	21
How to read the procedure pages.....	22







2 Tips before you start taking pictures - - - - -23

If the correct focus cannot be obtained.....	24
How to focus (focus lock).....	24
Subjects that are difficult to focus on	25
Record mode (IMAGE QUALITY) 	26
Still picture record modes.....	26
Movie record modes.....	27
Number of storable still pictures/remaining recording time	27
Changing the record mode 	29
The internal memory and memory card	30
The card.....	31
Inserting and removing the card.....	32

















3 Basic shooting functions- - - - -34







Selecting a scene according to the situation (SCENE).....	35
Zooming in on your subject.....	40
Using the zoom	40
Using the digital zoom.....	41
Using macro/super macro mode  	42
Flash shooting 	43
Self-timer shooting 	45
Recording movies 	46
Camera movement compensation (IMAGE STABILIZER) 	47
Fulltime AF.....	48
Recording sound with movies 	48

4 Additional shooting functions - - - - -49







Shoot pictures while checking the shot you just took (COMPARE & SHOOT) 	50
Changing ISO sensitivity (ISO) 	51
Changing picture brightness (EXP. COMP.) 	52
Adjusting the color of a picture (WHITE BALANCE) WB	53
Changing the area for measuring the brightness of a subject (METERING).....	54
Sequential shooting ( /MULTI-SHOT) 	55
Changing the focusing area (AF MODE)	56
Panorama shooting.....	57
Creating labels for combined LABEL (LABEL SHOT).....	59
Recording sound with still pictures 	60
Changing the monitor display (DISP./GUIDE)	61
Histogram 	62
Frame assist.....	63

5 Playback - - - - -64

Playing back still pictures 	65
Playing back pictures in a calendar (CALENDAR) 	66
Picture rotation (ROTATION) 	66
Playing back movies 	67
Selecting the position to begin movie playback (INDEX PLAY) 	68
Playing back albums 	69
Adding pictures to an album (ALBUM ENTRY).....	70
Viewing pictures in albums.....	72
Selecting an album cover (SELECT TITLE IMAGE) 	73
Undoing album entries (UNDO ENTRY) 	73
Erasing pictures from albums 	75
Slideshow 	76
Adding sound to still pictures 	77
Editing still pictures ( /  /REDEYE FIX/BLACK & WHITE/SEPIA) 	78
Creating composite pictures (FRAME/LABEL/CALENDAR/ LAYOUT) 	80
Adjusting pictures (BRIGHTNESS, SATURATION, COLOR BALANCE, WARM/COOL) 	84
Editing movies 	85
Creating an index.....	86
Editing a movie.....	87



Playing back pictures on a TV.....	89
Video output.....	90
Protecting pictures (PROTECT) 	91
Copying pictures in the internal memory to the card (BACKUP).....	92
Erasing pictures  	93
Single-frame erase 	93
Erase selected.....	94
All-frame erase 	95
Formatting the internal memory/card (MEMORY FORMAT/ FORMAT)  	96

6 Settings - - - - - 97

Resetting the settings to the default (RESET) 	98
Selecting a display language 	99
Changing the startup screen and shutdown screen (PW ON SETUP/PW OFF SETUP).....	100
Screen setup.....	101
Viewing pictures immediately (REC VIEW).....	102
Setting camera sounds (■)/BEEP/SHUTTER SOUND/ VOLUME).....	103
Resetting file names (FILE NAME).....	105
Adjusting the image processing function (PIXEL MAPPING).....	106
Adjusting the monitor brightness 	107
Setting the date and time 	107
Setting the date and time in another time zone (DUAL TIME SETUP) 	108
Displaying a picture automatically (SCREEN SAVER).....	110
Setting the sleep time (SLEEP).....	111
Custom button 	112
Setting the custom button.....	113
Using the custom button.....	113

7 Printing pictures - - - - - 114

Direct printing (PictBridge).....	115
Using the direct printing function.....	115
Printing pictures (EASY PRINT).....	116
Printing pictures (CUSTOM PRINT).....	118
Other print modes and print settings.....	121
If an error message is displayed.....	124
Print settings (DPOF) 	125

How to make print reservations.....	125
Single-frame reservation 	127
All-frame reservation 	128
Resetting print reservation data 	129

8 Connecting the camera to a computer - - - - 130

Flow.....	131
Using OLYMPUS Master	132
What is OLYMPUS Master?.....	132
Installing OLYMPUS Master	133
Connecting the camera to a computer	137
Starting up OLYMPUS Master	138
Displaying camera images on a computer	140
Downloading and saving images	140
Viewing still pictures and movies	142
Printing pictures	143
To download and save images to a computer without using OLYMPUS Master.....	145

9 Appendix - - - - - 146

Troubleshooting	147
Error messages.....	147
Troubleshooting	149
Camera care	156
Battery.....	157
AC adapter	158
Safety Precautions.....	159
Glossary of terms	163

10 Miscellaneous - - - - - 165

Menu list.....	166
List of factory default settings.....	175
Functions available in shooting modes and scenes.....	177
Index	183

Basic operation

Are you ever overwhelmed by all of the advanced shooting and editing functions? Professional photographers use these functions to achieve a variety of effects. Now you too can achieve such effects simply by pressing the buttons on your digital camera. You can use the various functions available to adjust the brightness and white balance of your pictures, alter the focusing range, and much more.

Just display a menu on the monitor and use the buttons to choose a setting. Familiarize yourself with the buttons and menus before reading the explanations of the various functions.

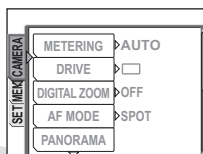
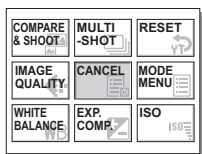

Movies

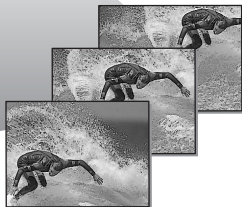



Sequential shooting

How to use the mode switch

This camera features a shooting mode and a playback mode. Shooting mode is for taking pictures and adjusting shooting settings, whereas playback mode is for displaying and editing pictures you have taken. To switch between the shooting mode and the playback mode slide the mode switch.

Shooting modes

Set the mode switch to  to take still pictures or  to record movies.

Playback mode

Set the mode switch to this position to view pictures.

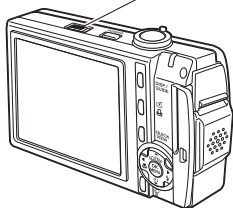

To take pictures (shooting mode)



- The subject is displayed on the monitor.

Set to .



To play back (playback mode)

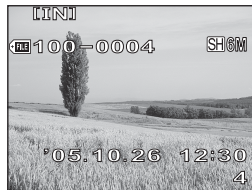

- The last picture taken is displayed on the monitor.

Set to  or .





Mode switch notation

In this manual, the following icons indicate the camera mode necessary for using functions. If two or three icons are displayed, the described function can be used in any of those modes. The icons for modes that cannot be used are shown in gray.



This indicates an operation when the mode switch is set to .



This indicates an operation when the mode switch is set to ,  or .

● Turning the camera on in shooting mode

Set the mode switch to  or  and press the **POWER** button.

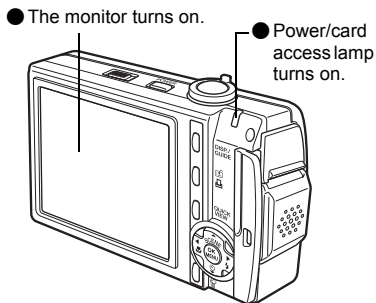
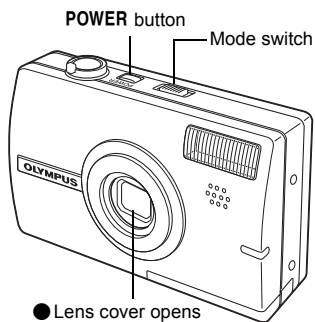

- The camera turns on in shooting mode. You are ready to take pictures.



To turn the camera off

→ Press the **POWER** button. The lens cover closes and the monitor and the power/card access lamp turn off.

To switch to playback mode

→ Set the mode switch to . The camera is in playback mode while the lens cover remains open. To return to shooting mode, set the mode switch to  or .

● Turning the camera on in playback mode

Set the mode switch to  and press the **POWER** button.

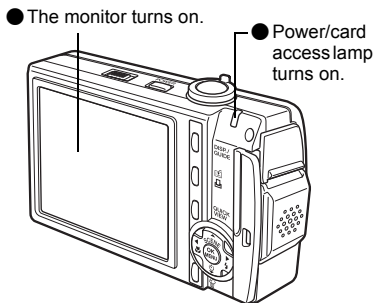
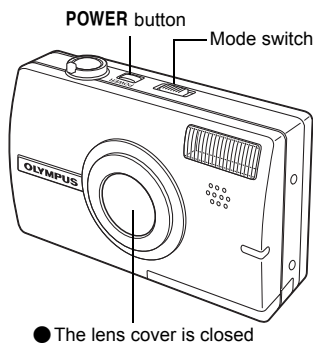

- The camera turns on in playback mode. The last picture taken is displayed on the monitor.



To turn the camera off

→ Press the **POWER** button. The monitor and the power/card access lamp turn off.

To switch to shooting mode

→ Set the mode switch to  or . The lens cover opens and shooting mode is enabled. To return to playback mode, set the mode switch to . The lens cover remains open.

! Note

- When the power is turned on, sometimes the monitor flashes before displaying the picture. This is not a malfunction.

? TIPS

- The screen on the right is displayed when the date and time setting has returned to the factory default setting. Setting the date and time makes your pictures easier to manage, such as when you view them with calendar display.
 "Setting the date and time" (P. 107)



Direct buttons

This camera features buttons for setting functions directly. The direct buttons have different functions in shooting mode and in playback mode.

Using the direct buttons in shooting mode

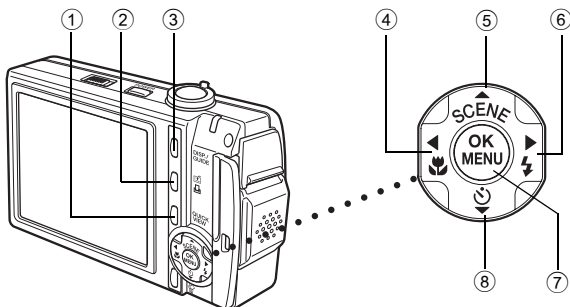

- ① **QUICK VIEW** button 👉 P. 65

The last picture taken is displayed on the monitor. All the functions in playback mode are available. To return to shooting mode, press the **QUICK VIEW** button again or press the shutter button halfway.

- ②  (custom) button 👉 P. 112

Activates the function that is selected for the custom button.

- ③ **DISP./GUIDE** button 👉 P. 21, 61

Select a menu item, and press this button to display an explanation of its function. When the camera is ready to shoot, press this button repeatedly to toggle the display of shooting information, composition guide lines and histogram.

- ④  button (Macro) 👉 P. 42

Enables macro mode or super macro mode.

- ⑤  **SCENE** (SCENE SELECT) button 👉 P. 38

Select the scene mode best suited to the light conditions and the effect you want to achieve.

- ⑥  button (Flash mode) 👉 P. 43

Selects the flash mode.

- ⑦  button (OK/MENU) 👉 P. 14

Displays the top menu of shooting mode.

- ⑧  button (Self-timer) 👉 P. 45

Switches the self-timer mode on/off

Using the direct buttons in playback mode

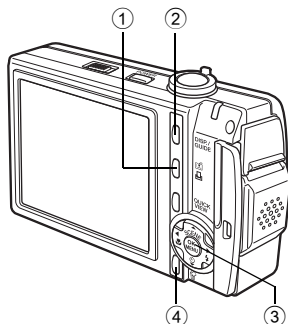

- ① button (Print) P. 116

Prints pictures displayed on the monitor.

- ② **DISP./GUIDE** button P. 21

Select a menu item, and press this button to display an explanation of its function. During playback, press this button repeatedly to change the display in the following order.

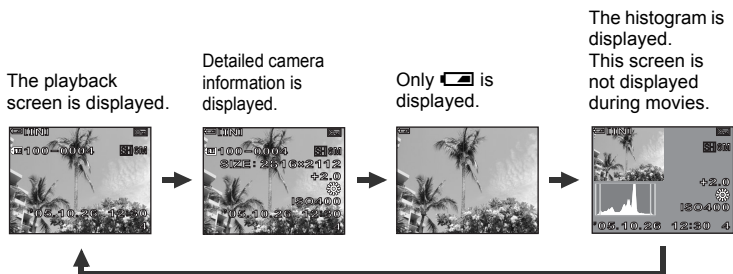

- ③ button (OK/MENU) P. 14

Displays the top menu of playback mode.

- ④ button (Erase) P. 75, 93

Erases pictures displayed on the monitor.

Menus

Press  in shooting mode or playback mode to display the menus on the monitor. Menus are used to select each camera setting.

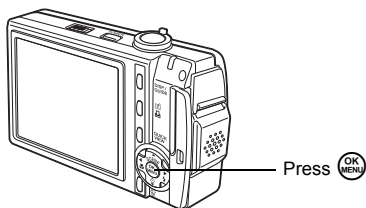

About the menus

The menu items displayed in shooting mode and playback mode differ.

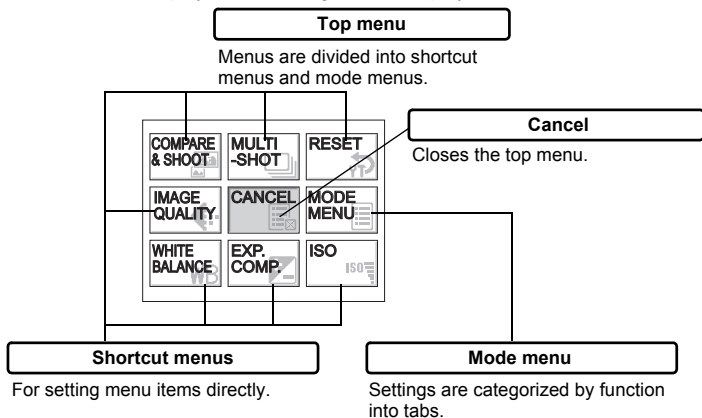

Shortcut menus

● Shooting mode

For still pictures

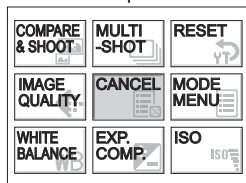

For movies

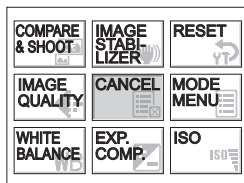

Menu items for taking pictures	Ref. Page
COMPARE & SHOOT	P. 50
MULTI-SHOT (for still pictures)	P. 55
IMAGE STABILIZER (for movies)	P. 47
RESET	P. 98
IMAGE QUALITY	P. 26 P. 27
CANCEL	P. 14
MODE MENU	P. 18
WHITE BALANCE	P. 53
EXP. COMP.	P. 52
ISO	P. 51

● Playback mode

For still pictures

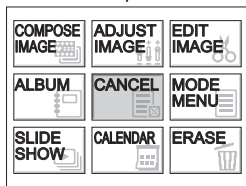

For movies

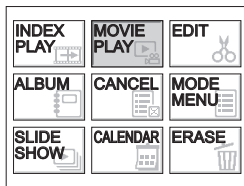

Menu items for taking pictures	Ref. Page
COMPOSE IMAGE (for still pictures)	P. 80
INDEX PLAY (for movies)	P. 68
ADJUST IMAGE (for still pictures)	P. 84
MOVIE PLAY (for movies)	P. 67
EDIT IMAGE (for still pictures)	P. 78
EDIT (for movies)	P. 85
ALBUM	P. 69
CANCEL	P. 14
MODE MENU	P. 18
SLIDESHOW	P. 76
CALENDAR	P. 66
ERASE	P. 93

● Album playback mode

For still pictures

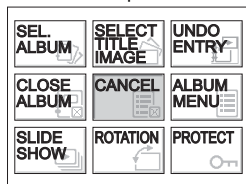

For movies

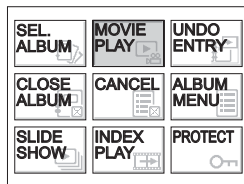

Menu items for taking pictures	Ref. Page
SEL. ALBUM	P. 72
SELECT TITLE IMAGE (for still pictures)	P. 73
MOVIE PLAY (for movies)	P. 67
UNDO ENTRY	P. 73
CLOSE ALBUM	P. 72
CANCEL	P. 14
ALBUM MENU	P. 69
SLIDESHOW	P. 76
ROTATION (for still pictures)	P. 66
INDEX PLAY (for movies)	P. 68
PROTECT	P. 91

Mode menu

● Shooting mode

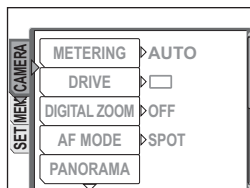

CAMERA tab	For setting shooting-related functions.
MEMORY/ CARD tab	For formatting internal memory or a card. Also saves internal memory data to a card.
SETUP tab	For setting basic camera functions and settings that make the camera easier to use.

● Playback mode

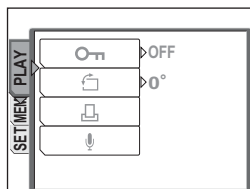

PLAY tab	For setting playback-related functions.
MEMORY/ CARD tab	For erasing all image data and formatting internal memory or a card. Also saves internal memory data to a card.
SETUP tab	For setting basic camera functions and settings that make the camera easier to use.

? TIPS

- The [MEMORY] tab is displayed when the internal memory is in use. The [CARD] tab is displayed when a card is inserted in the camera.
- For a list of mode menu items, see “Menu list” (P. 166).

Using the menus

Use the arrow pad and  to set menu items.

Follow the operation guide and arrows on the screen to select and change settings.

Ex: Setting [DRIVE]

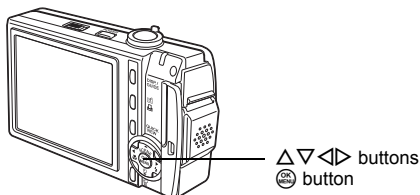

1 Set the mode switch to  to enable shooting mode.

2 Press .

- The top menu is displayed.

3 Press \triangleright to select [MODE MENU] and then press .

Top menu

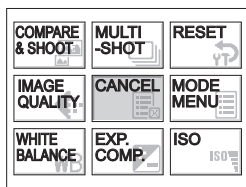

4 Press $\Delta \nabla$ to select the [CAMERA] tab, and press \triangleright .

- Refer to the arrows on the screen to select and make settings with the arrow pad.

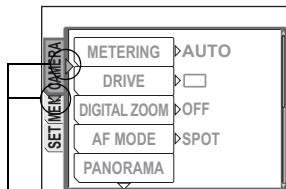

This refers to the arrow pad ($\triangleright \nabla$).

5 Press Δ / ∇ to select [DRIVE], and press \triangleright .

- Refer to the arrows on the screen to select and make settings with the arrow pad.
- Unavailable settings cannot be selected.

The selected item is displayed in a different color.

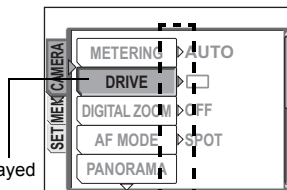

Press \triangleright to go on to the following setting.

6 Press Δ / ∇ to select from [\square], [img], or [MULTI-SHOT], and press OK (MENU).

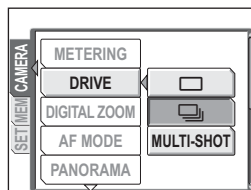

? TIPS

- The operation guide displayed at the bottom of the screen depends on the menu to be set. In this case, follow the operation guide to set or change settings using the arrow pad.

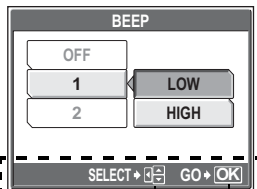

- Operation guide
- Press \triangleleft / Δ / ∇ to select a setting.
- Press OK (MENU) to finalize the setting.

Menu operation notation

In this manual, procedures for using the menus are expressed as follows:

- Ex: Steps 1 to 5 for setting [DRIVE]



Top menu \triangleright [MODE MENU] \triangleright [CAMERA] \triangleright [DRIVE]

Using the GUIDE function

This camera has a **GUIDE** function. Pressing the **DISP./GUIDE** button while a menu is displayed in shooting mode or playback mode automatically displays a menu guide explaining the menus.

1 When a menu is displayed, hold down the **DISP./GUIDE** button.

- The menu explanation is displayed.
- Release the **DISP./GUIDE** button to close the menu guide.

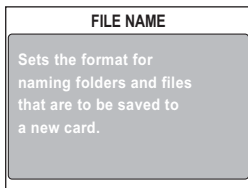

When [FILE NAME] is selected

How to read the procedure pages

1 Basic operation

A sample of a procedure page is shown below explaining the notation. Look at it carefully before taking or viewing pictures.

Indicates the position in which the mode switch is set. If multiple icons are displayed, the described function can be used in any of these modes. The icons of modes that cannot be used are shown in gray.

☞ “How to use the mode switch” (P. 9), “Mode switch notation” (P. 9)

Print settings (DPOF)

Single-frame reservation

How to make a single-frame reservation for a selected picture is shown below. Follow the operation guide to adjust settings.

For album playback mode, select the album that you want to make the print reservations for, and display the top menu.

Top menu > [MODE MENU] > [PLAY] > [A3] E3 “Using the menus” (P. 19)

For album playback mode: Top menu > [ALBUM MENU] > [A3]

Select [A3], and press [OK].

Operation guide

2 Follow the operation guide and press [OK] to select the frames and then of

Select the menus in the order indicated by >. ☞ “Using the menus” (P. 19), “Menu operation notation” (P. 20)

When procedures differ for different modes, the procedures are explained together.



Available languages may vary according to where you purchased the camera. The displayed language can be changed. ☞ “Selecting a display language” (P. 99)

This sample page is only for your reference. It may differ from the actual page in this manual.

Tips before you start taking pictures

2



Your pictures are almost guaranteed to come out well just by setting the mode switch to  or  and pressing the shutter button. But occasionally, you can't focus on your subject, the subject is too dark, or the picture doesn't come out the way you want.

Just knowing which button to press or which setting to change can help you solve these problems.

And did you know that by selecting an image size according to how you plan to use the pictures afterwards, you can store more pictures in the internal memory and on the memory card? These are just some of the hints provided in this chapter.

SH SUPER HIGH6M
for printing applications

? Ideas

B BASIC 1M for online applications

If the correct focus cannot be obtained

The camera automatically detects the focus target in the frame. The level of contrast is one of the criteria used to determine the subject. The camera may fail to determine subjects with lower contrast than the surroundings or with an area of extremely strong contrast in the frame. If this happens, the simplest solution is to use the focus lock.

How to focus (focus lock)



1 Position the AF target mark on the subject you want to focus on.

- When shooting a hard-to-focus or fast-moving subject, focus the camera on an object about the same distance away as the subject.



AF target mark

2 Press the shutter button halfway until the green lamp lights.

- The green lamp lights when the focus and exposure are locked.
- When the green lamp blinks, the focus and exposure are not locked. Release your finger from the shutter button, re-position the AF target mark on the subject and press the shutter button halfway again.

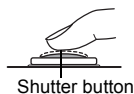

3 Keeping the shutter button pressed halfway, recompose your shot.

Green lamp



4 Press the shutter button fully.

- The camera takes the picture. The power/card access lamp blinks while the picture is recorded.



? TIPS

Focus on the subject in the center of the frame.

 "Changing the focusing area (AF MODE)" (P. 56)

! Note

- Press the shutter button gently. If it is pressed forcefully, the camera may move causing the picture to blur.
- Never open the battery compartment/card cover, remove the battery or disconnect the AC adapter while the power/card access lamp is blinking. Doing so could destroy stored pictures and prevent storage of pictures you have just taken.
- Recorded pictures are saved in the camera regardless of whether the camera is turned off or the battery is replaced or removed.
- When taking pictures against strong backlight, the area of the picture in shadow may appear colored.

Subjects that are difficult to focus on

Under certain types of conditions, the auto focus may not work properly.

The green lamp blinks.
The subject cannot be brought into focus.

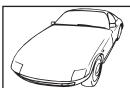

Subject with low contrast

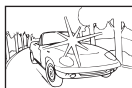

Subject with an extremely bright area in the center of the frame

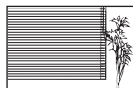

Subject without vertical lines

The green lamp lights, but the subject cannot be brought into focus.



Subjects at different distances

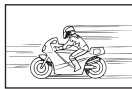

Fast-moving subject



The subject is not in the center of the frame

In these cases, focus (focus lock) on an object with high contrast at the same distance as the intended subject, recompose your shot and then take the picture. If the subject has no vertical lines, hold the camera vertically and focus the camera using the focus lock function by pressing the shutter button halfway, then return the camera to the horizontal position while keeping the button pressed halfway and take the picture.



You can select a record mode in which to take pictures or shoot movies. Select the best record mode for your purpose (printing, editing on a computer, website editing, etc.). For information on the image sizes for each record mode and the number of storable still pictures/movie recording time, see the tables on P. 27 and 28.

Still picture record modes

Still pictures are recorded in JPEG format.

Record mode depicts the image size of pictures.

Pictures are made from thousands of dots (pixels). If a picture with relatively few pixels is enlarged, it looks like a mosaic. Pictures with more pixels are denser and clearer but require more space (larger file size), thus decreasing the number of pictures that can be saved.

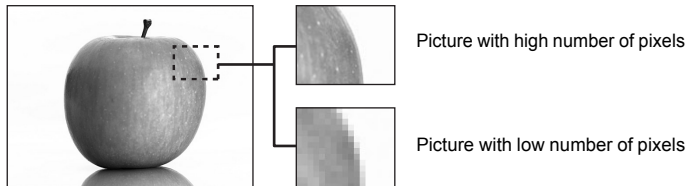

Record mode	Image size	Application
<input type="checkbox"/> SH SUPER HIGH6M	2816 × 2112	The number of storable still pictures is lower, and recording pictures takes longer, but it is useful for creating beautiful prints on full-size paper and for performing computer image processing, such as contrast adjustment and red-eye correction.
<input type="checkbox"/> H1 HIGH 4M	2288 × 1712	
<input type="checkbox"/> H2 HIGH 2M	1600 × 1200	This is useful for post-card sized prints, or for computer editing such as rotating or adding text to a picture.
<input type="checkbox"/> B BASIC 1M	1024 × 768	Standard image quality with a high number of pictures to shoot. This is useful for viewing pictures on a computer.
<input checked="" type="checkbox"/> E-MAIL VGA	640 × 480	This is useful for sending as e-mail attachments.

Image size

The number of pixels (horizontal × vertical) used when saving an image. You can save your pictures at a large image size to get clearer prints. However, as the image size increases, the file size (data size) also increases, which decreases the number of pictures that can be saved.

Movie record modes

Movies are recorded in Motion-JPEG format.

[FINE] and [STANDARD] offer an easy-to-see image size, but the recording time is short. [EXTENDED] offers longer recording time, but the picture may appear grainy.

Number of storable still pictures/remaining recording time**For still pictures**

Record mode	Image size	Number of storable still pictures			
		Internal memory		Using a 16 MB card	
		Without sound	With sound	Without sound	With sound
[SH] SUPER HIGH6M	2816 × 2112	6	6	10	10
[H1] HIGH 4M	2288 × 1712	9	9	15	15
[H2] HIGH 2M	1600 × 1200	15	14	24	23
[B] BASIC 1M	1024 × 768	36	33	58	52
[X] E-MAIL VGA	640 × 480	57	48	90	76

For movies

Record mode	Image size	Remaining recording time			
		Internal memory		Using a 16 MB card	
		Without sound	With sound	Without sound	With sound
F FINE	640 × 480 (30 frames/sec.)	5 sec.	5 sec.	8 sec.	8 sec.
S STANDARD	320 × 240 (30 frames/sec.)	15 sec.	14 sec.	24 sec.	23 sec.
E EXTENDED	160 × 120 (30 frames/sec.)	66 sec.	62 sec.	105 sec.	99 sec.



Number of storable still pictures



Remaining recording time

? TIPS

- When a picture is transferred to a computer, the size of the picture on the computer screen varies depending on the computer's monitor setting. For instance, a picture taken with an image size of 1,024 × 768 fills the screen if you set the picture to 1× when the monitor setting is 1,024 × 768. However, if the monitor setting is over 1,024 × 768 (such as 1,280 × 1,024), the picture only takes up part of the screen.

! Note

- The number of storable still pictures and remaining recording time listed in the tables are approximate.
- The number of storable still pictures may change according to the subject or factors like whether labels were added with the label shot function and if print reservations or album entries have been made or not. In certain instances, the number of remaining pictures does not change even when you take new pictures or erase stored pictures.

Changing the record mode



Top menu ▶ [IMAGE QUALITY]

☞ “Using the menus” (P. 19)

- 1** For still pictures, select from [SH SUPER HIGH6M], [H1 HIGH 4M], [H2 HIGH 2M], [B BASIC 1M] or [E-MAIL VGA].

For movies, select from [F FINE], [S STANDARD], and [E EXTENDED].

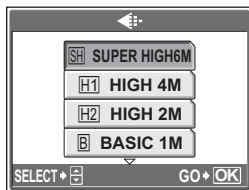

For still pictures

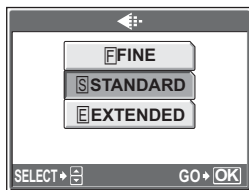

For movies

- 2** Press .

The internal memory and memory card

Pictures taken are recorded in the internal memory.

Pictures can also be recorded to an xD-Picture Card (“card”). The card can be used to record more pictures than is possible with the internal memory of the camera. A card can be convenient when taking many pictures while on a trip.

● Internal memory basics

The internal memory is the camera’s media for recording pictures, similar to film in a film camera.

Pictures recorded to the internal memory can be easily erased on the camera or processed using a computer. Unlike portable storage media, the internal memory cannot be removed or exchanged.

● Using the internal memory or card

You can confirm on the monitor whether the internal memory or card is being used during shooting and playback operations.

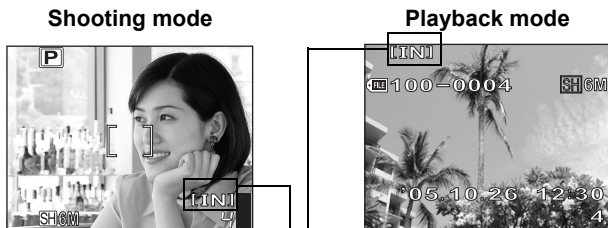

Monitor indication	Shooting mode	Playback mode
[IN]	Pictures are recorded to the internal memory.	Pictures are being played back from the internal memory.
[xD]	Pictures are recorded to a card.	Pictures are being played back from a card.

- The internal memory and a card cannot be used at the same time.
- The internal memory cannot be used for shooting or playback operations when a card is inserted in the camera. Remove the card before using the internal memory.
- Pictures recorded to the internal memory can be copied to a card.  “Copying pictures in the internal memory to the card (BACKUP)” (P. 92)

The card

The card is a medium for recording pictures, similar to film in a film camera. Pictures recorded to the card can be easily erased on the camera or processed using a computer. The number of recordable pictures can be increased by using a card with a larger capacity.

- ① **Index area**
You can use this space to write the contents of the card.
- ② **Contact area**
The part where the data transferred from the camera enters the card.

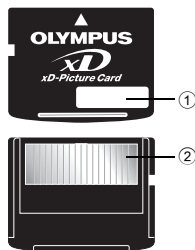

Compatible cards

xD-Picture Card (16 MB to 1GB)

Note

- This camera may not recognize a non-OLYMPUS card or a card that was formatted on another device (such as a computer, etc.). Make sure to format the card on this camera before use.  “Formatting the internal memory/card (MEMORY FORMAT/FORMAT)” (P. 96)

Inserting and removing the card

1 Make sure the camera is turned off.

- The monitor is off.
- The lens cover is closed.
- The power/card access lamp is off.

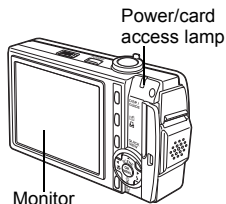

2 Open the battery compartment/card cover.

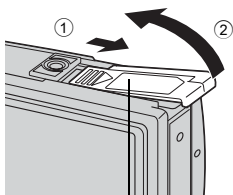

Battery compartment/card cover

● Inserting the card

3 Orient the card as shown, and insert it into the card slot as shown in the illustration.

- Insert the card straight in.
- Insert the card until it clicks into place.
- Inserting the card in the wrong direction or at an angle may damage the contacts and prevent the card from being removed.
- The card may not record properly if it is not inserted all the way in.

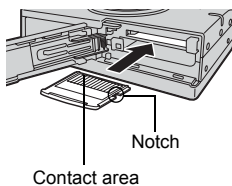

● Removing the card

3 Push the card all the way in and release slowly.

- The card protrudes slightly and stops.

Caution

Releasing your finger quickly after pushing the card all the way in may cause it to eject forcefully out of the slot.

- Grasp the card and remove.

4 Close the battery compartment/ card cover.

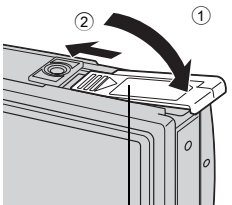
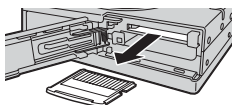
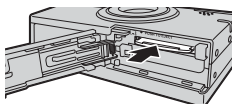

Battery compartment/ card cover

2

Tips before you start taking pictures

3

Basic shooting functions

A professional photographer adjusts the exposure to the optimal setting, chooses the best focusing method and even selects the type of film according to the subject. With a digital camera, you don't need to learn how to make difficult settings. Your camera will adjust the settings for you! All you have to do is choose a scene mode for whatever you want to take, whether a landscape, a night scene, or a portrait-style image, and the camera will set the best exposure and white balance. There's nothing to it – just press the shutter button!

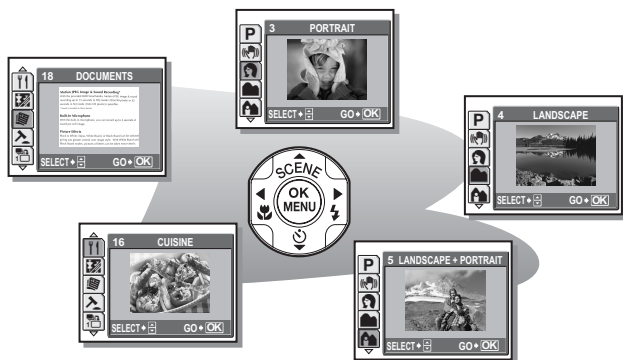

Selecting a scene according to the situation (SCENE)

When you select from the 26 types of **SCENE** according to the scene or conditions, the camera automatically selects the optimal settings.

● **SCENE mode**

P Program auto

Suitable for general situations. Simply press the shutter button, and the camera determines optimum conditions and shoots the picture. The camera automatically sets the optimum aperture value and shutter speed for the brightness of the subject (Program auto).

Reducing Blur*¹

This function reduces the blur incurred by a moving subject or camera movement when taking pictures.

Portrait

Suitable for taking portrait pictures. This mode accentuates the skin texture of the portrait subject.

Landscape

Suitable for taking pictures of landscapes and other outdoor scenes. Blues and greens are vividly reproduced.

Landscape + Portrait

Suitable for taking pictures of your subject against a distant background. Blues, greens, and skin tones are vividly reproduced.

Night Scene*²

Suitable for taking pictures in the evening or at night. The camera sets a slower shutter speed than is used in normal shooting.

Sports

Suitable for capturing fast-moving action. Even fast-moving subjects appear to be stationary.

Night + Portrait^{*2}

Suitable for taking pictures of your subject against a distant night scene. The camera sets a slower shutter speed than is used in normal shooting.

Indoor

Suitable for taking pictures of people indoors. The atmosphere of the background is also vividly reproduced.

Candle^{*2}

Suitable for capturing the atmosphere of a candle-lit scene. Warm colors are reproduced.
The flash cannot be used.

Self Portrait

Suitable for taking self-portrait pictures.

Available Light Portrait^{*2}

Suitable for shooting subjects in low light conditions without a flash.
The flash cannot be used.

Sunset^{*2}

Suitable for taking pictures of the evening sunlight. Reds and yellows are vividly reproduced.
The flash cannot be used.

Fireworks^{*2}

Suitable for taking pictures of fireworks displays. The camera sets a slower shutter speed than is used in normal shooting.
The flash cannot be used.

Museum

Suitable for taking pictures in museums and other places where flash photography is prohibited.
The flash cannot be used.

Cuisine

Suitable for taking pictures of food. Food colors are vibrantly reproduced.

Behind Glass

Suitable for shooting a subject through glass.
The flash cannot be used.

Documents

Suitable for taking pictures of documents or time schedules. The contrast between the text and background is enhanced.
The flash cannot be used.

Auction

Suitable for taking pictures of merchandise. The camera takes 3 pictures in succession at the best size while automatically adjusting the exposure.
The flash cannot be used.

Shoot & Select1 / Shoot & Select2

Pictures are taken in succession. You can erase unwanted pictures before saving the ones you want. Suitable for taking moving subjects.

Shoot & Select1  Focus is locked at the first frame.

Shoot & Select2  Takes pictures in succession, adjusting the focus 1 frame at a time.

Beach



Suitable for taking pictures on a sunny day at the beach. You can take pictures of your subject against a beautiful sky or landscape.

Snow

Suitable for taking pictures in the snow. You can take pictures of your subject against a beautiful sky or in the snow.

1 Under Water Wide1 / 2 Under Water Wide2

Suitable for taking pictures of scenery under water. Be sure to use the underwater housing.

Under Water Wide1 ( 1) Takes pictures, adjusting the focus 1 frame at a time. Position the AF target mark on the subject you want to focus on, and press ∇  to lock the focus position.

Under Water Wide2 ( 2) The focus is fixed at a distance of approximately 5.0 m (16.4 ft.). This distance may change depending on the water quality.

Under Water Macro

Suitable for taking pictures under water in macro mode. Be sure to use the underwater housing. Position the AF target mark on the subject you want to focus on, and press ∇  to lock the focus position.

*1 Pictures taken in a dark area may be grainy.

*2 Noise reduction is automatically enabled when the subject is dark. Processing time between shots is doubled and you cannot take pictures during this time.

TIPS

- If you select a scene that does not use the flash or a scene with a slower shutter speed, camera movement may occur. It is recommended that you use a tripod to prevent camera movement.
- In order to produce specialized effects, some scenes limit control of certain functions. For details, refer to "Functions available in shooting modes and scenes" (P. 177).



1 Press the \triangle SCENE button.

- The scene selection screen is displayed.

- 2** Press Δ / ∇ to select a scene, and press OK .

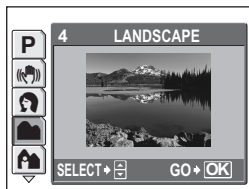
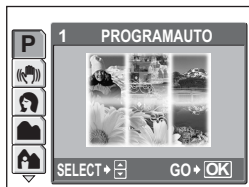

- 3** Take the picture.

- For shoot & select, hold down the shutter button.

● When [SHOOT & SELECT1] or [SHOOT & SELECT2] is selected

- After taking your pictures, the screen for selecting which pictures to erase is displayed.

The highlighted picture is enlarged.

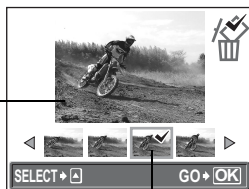

A \checkmark icon is displayed on the selected picture.

- ① Press \leftarrow / \rightarrow to select the picture you want to erase, and press Δ . Repeat Step ① to erase multiple pictures.
- ② When you have selected all the unwanted pictures, press OK .
- ③ Select [YES], and press OK .
 - The selected pictures are erased, and only the remaining pictures are saved.

! Note

- The number of shots that can be taken changes according to the record mode (for [SH] SUPER HIGH6M] approximately 3 shots).

Zooming in on your subject

Using the zoom

You can zoom in on your subject using the optical zoom and digital zoom. With the optical zoom, the image is enlarged on the CCD when the lens magnification is changed, and the image is formed by all the CCD pixels. With the digital zoom, the area at the center of the image captured by the CCD is cropped and enlarged. Because digital zoom takes a small area of the picture and enlarges it, the picture becomes grainy as the digital zoom magnification increases.

The following zoom magnifications are available on this camera.

Optical zoom	3× (equivalent to 38 mm to 114 mm on a 35 mm camera)
Optical zoom × digital zoom	Max. 18×

Note that camera movement is likely to occur at higher magnifications.



1 Turn the zoom lever.

Zoom lever

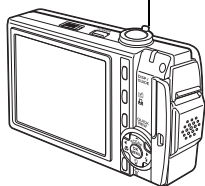

Zoom out:
Zoom lever turned to the W



Zoom in:
Zoom lever turned to the T

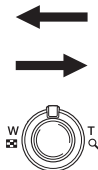

Using the digital zoom



Top menu ▶ [MODE MENU] ▶ [CAMERA] ▶ [DIGITAL ZOOM] ▶ [ON]
 ⓘ “Using the menus” (P. 19)

1 Turn the zoom lever to the T.

Optical zoom



The white area of the zoom indicator indicates the optical zoom. If the [DIGITAL ZOOM] is set to [ON], a red area is displayed on the zoom indicator. When you reach the limit of the optical zoom, the digital zoom is enabled.

Digital zoom



The cursor turns orange when inside the digital zoom area.



! Note

- Taking a picture with the digital zoom may cause the picture to appear grainy.

Using macro/super macro mode



Focusing is usually slow when you get close to a subject (W: 10 cm/3.9" to 30 cm/11.8", T: 50 cm/19.7" to 60 cm/23.6"). However, in macro mode focusing is performed quickly.

- This mode lets you shoot from as close as 10 cm/3.9 in. to your subject. (If optical zoom is set to maximum wide position)
- This mode lets you shoot from as close as 1 cm/0.4 in. to your subject. In this mode, normal shooting is also possible, but the magnification of the zoom is fixed automatically and cannot be changed.



1 Press repeatedly to set [] or [].

"Direct buttons" (P. 12)

- After 2 seconds of non-operation, the selection is set and the mode selection screen disappears.

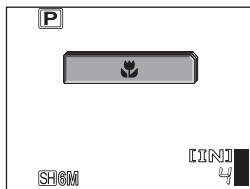

2 Take the picture.

Note

- During super macro mode, the zoom and flash are not available.
- When taking close-ups of a subject in super macro mode, use bright lighting to prevent the image from being too dark.



Select the flash mode best suited to the light conditions and the effect you want to achieve.

Flash working range

W (max.): Approx. 0.3 to 2.6 m (1.0 to 8.5 ft.)

T (max.): Approx. 0.5 to 2.1 m (1.6 to 6.9 ft.)

Auto-flash (No indication)

The flash fires automatically in low light or backlight conditions.

Red-eye reduction flash (👁)

The light from the flash may make the subject's eyes appear red in the picture. The red-eye reduction flash mode reduces this phenomenon by emitting pre-flashes before firing the regular flash.



The subject's eyes appear red.

! Note

- After the pre-flashes, it takes about 1 second before the shutter is released. Hold the camera firmly to avoid camera movement.
- Effectiveness may be limited if the subject is not looking directly at the pre-flashes, or if the shooting range is too far. Individual physical characteristics may also limit effectiveness.

Fill-in flash (⚡)

The flash fires regardless of the available light. This mode is useful for eliminating shadows on the subject's face (such as shadows from tree leaves), in a backlight situation, or for correcting the color shift produced by artificial lighting (especially fluorescent light).



! Note

- The fill-in flash may not have the desired effect under excessively bright light.

Red-eye fill-in (👁⚡)

The flash always fires after pre-flashes for red-eye reduction are emitted.

Flash off (🚫)

The flash does not fire even in low light conditions. Use this mode in situations where flash photography is not desired or is prohibited. You can also use this mode when shooting landscapes, sunsets, and other subjects outside the range of the flash.

! Note

- Since a slow shutter speed is automatically selected in low light situations when in the flash off mode, the use of a tripod is recommended to prevent your pictures from being blurred by camera movement.



1 Press **▶⚡** repeatedly to set the flash mode.

- “Direct buttons” (P. 12)
- After 2 seconds of non-operation, the selection is set and the mode selection screen disappears.
- Each time you press **▶⚡**, the flash mode changes in the following order.

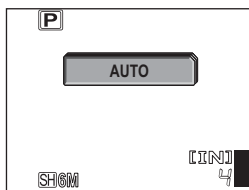
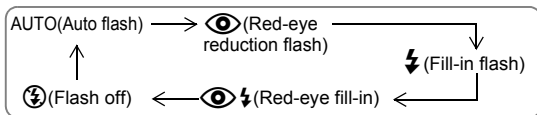

2 Press the shutter button halfway.

- In conditions where the flash will fire, the **⚡** mark lights (flash stand-by).

3 Press the shutter button fully to take the picture.

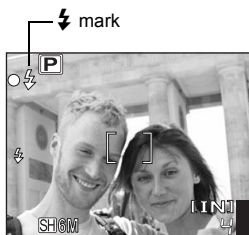

? TIPS

The ⚡ mark blinks.

→ Flash charging. Wait until the ⚡ mark turns off.

→ [Ⓢ] is set. Change the setting to something other than [Ⓢ] or use a tripod.

! Note

- The flash does not fire in the following situations:
Super macro mode, multi-shot, panorama and label shot.
- The flash may not give you the optimum result in macro mode with the zoom set to wide-angle (W). Check the resulting picture on the monitor.

Self-timer shooting



This function lets you take pictures using the self-timer. Fix the camera securely on a tripod for self-timer shooting. This function is useful for taking pictures when you want to be included in the photograph.



1 Press ∇ and \odot and set to [Ⓢ ON].

☞ “Direct buttons” (P. 12)

- After 2 seconds of non-operation, the selection is set and the mode selection screen disappears.

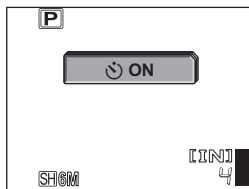

2 Press the shutter button fully to take the picture.

- Pressing the shutter button halfway locks the focus and exposure.
- The self-timer lamp lights for approximately 10 seconds, then starts blinking. After blinking for approximately 2 seconds, the picture is taken.
- To stop shooting while in \odot mode, press the shutter button fully again.
- To cancel the self-timer, press ∇ and \odot .
- The self-timer mode is automatically canceled after one shot.

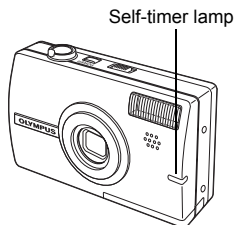



This function allows you to record movies.

When the record mode is set to [F FINE], the camera can record up to 20 seconds.



1 Compose your picture.

- You can use the zoom lever to enlarge your subject.



Remaining recording time

2 Press the shutter button fully to start recording.

- The power/card access lamp blinks while the movie is being saved.
- During movie recording, the [S] mark lights red.



3 Press the shutter button again to stop recording.

- When the remaining recording time has been used up, recording stops automatically.
- When there is space in the internal memory or the card, the remaining recording time (P. 28) is displayed, and the camera is ready to shoot.

? TIPS

To record audio with the movie



→ Set [M] to [ON]. "Recording sound with movies" (P. 48)

To use the zoom during movie recording

→ If you set [Z] to [OFF], you can use the optical zoom during movie recording. "Recording sound with movies" (P. 48)

→ Set [DIGITAL ZOOM] to [ON]. "Using the digital zoom" (P. 41)

! Note

- The remaining recording time may drop rapidly during recording. Try using the internal memory or card again after formatting it with your camera.
 "Formatting the internal memory/card (MEMORY FORMAT/FORMAT)" (P. 96)
- In  mode, the flash is not available.

Camera movement compensation (IMAGE STABILIZER)



This function reduces the blur incurred by camera movement when taking movies. The area in which the picture is captured by the CCD is adjusted according to movement of the subject, thereby enabling recording of the picture with reduced blurring of the subject. The images are recorded slightly larger when [IMAGE STABILIZER] is set to [ON].



Top menu ▶ [IMAGE STABILIZER] ▶ [ON]  "Using the menus" (P. 19)

1 Take the picture.

Displayed during camera movement compensation.



! Note

- When the camera moves a lot or the subject is moving quickly, the compensation function may not operate effectively.
- When taking pictures with the camera stabilized, set [IMAGE STABILIZER] to [OFF], otherwise the movement of the subject may cause the image on the screen to move.

Fulltime AF

When [FULLTIME AF] is set to [ON], the subject is automatically kept in focus during movie recording.



Top menu ▶ [MODE MENU] ▶ [CAMERA] ▶ [FULLTIME AF] ▶ [ON]/[OFF]
 “Using the menus” (P. 19)

! Note

- Setting [FULLTIME AF] to [ON] consumes more battery power.
- [FULLTIME AF] cannot be used when [i] is set to [ON].

Recording sound with movies



Sound can be recorded while shooting a movie.



Top menu ▶ [MODE MENU] ▶ [CAMERA] ▶ [i] ▶ [ON]
 “Using the menus” (P. 19)

! Note

- If the camera is more than 1 m (3.3 ft.) away from the source of the sound, sound may not be recorded clearly by the built-in microphone.

Additional shooting functions



4

Taking pictures like a pro...

Adjust the brightness or white balance of the picture, change the focusing area depending on the subject, and make use of other useful functions to create professional-like pictures.

At night or in the evening...

Adjust the colors of the night sky. Set the white balance to [☾] to give a bluish tinge to a dark sky.

In the outdoors or at scenic sites...

Use panorama mode to capture a beautiful mountain range or impressive building.



Shoot pictures while checking the shot you just took (COMPARE & SHOOT)



When COMPARE & SHOOT is set to [ON], the four previous frames are displayed on the left side. You can compare the previous pictures when you take the next picture.

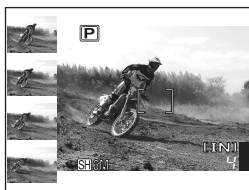

As you take pictures, the picture you took appears at the upper left, and the four frames on the left move down one with the bottom leaving the display.

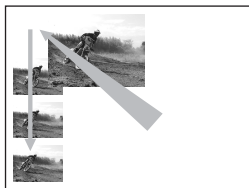

Top menu ▶ [COMPARE & SHOOT]

☞ "Using the menus" (P. 19)

- 1 Select [ON] or [OFF], and press .

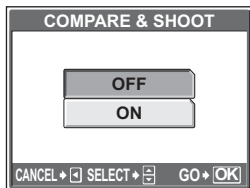

? TIPS

- You can select the picture displayed on the left. The picture on the upper left becomes the picture selected in playback mode when a picture is selected once in playback mode and the camera is changed to shooting mode. When this happens, new images that are shot are moved to the upper left position but the four on the left side do not change.

Changing ISO sensitivity (ISO)

ISO

The higher the ISO, the better the camera's light sensitivity and ability to shoot in low light conditions. However, high sensitivity introduces noise into the resulting picture, which may give it a grainy appearance.

AUTO

Sensitivity is automatically adjusted according to the conditions of the subject.

64/100/200/400

With a low ISO setting, you can shoot clear, sharp images in daylight. With a high ISO setting, you can shoot in dark places.



Top menu ▶ [ISO]

☞ “Using the menus” (P. 19)

1

Select the ISO from [AUTO], [64], [100], [200], and [400], and then press .

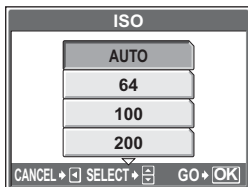

Note

- ISO is based on the sensitivity of normal camera film.

4

Additional shooting functions

Changing picture brightness (EXP. COMP.)



In some situations, you may get better results when the exposure that the camera sets is compensated (adjusted) manually. You can adjust the exposure in the range of ± 2.0 EV in $1/3$ EV steps. When the exposure is changed, you can check the result on the monitor.



4

Additional shooting functions

Top menu ▶ [EXP. COMP.]

☞ “Using the menus” (P. 19)

1 Press Δ / ∇ to adjust the exposure, and press **OK** OK MENU.

- Adjust toward [+] to brighten the image or [-] to darken the image.

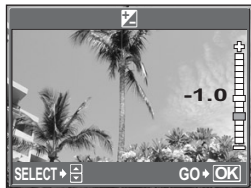

2 Take the picture.

? TIPS

- Often, bright subjects (such as snow) turn out darker than their natural colors. Adjust toward [+] to make these subjects closer to their real shades. To prevent the picture from getting brighter, adjust toward [-] when shooting dark subjects.

! Note

- Sometimes, using the flash may not produce the brightness (exposure) that was intended.
- The effects of exposure compensation may be limited when the surroundings of the subject are extremely bright or dark.

Adjusting the color of a picture (WHITE BALANCE)

WB

The color of the subject differs depending on lighting conditions. For instance, when daylight, the setting sun or tungsten lighting are reflected on white paper, the shade of white produced will be slightly different for each. By adjusting the white balance, you can achieve more natural-looking colors.

AUTO The white balance is adjusted automatically for natural color, regardless of the light source.



For natural colors under a clear sky.



For natural colors under a cloudy sky.



For natural colors under tungsten lighting.



For natural colors under fluorescent lighting.



Top menu ▶ [WHITE BALANCE]

☞ “Using the menus” (P. 19)

- 1 Select a white balance setting, and press .

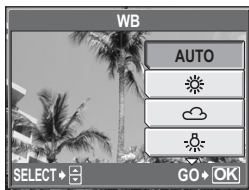

? TIPS

- You can select a white balance setting other than the actual light source, and enjoy the different color tones on the monitor.

! Note

- White balance may not be effective under some special light sources.
- When taking pictures with the white balance on a setting other than [AUTO], play back the picture and check the colors on the monitor.
- When the flash is fired with a white balance setting other than [AUTO], colors may appear different in the resulting picture from the colors you see on the monitor.

Changing the area for measuring the brightness of a subject (METERING)

When taking pictures against backlight, the face of the subject may appear darker. With spot metering, the picture can be taken based on the brightness at the center of the monitor without being affected by the light in the background.

AUTO Meters the brightness at the center of the monitor and the surrounding area separately to create a picture with balanced brightness. When taking pictures against strong backlight, the center of the picture may appear dark.

 Only the center of the monitor is metered. Suitable for taking a picture of the subject in the center of the monitor against backlight.



4

Additional shooting functions

Top menu ▶ [MODE MENU] ▶ [CAMERA] ▶ [METERING]

 "Using the menus" (P. 19)

1 Select [AUTO] or , and press

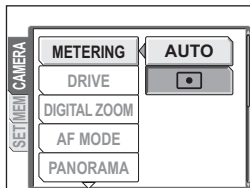

Sequential shooting ([] / MULTI-SHOT)



You can take a sequence of pictures at one time while holding down the shutter button.

- Shoots 1 frame at a time when the shutter button is pressed. Focus, exposure and white balance are locked at the first frame. The sequential shooting speed varies depending on the record mode setting.
- MULTI-SHOT** Pictures are taken at a faster speed than normal sequential shooting. Nine pictures are automatically saved as one image when the shutter button is held down continuously (for a maximum of 5 seconds).



Top menu ▶ [MODE MENU] ▶ [CAMERA] ▶ [DRIVE] ▶ [] / [MULTI-SHOT]
☞ “Using the menus” (P. 19)

1 Take the picture.

- Press the shutter button fully and keep it pressed. The camera will take pictures in sequence until you release the button.
- MULTI-SHOT can also be selected by selecting [MULTI-SHOT] then [ON] from the top menu and then pressing .

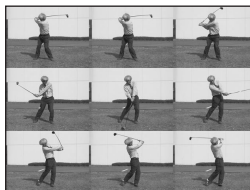

MULTI-SHOT image

! Note

- The number of shots that can be taken changes according to the sequential shooting mode (for [SH] SUPER HIGH6M) approximately 3 shots).
- During MULTI-SHOT, the flash is not available.
- During panorama shooting, sequential shooting and MULTI-SHOT are not available.
- If the battery power is low and blinks during shooting, shooting stops and the camera starts saving the pictures you have taken. Whether or not all of the shots are saved depends on how much battery power remains.
- There are some limitations on the scene mode functions when multi-shot is set from the scene modes.

Changing the focusing area (AF MODE)

This function allows you to select how the camera focuses on your subject.

AUTO The camera determines which subject within the screen to focus on. Even when the subject is not in the center of the screen, focusing is possible.

SPOT Focus selection is based on the subject within the AF target mark.



Subject suitable for [AUTO]

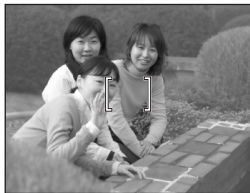

Subject suitable for [SPOT]

4

Additional shooting functions



Top menu ▶ [MODE MENU] ▶ [CAMERA] ▶ [AF MODE]

▶ Using the menu" (P. 19)

1 Select [AUTO] or [SPOT], and press .

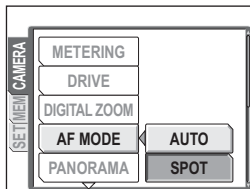

Panorama shooting

You can take advantage of panorama shooting with an Olympus xD-Picture Card. Panorama shooting lets you connect pictures with overlapping edges into a single panoramic picture, using the OLYMPUS Master software.

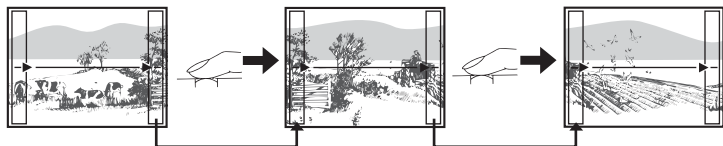

The part of the previous picture where it will be joined to the next picture does not remain in the frame on the edge of the screen. You have to remember what the part in the frame looked like and take the next picture so it overlaps. Compose your shots so that the right edge of the previous picture overlaps the left edge of the next picture if you are connecting pictures from left to right (or vice versa if you are connecting pictures from right to left).



Top menu ▶ [MODE MENU] ▶ [CAMERA] ▶ [PANORAMA]

"Using the menus" (P. 19)

1 Use the arrow pad to choose at which edge you want to connect the pictures.

- ▷ : The next picture is connected at the right edge.
- ◁ : The next picture is connected at the left edge.
- △ : The next picture is connected at the top.
- ▽ : The next picture is connected at the bottom.

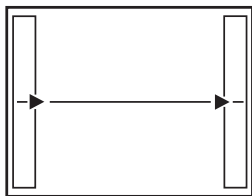

Connects pictures from left to right

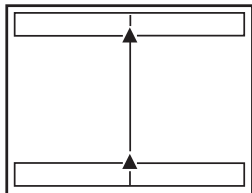

Connects pictures from bottom to top

2 Make sure that the edges of the pictures overlap, then take the pictures.

- The focus, exposure and white balance are set by the first picture. Do not select an extremely bright subject (such as the sun) for the first picture.
- You cannot adjust the zoom after the first picture.
- Panorama shooting is possible for up to 10 pictures.
- When you have taken 10 pictures, a warning mark  is displayed.



3 Press to exit panorama shooting.

Note

- Panorama mode is not available when there is no card in the camera. Panorama mode is only available with Olympus cards.
- During panorama shooting, the flash, sequential shooting and multi-shot are not available.
- The camera itself cannot connect panorama pictures. The OLYMPUS Master software is necessary to connect the pictures.

Creating labels for combined LABEL (LABEL SHOT)

You can make the labels you like for combined LABEL (👁️ P. 81). Shoot the picture and text for the label and save them as a combined label shot file.



Top menu ▶ [MODE MENU] ▶ [CAMERA] ▶ [LABEL SHOT]

👁️ “Using the menus” (P. 19)

1 Decide on the layout for the picture and text for the label.

- The design of the label to be created is displayed in red.

2 Press Δ / ∇ to adjust the range of the red display.

3 Take the picture.

- You can take a maximum of 100 shots.
- You can adjust the range of the red display for shooting.

4 Press OK after taking a picture.

5 Press \leftarrow / \rightarrow to move the cursor to the picture you want to erase, and press Δ to select it.

- A ✓ icon is displayed on the selected picture.
- Repeat Step 5 to erase multiple pictures.

6 When you have selected all the unwanted pictures, press OK .

7 Select [YES], and press OK .

- The selected pictures are deleted and the remaining pictures are saved as a combined label shot.
- The design of the label that is saved is black and white. You can change the color when combining labels shots.

! Note

- A warning icon (🚫) is displayed if you cannot shoot pictures because the internal memory or card is full or some other reason.

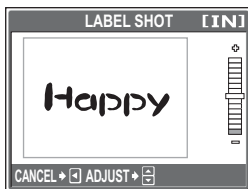

Recording sound with still pictures



Sound can be recorded when taking still pictures. Recording starts about 0.5 seconds after the shutter is released and lasts about 4 seconds. When this function is enabled, sound is recorded automatically every time you take a picture.



Top menu ▶ [MODE MENU] ▶ [CAMERA] ▶ [🎤] ▶ [ON]

"Using the menus" (P. 19)

1 Take the picture.

- When recording starts, aim the camera microphone at the source of the sound you want to record.

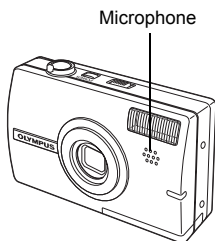

? TIPS

- [J] is displayed when still pictures with sound are played back. During playback, sound is omitted from the speaker. The volume can be adjusted.
- Sound can be added later to still pictures. Recorded sound can also be re-recorded. "Adding sound to still pictures" (P. 77)

! Note

- If the microphone is farther than 1 m (3.3 ft.) from the subject, sound may not be recorded properly.
- Pictures cannot be taken during sound recording.
- Recording sound with still pictures cannot be done in the following situations.
Sequential shooting, multi-shot, panorama and label shot.
- Sound recording may also pick up camera noises, such as button operations, shutter movement, etc.
- Sound recording may not be possible if there is insufficient space in the internal memory or the card.

Changing the monitor display (DISP./GUIDE)

This function displays histograms and lines that help you to compose your pictures.



1 Press the DISP./GUIDE button repeatedly.

- Press the **DISP./GUIDE** button to change the display in the following order.
☞ “Direct buttons” (P. 12)

Displays only basic information.



Displays only the AF target mark.

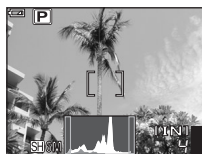

Displays a histogram showing the luminance distribution of the picture.
The histogram display changes depending on the [] setting.
This screen is not displayed if [] is [OFF].
This screen is not displayed in [] mode.

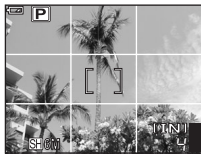

Displays lines. The lines displayed will change depending on the [FRAME ASSIST] setting.
This screen is not displayed if [FRAME ASSIST] is [OFF].
This screen is not displayed in [] mode.

? TIPS

- Information is displayed on the monitor when the display is changed or menu operations are performed. For details about displayed information, refer to “Monitor Symbols & Icons” in the “Basic Manual”.

Histogram



This displays the histogram. You can take pictures while checking the distribution of brightness of the subject, thereby enabling you to closely check the exposure.

- OFF** The histogram is not displayed.
- ON** The histogram is displayed as a graph.
- DIRECT** Displays the overexposed and underexposed areas directly on the picture.
When [DIRECT] is enabled, the histogram in playback mode is also displayed directly on the picture.



Top menu ▶ [MODE MENU] ▶ [SETUP] ▶ ▶ [OFF]/[ON]/[DIRECT]
 “Using the menus” (P. 19)

? TIPS

How to read the histogram

- ① If the peak fills too much of the left frame, the image will appear mostly black.
- ② If the peak fills too much of the right frame, the image will appear mostly white.
- ③ The part indicated in green in the histogram shows the luminance distribution within the AF target mark.

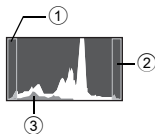

Display for [DIRECT] settings





Red dots: The overexposed areas
Blue dots: The underexposed areas

! Note

- The histogram displayed during shooting may differ from the histogram displayed during playback.

Frame assist

This displays the frame assist and determines the type of frame assist. Refer to this when composing your picture.

- OFF** Frame assist is not displayed.
-  Displays horizontal and vertical lines.
-  Displays diagonal lines.



Top menu ▶ [MODE MENU] ▶ [SETUP] ▶ [FRAME ASSIST] ▶
 [OFF]//  "Using the menu" (P. 19)

5

Playback

With film-type cameras, you cannot see the pictures you have taken until the film has been developed. Aren't you sometimes disappointed with the results when you do eventually see them? Pictures of blurred scenery or someone with their eyes shut. Or maybe you took several pictures of the same scene because you weren't sure whether they would come out or not. That's no way to record important memories!

With a digital camera, you can review your pictures immediately. Just play the picture back as soon as you've taken it. If you don't like what you see, erase and take it again. So don't be afraid of pictures not coming out well; just keep on pressing that shutter button!

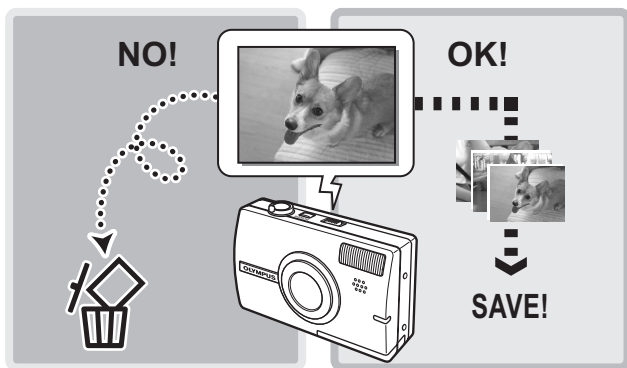

Playing back still pictures



The pictures on a card are played back if a card is inserted in the camera. Remove the card to play back pictures stored in the internal memory.



- The last picture taken is displayed on the monitor (single-frame playback).
- Pressing the **QUICK VIEW** button in shooting mode also enables playback.
- Use the arrow pad to browse the pictures.

1 Turn the zoom lever to the **T** or **W**.

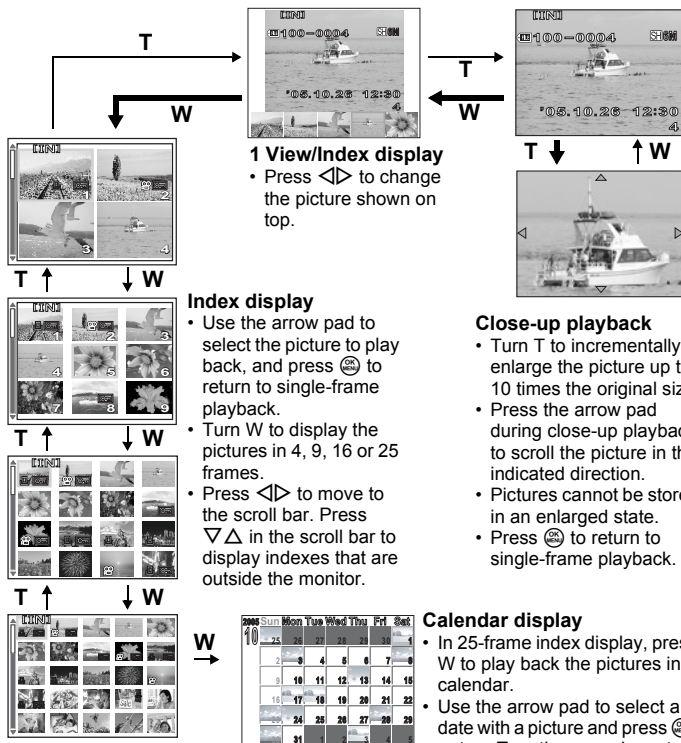

Playing back pictures in a calendar (CALENDAR)

This function allows you to display the pictures you have taken in a calendar format. When a still picture or movie is recorded, it is automatically registered to the calendar by the date of recording.

You need to have the date and time set on the camera before shooting if you want your pictures to be played back on the correct date with the calendar display.

 “Setting the date and time” (P. 107)



Top menu ▶ [CALENDAR]

 “Using the menus” (P. 19)

- A monthly calendar is displayed. Select the date to play back and press  to play a single frame.

Picture rotation (ROTATION)

Pictures taken with the camera held vertically are displayed horizontally. This function lets you turn such pictures 90° clockwise or counterclockwise so that they are displayed vertically.

Select the picture that you want to rotate and display the top menu.



Top menu ▶ [MODE MENU] ▶ [PLAY] ▶  ▶ [+90°]/[0°]/[-90°]

 “Using the menus” (P. 19)

- For album playback mode: **Top menu** ▶ [ROTATION] ▶ [+90°]/[0°]/[-90°]

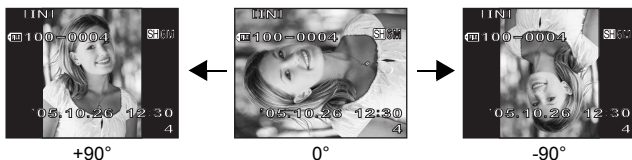

Note

- The following pictures cannot be rotated.
Movies, protected pictures, computer-edited pictures, and pictures taken with another camera
- New picture orientations are saved even when the power is turned off.

Playing back movies



This function lets you play back movies. You can fast forward the movie or play it back one frame at a time. Select the movie that you want to play, then display the top menu.



Top menu ▶ [MOVIE PLAY]

☞ “Using the menus” (P. 19)

- The movie is played back. When playback ends, the camera automatically returns to the beginning of the movie.

● Operations during movie playback

Change the volume or speed during playback.

- △ : Increases the volume.
- ▽ : Reduces the volume.
- ▷ : Each time you press the button, the playback speed changes in the following order: 2×; 20×; and back to 1×.
- ◁ : Plays the movie in reverse. Each time you press the button, the playback speed changes in the following order: 2×; 20×; and back to 1×.
- ⊞ : Pauses the movie.



● Operations during pause

You can play back the movie frame by frame.

- △ : Displays the first frame.
- ▽ : Displays the last frame.
- ▷ : Displays the next frame.
- ◁ : Displays the previous frame.
- ⊞ : The [MOVIE PLAY] screen is displayed.



Playing time/Total recording time

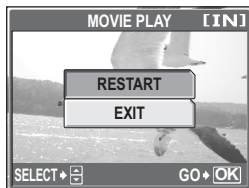

[MOVIE PLAY] screen

! Note

- The power/card access lamp blinks while the camera is reading the movie. Reading of movies may take some time. Do not open the battery compartment/ card cover while the power/card access lamp is blinking. Doing so may damage the data in the internal memory or the card and render the internal memory or card unusable.

Selecting the position to begin movie playback (INDEX PLAY)



This function displays a movie with a time index, allowing you to play back the movie from the desired frame.



Top menu ▶ [INDEX PLAY]

“Using the menus” (P. 19)

1 Press Δ ∇ \triangleleft \triangleright to select a frame.

- Turn the zoom lever to change the number of displayed index frames.

2 Press .

- Movie playback begins from the selected frame.

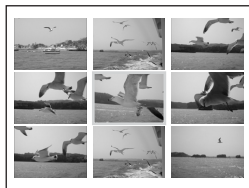



Pictures recorded to the card can be organized by sorting them into albums. Pictures stored in the internal memory cannot be entered in albums. You can enter up to 100 pictures into each of the available 12 albums. Using the provided OLYMPUS Master software, you can enter pictures from a computer into an album on a card.

● Album playback mode menu

Select [ALBUM] and then [SEL. ALBUM] in the top menu of the playback mode, to change to album playback mode. Press in album playback mode to display the album playback mode top menu. Adjust settings in the album playback mode menu using the arrow pad and , like the shooting mode and playback mode. "Menus" (P. 14)

Top menu

For still pictures

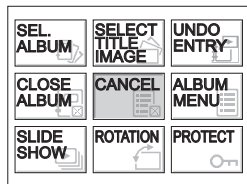

For movies

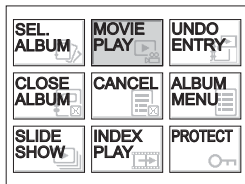

Album menu

Select [ALBUM MENU] in the top menu of the album playback mode to display the [ALBUM MENU] screen.

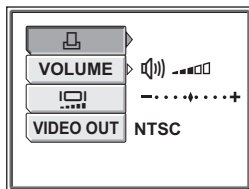

Functions that can be set in [ALBUM MENU]

Function	Ref. Page	Function	Ref. Page
	P. 125		P. 107
VOLUME	P. 103	VIDEO OUT	P. 90

Adding pictures to an album (ALBUM ENTRY)

You can enter pictures or movies in an album.



Top menu ▶ [ALBUM] ▶ [ALBUM ENTRY] "Using the menus" (P. 19)

1 Select the album entry method.

- SEL. IMAGE** Selects one frame at a time for entry.
- SET CALENDAR** Selects a date on the calendar display, and enters one picture from that date into the album.
- SET ALL** Selects all still pictures, or all movies, or all protected pictures, and enters them into one album.

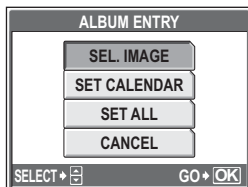

2 Press to select an album, and press .

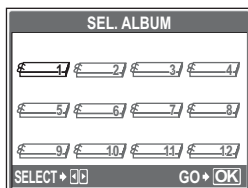

● SEL. IMAGE

3 Press to select a picture to enter in the album, and press .

- A ✓ icon is displayed on the selected picture.
- Press again to cancel the selection.
- Repeat Step 3 to enter multiple pictures.
- Turn the zoom lever to the T to display a picture using single-frame playback.



4 After selecting all the pictures to enter, hold down .

5 Select [YES], and press .

● SET CALENDAR

3 Press $\Delta \nabla \leftarrow \rightarrow$ to select the date with pictures to enter in the album, and press OK MENU.

4 Select [YES], and press OK MENU.

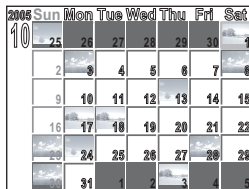

● SET ALL

3 Select [PHOTO], [MOVIE] or [O-TT], and press OK MENU.

4 Select [YES], and press OK MENU.

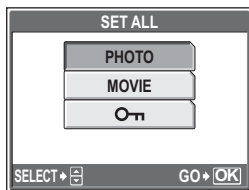

! Note

- The same picture cannot be entered in multiple albums.

Viewing pictures in albums



Top menu ▶ [ALBUM] ▶ [SEL. ALBUM]

☞ “Using the menus” (P. 19)

1 Press ◀▶ to select an album to view, and press .

- The title image for each album is displayed.



2 Use ▲▼◀▶ to display the picture you want.

- ▶ : Displays the next picture.
- ◀ : Displays the previous picture.
- ▲ : Jumps to the picture 10 frames back.
- ▼ : Jumps to the picture 10 frames ahead.

- When playing back still pictures, turn the zoom lever to the T for close-up playback. During close-up playback, use the arrow pad to scroll.

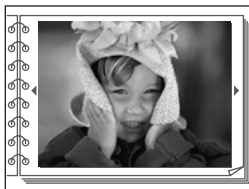

3 To exit album display, press to display the top menu, and select [CLOSE ALBUM].

? TIPS

- To display pictures from other albums, select [SEL. ALBUM] from the top menu in album playback mode, and select the album you want to change.

Selecting an album cover (SELECT TITLE IMAGE)



You can change the title image (first frame in album) displayed on the [SEL. ALBUM] screen.

Select the album to change and display the still image and then display the album playback top menu.

Top menu ▶ [SELECT TITLE IMAGE]

☞ “Using the menus” (P. 19)

1 Press ◀▶ to select the picture for the title image, and press .

2 Select [OK], and press .

- The title image for the album is changed.

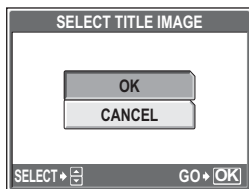

Undoing album entries (UNDO ENTRY)



You can cancel pictures entered in an album. The picture will still be saved on the card. This only removes the picture from the album.

Select the album containing the image to reset, then display the album playback top menu.

Top menu ▶ [UNDO ENTRY]

☞ “Using the menus” (P. 19)

1 Select the album undo method, and press .

- SEL. IMAGE** Selects one frame at a time to undo.
- UNDO ALL** This will undo all images in the album.

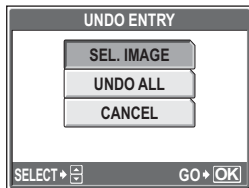

● SEL. IMAGE

2 Press $\Delta \nabla \triangleleft \triangleright$ to select the pictures to undo, and press OK .

- A \checkmark icon is displayed on the selected picture.
- Press OK  again to cancel the selection.
- Repeat Step 2 to undo multiple pictures.
- Turn the zoom lever to the T to display a picture using single-frame playback.



3 After selecting all the pictures to undo, hold down OK .

4 Select [YES], and press OK .

● UNDO ALL

2 Select [YES], and press OK .

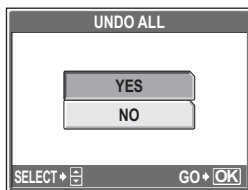

Erasing pictures from albums



You can erase pictures entered in an album. Unlike undoing album pictures, this erases the picture from the card.

Display and erase a picture from an album.

Note

- You cannot erase protected pictures. Cancel protection before erasing such pictures. “Protecting pictures (PROTECT)” (P. 91)
- Once erased, pictures cannot be restored. To only remove pictures from the album, use [UNDO ENTRY]. “Undoing album entries (UNDO ENTRY)” (P. 73)



1 Select the picture you want to erase, and press the button.

“Direct buttons” (P. 12)

2 Select [YES], and press .

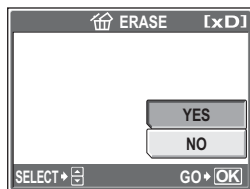



This function displays pictures stored in the internal memory or the card one after another. You can select from 12 different transition effects. Only the first frame of each movie is displayed.

● Types of slide shows

- SCROLL
- FADER
- ZOOM
- CHECKERBOARD
- BLINDS
- SWIVEL
- POP
- HEARTS
- CIRCLE
- SQUARE 1
- SQUARE 2
- RANDOM



Top menu ▶ [SLIDESHOW]

"Using the menus" (P. 19)

1 Select a transition effect for the slideshow, and press

- The slideshow starts.
- The slideshow will not stop until you cancel it by pressing .

Note

- It is recommended to use the AC adapter when running a slideshow for a long period of time. The camera will enter sleep mode after running on the battery for 30 minutes and stop the slideshow automatically.

Adding sound to still pictures



Sound can be added to a still picture that you have already taken. You can also re-record over the sound that has already been recorded. Total recording time per picture is approximately 4 seconds.

Select the still picture to which you want to add sound and display the top menu.



Top menu ▶ [MODE MENU] ▶ [PLAY] ▶ [U] “Using the menus” (P. 19)

1 Press to display [START].

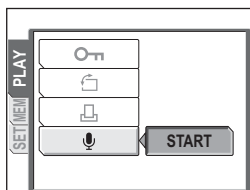

2 Aim the camera microphone toward the sound you want to record, and press to start recording.

- The [BUSY] bar is displayed during recording.

Microphone

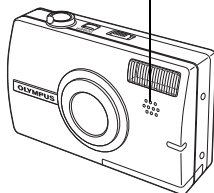



Note

- If the microphone is farther than 1 m (3.3 ft.) from the subject, sound may not be recorded properly.
- If you re-record the sound, the original sound is erased.
- Sound recording is not possible if there is insufficient space in the internal memory or on the card.
- The microphone may pick up the sound of buttons operated.
- Once sound is added to a picture, it is not possible to erase the sound. In this case, make a re-recording with silence.

Editing still pictures ([REDEYE FIX]/[BLACK & WHITE]/[SEPIA])



This function lets you edit still pictures and store them as new pictures. The following editing operations are possible.

-  Changes the image size to 640 × 480 or 320 × 240 and saves the picture as a new file.
-  Save one part of an image as another image.
- REDEYE FIX** Corrects the red-eye phenomenon caused by the flash making the subject's eyes appear red in the picture, and saves the picture as a new file.
- BLACK & WHITE** Changes the picture to black and white and saves it as a new file.
- SEPIA** Changes the picture to sepia and saves it as a new file.

Select the picture that you want to edit and display the top menu.





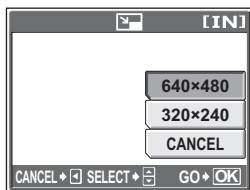

Top menu ▶ [EDIT IMAGE] ▶ [REDEYE FIX]/[BLACK & WHITE]/[SEPIA]  "Using the menus" (P. 19)

1 ● When [REDEYE FIX] is selected

Select [640 × 480] or [320 × 240], and press .





● When [] is selected

- ① Select [NEW FILE], and press .
- ② Adjust the trimming position and size.
 -  Adjusts the trimming position of the picture.
 - Zoom lever Adjusts the size of the picture.
- ③ Press .
- ④ Select [OK], and press .



● When [REDEYE FIX] is selected

- ① Select [NEW FILE], and press .
 - After the [BUSY] bar is displayed, the areas targeted for correction are framed in blue.
- ② Press .
 - When the blue frame is not displayed, red-eye correction is not available.

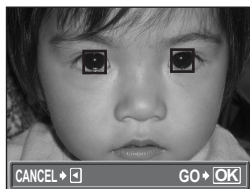

● When [BLACK & WHITE] or [SEPIA] is selected

Select [NEW FILE], and press .

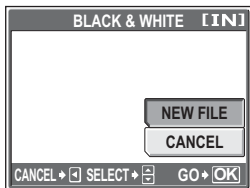

- The [BUSY] bar is displayed and after When [BLACK & WHITE] is selected the image is saved, the camera returns to the playback mode.

! Note

- The following cannot be edited with [], [], [REDEYE FIX], [BLACK & WHITE], or [SEPIA]:
 - If there is insufficient space in the internal memory or the card, or for movies, pictures edited with a computer, or pictures taken with another camera.

Creating composite pictures (FRAME/LABEL/CALENDAR/LAYOUT)



This function lets you add frames, label or a calendar to still pictures and save them as new pictures. You can also create an index layout of selected pictures and save it as a new picture. The following picture composite operations are possible.

- FRAME** Adds a selected frame to a picture and saves it as a new picture.
LABEL Adds a selected label to a picture and saves it as a new picture.
CALENDAR Adds a calendar to a picture and saves it as a new picture.
LAYOUT Creates an index layout of pictures selected in normal playback, album playback or calendar display, and saves it as a new picture.



Top menu ▶ [COMPOSE IMAGE] ▶ [FRAME]/[LABEL]/[CALENDAR]/[LAYOUT] "Using the menus" (P. 19)

1 Select [NEW FILE], and press

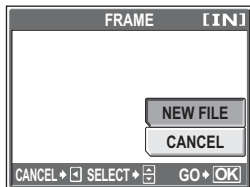

When [FRAME] is selected

2 Add a decoration.

● When [FRAME] is selected

- 1 Press to select a frame, and press .
- 2 Press to select the picture to which you want to add the frame, and press .
 - Press to rotate the picture 90° clockwise or counterclockwise.
- 3 Adjust the position and size of the picture, and press .
 - Adjusts the position of the picture.
 - Zoom lever Adjusts the size of the picture.

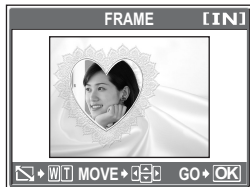
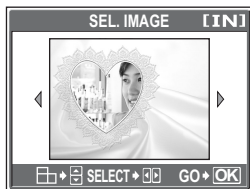

● When [LABEL] is selected

- Press $\triangleleft \triangleright$ to select a picture, and press OK .
- Press $\triangleleft \triangleright$ to select a label, and press OK .
 - Labels created with the LABEL SHOT function (P. 59) are displayed after the internal labels.
 - Press $\triangle \nabla$ to rotate the picture 90° clockwise or counterclockwise.
- Adjust the position and size of the label, and press OK .

$\triangle \nabla \triangleleft \triangleright$ Adjusts the position of the label.

Zoom lever Adjusts the size of the label.
- Press $\triangle \nabla \triangleleft \triangleright$ to select the color of the label, and press OK .



● When [CALENDAR] is selected

- Press $\triangleleft \triangleright$ to select a picture, and press OK .
- Press $\triangleleft \triangleright$ to select a calendar, and press OK .
 - Press $\triangle \nabla$ to rotate the picture 90° clockwise or counterclockwise.
- Set the date of the calendar, and press OK .

$\triangle \nabla$ Changes the settings for year and month.

$\triangleleft \triangleright$ Alternates between the year and month settings.

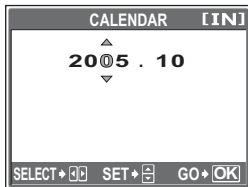
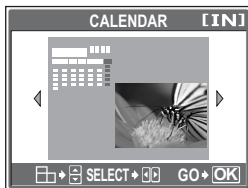

● When [LAYOUT] is selected

- Press $\triangleleft \triangleright$ to select a layout, and press OK .
- Select the type of layout picture, and press OK .

ALL IMAGES All pictures in the internal memory or the card are added to the layout.

$\text{I} \rightarrow \text{S}$ Go to Step 3.

ALBUM All pictures in the selected album are added to the layout.

CALENDAR Select the pictures you want to add to the layout by day from the monthly display.

SEL. IMAGE Select the pictures to be added to the layout individually.

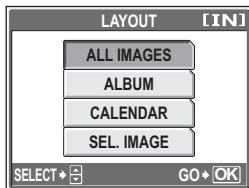

- Select the pictures.

When [ALBUM] is selected

- Press $\triangleleft \triangleright$ to select an album, and press OK .



When [CALENDAR] is selected

- Use the arrow pad to select the day, and press OK .

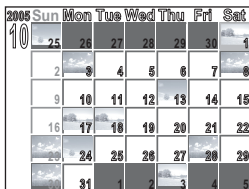

When [SEL. IMAGE] is selected

- Press $\triangleleft \triangleright$ to select a picture, and press OK . Repeat this step and select additional pictures until the screen in Step 3 is displayed.
- Press $\triangle \nabla$ to rotate the picture 90° clockwise or counterclockwise.

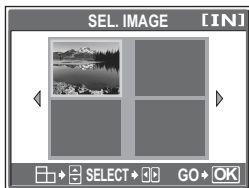

3 Select [OK], and press .

- The [BUSY] bar is displayed and after the image is saved, the camera returns to the playback mode.

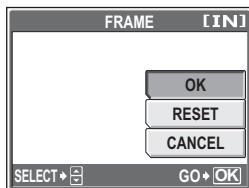

When [FRAME] is selected

Note

- If you select more than two months of calendar in [CALENDAR], the “Month” following the “Year” and “Month” you set in step ③ are set.
- Creating a composite picture with [FRAME], [LABEL], [CALENDAR] or [LAYOUT] is not possible in the following cases:
If there is insufficient space in the internal memory or the card, or for movies, pictures edited with a computer, or pictures taken with another camera.

TIPS

- You can change frames and label using OLYMPUS Master software. For details, refer to the “Help” guide and the OLYMPUS Master reference manual.

Adjusting pictures (BRIGHTNESS, SATURATION, COLOR BALANCE, WARM/COOL)



This function lets you adjust still pictures and store them as new pictures. The following adjustment operations are possible.

- BRIGHTNESS** Adjusts the brightness of a picture and saves the picture as a new file.
- SATURATION** Adjusts the color strength of a picture and saves the picture as a new file.
- COLOR BALANCE** Adjusts individual RGB (Red, Green, Blue) colors in an image and saves it as another image.
- WARM/COOL** Adjust the color of an image and save it as another image.

Select the picture that you want to adjust and display the top menu.



Top menu ▶ [ADJUST IMAGE] ▶ [BRIGHTNESS]/[SATURATION]/[COLOR BALANCE]/[WARM/COOL] “Using the menus” (P. 19)

5
Playback

1 Select [NEW FILE], and press .

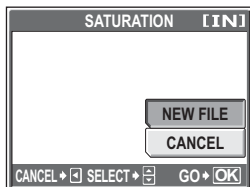

When [SATURATION] is selected

2 Press ∇/Δ to adjust the brightness, colors and tint, and press .

- In WARM/COOL, the colors become warmer when the setting is closer to the W, and cooler when the setting is closer to the C.

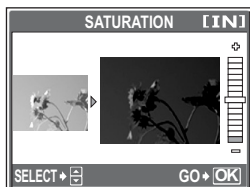

When [SATURATION] is selected

- An adjustment bar to adjust RGB individually is displayed for color balance. Press \triangleleft \triangleright to select.

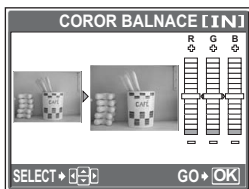

When [COLOR BALANCE] is selected

3 Select [OK], and press .

- The [BUSY] bar is displayed and after the image is saved, the camera returns to the playback mode.

Note

- Adjusting pictures with [BRIGHTNESS], [SATURATION], [COLOR BALANCE] or [WARM/COOL] is not possible in the following cases:
If there is insufficient space in the internal memory or the card, or for movies, pictures edited with a computer, or pictures taken with another camera.

Editing movies



This function lets you create indexes and edit movies.

INDEX 9 frames extracted from a movie are displayed as an index and stored as a still picture.

EDIT This function lets you extract parts of the movie that you want.

Select a movie that you want to edit and display the top menu.

Creating an index



Top menu ▶ [EDIT] ▶ [INDEX]

☞ “Using the menus” (P. 19)

1 Select [NEW FILE], and press

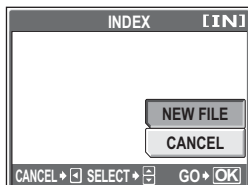

2 Select the first frame of the index, and press .

- △ : Jumps to the first frame of the movie.
- ▽ : Jumps to the last frame of the movie.
- ▶ : Displays the next frame. The movie can be played continuously by holding the button down.
- ◀ : Displays the previous frame. The movie can be played continuously in reverse by holding the button down.



3 As in Step 2, select the last frame of the index, and press .



4 Select [OK], and press .

- The [BUSY] bar is displayed. The 9 frames extracted from the movie are displayed in index format, and the camera returns to playback mode. The index is stored as a new picture.

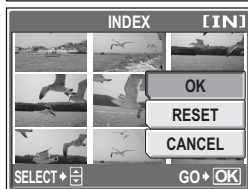

! Note

- The index is stored as a still picture in a different record mode from the original movie.
- The interval between the frames that are automatically extracted varies depending on the length of the movie.
- You cannot create an index if there is insufficient memory space in the internal memory or the card.

Editing a movie



Top menu ▶ [EDIT] ▶ [EDIT]

☞ “Using the menus” (P. 19)

1 Select [NEW FILE] or [OVERWRITE], and press

NEW FILE Stores the edited movie as a new movie.

OVERWRITE Stores the edited movie with the same name as the original. The original movie is not stored.

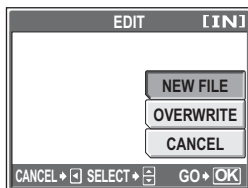

2 Select the first frame of the part you want to keep, and press

△ : Jumps to the first frame of the movie.

▽ : Jumps to the last frame of the movie.

▷ : Displays the next frame. The movie can be played continuously by holding the button down.

◁ : Displays the previous frame. The movie can be played continuously in reverse by holding the button down.



3 As in Step 2, select the last frame of the part you want to keep and press



4 Select [OK], and press .

- The [BUSY] bar is displayed and after the edited movie is stored as a new movie or the original movie is overwritten, the camera returns to the playback mode.



Note

- You cannot select [NEW FILE] if there is insufficient memory space in the internal memory or the card.
- The editing process of long movies is more time-consuming.

Playing back pictures on a TV

Use the provided AV cable to play back recorded images on your TV. You can play back both still pictures and movies on your TV.

- 1 Make sure that the TV and camera are turned off. Connect the multi-connector on the camera to the video and audio input terminals on the TV using the provided AV cable.**

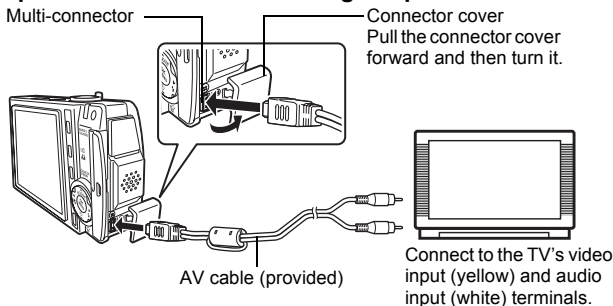

- 2 Turn the TV on, and set it to video input mode.**
 - For details of switching to video input, refer to your TV's instruction manual.
- 3 Set the mode dial to  and press the POWER button to turn the camera on.**
 - The last picture taken is displayed on the TV. Use the arrow pad to select the picture you want to display.
 - The camera's monitor stays off.

? TIPS

- The close-up playback, index display and slideshow functions can also be used on a TV screen.
- It is recommended to use the AC adapter when playing back pictures on a TV.

! Note

- Make sure that the camera's video output signal is the same as the TV's video signal.  "Video output" (P. 90)
- Be sure to use the provided AV cable to connect the camera to the TV.
- The picture may appear off-center on the TV screen.

Video output

You can select [NTSC] or [PAL] according to your TV's video signal type. Use this setting when playing back pictures on a TV in a foreign country. Select the [VIDEO OUT] signal before connecting the video cable. If you select the wrong video signal type, you will not be able to play back the recorded pictures properly on the TV.



Top menu ▶ [MODE MENU] ▶ [SETUP] ▶ [VIDEO OUT] ▶ [NTSC]/[PAL]

"Using the menus" (P. 19)

- For album playback mode: Top menu ▶ [ALBUM MENU] ▶ [VIDEO OUT] ▶ [NTSC]/[PAL]

? TIPS

TV video signal types by country/region

Check the video signal type before connecting the camera to the TV.

NTSC North America, Taiwan, Korea, Japan

PAL European countries, China

Protecting pictures (PROTECT)



It is recommended to protect important pictures to avoid accidentally erasing them.

Protected pictures cannot be erased by the single-frame/selected/all-frame erase function, but they are all erased by formatting.

Select the picture you want to protect and display the top menu.



Top menu ▶ [MODE MENU] ▶ [PLAY] ▶ [O-] ▶ [ON]/[OFF]

"Using the menus" (P. 19)

- For album playback mode: Top menu ▶ [PROTECT] ▶ [ON]/[OFF]
- To cancel protection, select the protected picture and select [OFF].

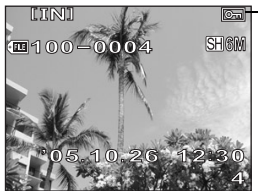

Displayed when a picture is protected.

Copying pictures in the internal memory to the card (BACKUP)

Pictures recorded to the internal memory can be copied to a card (backup). A backup does not erase the pictures in the internal memory.

You need a card to use the backup function. Insert a card into the camera before using this function.



Top menu ▶ [MODE MENU] ▶ [CARD] ▶ [BACKUP]

☞ “Using the menus” (P. 19)

1 Select [YES], and press .

- All image data in the internal memory is copied to the card.

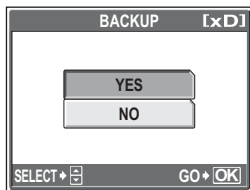

Note

- If there is not enough space left on the card, [CARD FULL] is displayed and backup is canceled.
- When the  mark is blinking, pictures cannot be backed up because of insufficient battery power.
- If the battery power runs out while the camera is backing up the data, the image data may be lost or damaged. It is recommended that you use the AC adapter.
- Never open the battery compartment/card cover or remove the battery while the camera is backing up data. Also, do not connect or disconnect the AC adapter. The internal memory or the card may not operate properly.

Erasing pictures



This function erases recorded pictures. Erasing can be done in the following ways.

- ERASE** Only the frame that is being played back is erased.
- ERASE SELECTED** Multiple frames that you want to erase can be selected and erased. You can select a maximum of 200 images.
- ALL ERASE** All images in internal memory and on the card are erased.

Note

- You cannot erase protected pictures. Cancel protection before erasing such pictures.
- Once erased, pictures cannot be restored. Check each picture before erasing to avoid accidentally erasing pictures you want to keep.  “Protecting pictures (PROTECT)” (P. 91)
- When a picture in an album is erased, it is also erased from the album.

Single-frame erase



1 Select the picture you want to erase, and press the  button.

 “Direct buttons” (P. 12)

2 Select [YES], and press .

- The displayed picture is erased.

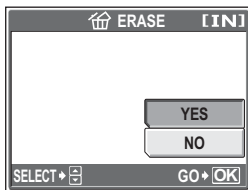

TIPS

- Display the image you want to erase, select top menu ▶ [ERASE] ▶ [ERASE] ▶ [YES] and then press  and the frame is erased.

Erase selected



Top menu ▶ [ERASE] ▶ [ERASE SELECTED] “Using the menus” (P. 19)

1 Use ◀▶ to select the picture you want to erase, and press Δ.

- You can undo the image by pressing Δ again.
- Repeat Step 1 to erase multiple pictures.
- Moving the zoom lever to the T changes the entire screen display, moving it to the W returns the screen display to its original form.

The highlighted picture is enlarged.



A ✓ icon is displayed on the selected picture.

2 When you have selected all the unwanted pictures, press .

3 Select [YES], and press .

- The selected images are erased.

All-frame erase



Top menu ▶ [MODE MENU] ▶ [MEMORY (CARD)] ▶ [ALL ERASE]

“Using the menus” (P. 19)

1

 Select [YES], and press .

- All the pictures are erased.

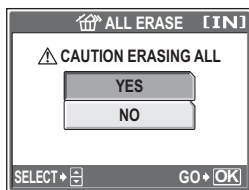

? TIPS

- Select Top menu ▶ [ERASE] ▶ [ALL ERASE] ▶ [YES], and press to erase all the frames.

Formatting the internal memory/card (MEMORY FORMAT/FORMAT)



This function lets you format the internal memory or card. Formatting prepares the internal memory or card to receive data.

- Make sure there is no card inserted in the camera when formatting the internal memory.
- Be sure that the card is inserted in the camera when formatting the card.
- Before using non-OLYMPUS cards or cards which have been formatted on a computer, you must format them with this camera.

All existing image data, including protected pictures, are erased when the internal memory or the card is formatted. Make sure that you save or transfer important data to a computer before formatting the internal memory or card.



Top menu ▶ [MODE MENU] ▶ [MEMORY (CARD)] ▶
[MEMORY FORMAT (FORMAT)]

“Using the menus” (P. 19)

1 Select [YES], and press .

- The [BUSY] bar is displayed while the card is formatted.

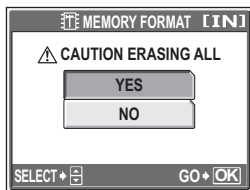

Note

- Do not do any of the following during formatting as such actions may damage the card.
Opening the battery compartment/card cover, connecting or disconnecting the AC adapter (regardless of whether there is a battery in the camera or not)

Settings

6

One of the key features of a digital camera is that you can view the pictures you have taken immediately.

But that isn't all.

For example, you can customize the startup screen with your own picture, and customize various other settings.

You can even change the display language to suit your needs.

Making use of these functions will make such a difference to how much fun you get out of your camera. Why not try them out?

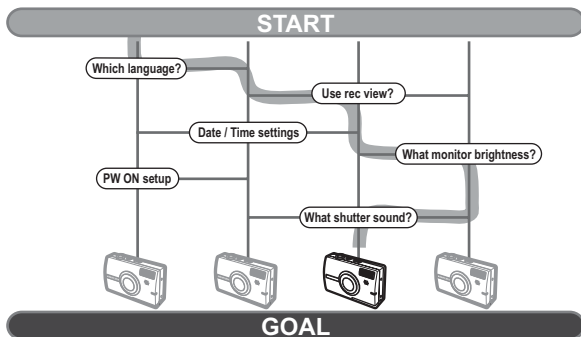

Now you have your very own customized camera!

Resetting the settings to the default (RESET)



The camera retains the changed settings even if the power is turned off. Doing a [RESET] resets the settings (other than the [SETUP] tab in the mode menu) to the factory default settings.



Top menu ▶ [MODE MENU] ▶ [SETUP] ▶ [RESET]

“Using the menus” (P. 19)

1 Select [YES], and press

- Settings are reset to the factory default.

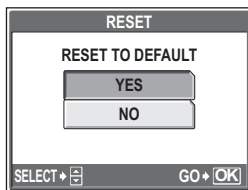

? TIPS

- Select Top menu ▶ [RESET] ▶ [YES], and press to return to default setting.

Selecting a display language



You can select a language for on-screen display. Available languages vary depending on the area where you purchased this camera.



Top menu ▶ [MODE MENU] ▶ [SETUP] ▶ [🗨️]

👉 “Using the menus” (P. 19)

1 Select a language, and press .

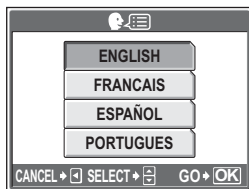

TIPS

To increase the number of languages

→ You can add other languages to your camera with the provided OLYMPUS Master software. For details, refer to the help in the OLYMPUS Master software.

Changing the startup screen and shutdown screen (PW ON SETUP/PW OFF SETUP)

You can select the picture displayed and the sound played when the camera is turned on and turned off. You can also register your favorite picture and display it on the screen.  "Screen setup" (P. 101)





Top menu ▶ [MODE MENU] ▶ [SETUP] ▶ [PW ON SETUP]/
[PW OFF SETUP]

 "Using the menus" (P. 19)

1 For [SCREEN], select [OFF], [1], [2], or [3], and press .

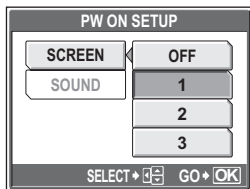
- OFF No picture is displayed.
1 A picture is displayed.
2 The picture registered with [SCREEN SETUP] is displayed. If there is no registered picture, nothing is displayed.
3 The sample pictures in the camera are displayed.



2 For [SOUND], select [OFF], [1], or [2], and press .

- OFF No sound.
1/2 Sound is omitted.
• The volume level is the same as that set with [VOLUME].
 "Setting camera sounds (8/BEEP/SHUTTER SOUND/VOLUME)" (P. 103)

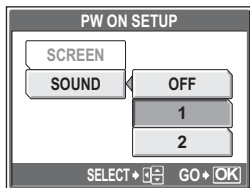

3 Press .

Note

- You can only set [PW ON SETUP] for the [3] of the [SCREEN].

Screen setup

You can select the pictures that are displayed when the power is turned on and turned off. Still pictures in the internal memory or the card can be registered. Use [PW ON SETUP] or [PW OFF SETUP] to display the screen you registered.

 “Changing the startup screen and shutdown screen (PW ON SETUP/PW OFF SETUP)” (P. 100)





Top menu ▶ [MODE MENU] ▶ [SETUP] ▶ [SCREEN SETUP] ▶
[PW ON SETUP]/[PW OFF SETUP]

 “Using the menus” (P. 19)

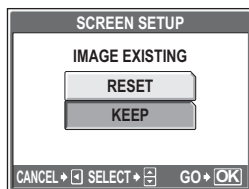
- If a picture is already registered, the [IMAGE EXISTING] screen is displayed asking if you want to cancel the currently registered picture and register a new one. To register a new picture, select [RESET], and press . If you select [KEEP], the screen returns to the menu.



- 1 Select the picture you want to register, and press .
- 2 Select [OK], and press .

- The picture is registered and the screen returns to the menu.

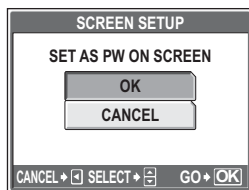

When registering to PW ON screen

Viewing pictures immediately (REC VIEW)

You can choose whether or not to display the picture you have just taken on the monitor.

- OFF** The picture being recorded is not displayed. This is useful when you want to prepare for your next shot while the previous picture is being recorded.
- ON** The picture being recorded is displayed. This is useful for making a brief check of the picture you have just taken. Pressing the shutter button halfway during Rec View lets you resume shooting immediately.



Top menu ▶ [MODE MENU] ▶ [SETUP] ▶ [REC VIEW] ▶ [OFF]/[ON]
👉 “Using the menus” (P. 19)

Setting camera sounds (■)))/BEEP/ SHUTTER SOUND/VOLUME

■)) BEEP

Select [OFF], [LOW] or [HIGH] for the camera warning sound. Select [OFF], [1] or [2] for the sound of the button operations, for example when making menu selections. You can also set the volume of the sound to [LOW] or [HIGH].

SHUTTER SOUND

Select [OFF], [1] or [2] for the sound of the shutter button. You can also set the volume of the sound to [LOW] or [HIGH].

VOLUME

Set the volume for playback of still pictures and movies with sound. There are 5 levels to choose from.



Top menu ▶ [MODE MENU] ▶ [SETUP] ▶ [■))] ▶ [OFF]/[LOW]/[HIGH]

"Using the menus" (P. 19)

● BEEP



Top menu ▶ [MODE MENU] ▶ [SETUP] ▶ [BEEP]

"Using the menus" (P. 19)

1 Select [OFF], [1] or [2]. If you selected [1] or [2], select [LOW] or [HIGH], and press

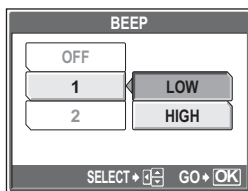

● SHUTTER SOUND



Top menu ▶ [MODE MENU] ▶ [SETUP] ▶ [SHUTTER SOUND]

“Using the menus” (P. 19)

- 1 Select [OFF], [1] or [2].
If you selected [1] or [2], select [LOW] or [HIGH] and press .

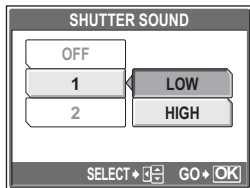

● VOLUME



Top menu ▶ [MODE MENU] ▶ [SETUP] ▶ [VOLUME]

“Using the menus” (P. 19)

- For album playback mode: Top menu ▶ [ALBUM MENU] ▶ [VOLUME]

- 1 Press Δ / ∇ to set the volume, and press .

Resetting file names (FILE NAME)

File names and their folder names for recorded pictures are automatically generated by the camera. File names and folder names respectively include file numbers (0001 to 9999) and folder names (100 to 999), and are named as follows.

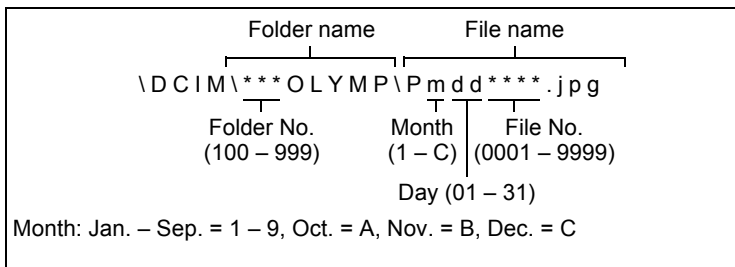

There are two settings from which you can choose: [RESET] or [AUTO]. Choose the one that is best for you when transferring images to a computer.

RESET The file number and folder number are reset every time a new card is inserted in the camera. The folder number returns to No. 100 and the file number returns to No. 0001. This method is useful when grouping files on separate cards.

AUTO Even if a new card is inserted, the folder number and file number are retained from the previous card, so the same file number is not used on different cards. This helps you to manage multiple cards. This method is useful when you want to manage all your files with sequential numbers.



Top menu ▶ [MODE MENU] ▶ [SETUP] ▶ [FILE NAME] ▶ [RESET]/[AUTO]
🔗 “Using the menus” (P. 19)

! Note

- When the File No. reaches 9999, the file number returns to 0001 and the folder number changes.
- When both the folder number and file number reach their respective maximum number (999/9999), the number of storable pictures becomes 0 even if the card is not full. Replace the card with a new one.

Adjusting the image processing function (PIXEL MAPPING)

The pixel mapping feature allows the camera to check and adjust the CCD and image processing functions. It is not necessary to operate this function frequently. Approximately once a year is recommended. Wait at least one minute after taking or viewing pictures to allow the pixel mapping function to perform properly.



Top menu ▶ [MODE MENU] ▶ [SETUP] ▶ [PIXEL MAPPING]

"Using the menus" (P. 19)

1 Press . When [START] is displayed, press .

- The [BUSY] bar is displayed during pixel mapping. When pixel mapping is finished, the screen returns to the mode menu.

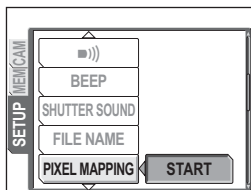

When in [SHOOTING STILL PICTURES MODE]

Note

- If you turn the camera off during pixel mapping, start again from Step 1.

Adjusting the monitor brightness



This function lets you adjust the brightness of the monitor to make it easier to see the image.



Top menu ▶ [MODE MENU] ▶ [SETUP] ▶ [!☺]

“Using the menus” (P. 19)

• For album playback mode: Top menu ▶ [ALBUM MENU] ▶ [!☺]

1 Adjust the brightness while looking in the monitor, and when you have set the desired level, press .

- Pressing brightens the monitor, and pressing darkens it.



Setting the date and time



This function lets you set the date and time. The date and time is saved with each image, and is used in the file name.



Top menu ▶ [MODE MENU] ▶ [SETUP] ▶ [!🕒]

“Using the menus” (P. 19)

1 Select one of the following date formats: [Y-M-D] (Year/Month/Day), [M-D-Y] (Month/Day/Year), [D-M-Y] (Day/Month/Year), and press .

- The camera proceeds to the year setting.
- The following steps show the procedure used when the date and time settings are set to [Y-M-D].

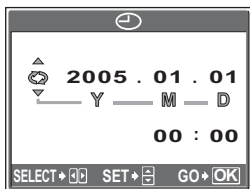

2 Press Δ / ∇ to set the year, and press \triangleright to move to the month setting.

- To move back to the previous setting, press \triangleleft .
- The first two digits of the year are fixed.

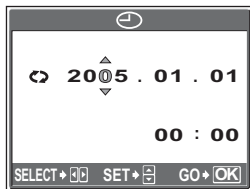

3 Repeat this procedure until the date and time are completely set.

- The time is displayed in the 24-hour format. Consequently, 2 p.m. is displayed as 14:00.

4 Press OK (MENU).

- For a more accurate setting, press OK (MENU) when the time signal hits 00 seconds.

! Note

- The date and time settings will be returned to the factory default settings if the camera is left without the battery for approximately 1 day. The settings will be canceled more quickly if the battery was only loaded in the camera for a short time before being removed. Before taking important pictures, check that the date and time settings are correct.

Setting the date and time in another time zone (DUAL TIME SETUP)

This function allows you to set a date and time in another time zone (dual time), separate from the settings in [DUAL TIME SETUP] . After setting, you can switch between the new setting and the time set in [DUAL TIME SETUP] .



Top menu \triangleright [MODE MENU] \triangleright [SETUP] \triangleright [DUAL TIME SETUP]

 "Using the menus" (P. 19)

● Setting dual time

1 Select [ON], and press \triangleright .

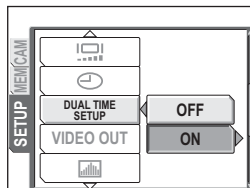

When in [SHOOTING STILL PICTURES MODE]

2 Press Δ / ∇ to set the year, and press \triangleright to move to the month setting.

- To move back to the previous setting, press \triangleleft .
- The first two digits of the year are fixed.
- The date format is the same as that set in Step 1 of [⌚].

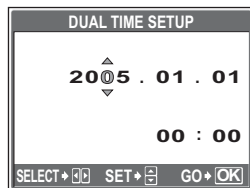

3 Repeat this procedure until the date and time are completely set.

- The time is displayed in the 24-hour format. Consequently, 2 p.m. is displayed as 14:00.

4 Press OK .

- For a more accurate setting, press OK when the time signal hits 00 seconds.
- The date and time switches to dual time.

● Switching the date and time

1 Select [ON] or [OFF], and press OK .

OFF Switches to the date and time set in [⌚].

ON Switches to the date and time set in [DUAL TIME SETUP].

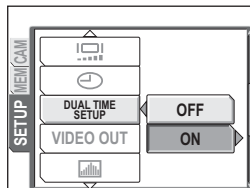

? TIPS

- Changes made to [⌚] do not affect the date and time set in [DUAL TIME SETUP].
- After setting the date and time with [DUAL TIME SETUP], it is retained even after [DUAL TIME SETUP] is set to [OFF].

Displaying a picture automatically (SCREEN SAVER)

You can have the pictures in the card or internal memory automatically display one at a time if no operations are done in the playback mode for a set time.



Top menu ▶ [MODE MENU] ▶ [SETUP] ▶ [SCREENSAVER]

 "Using the menus" (P. 19)

1 Select either [ON] or [OFF], and press .

OFF No display
ON Display

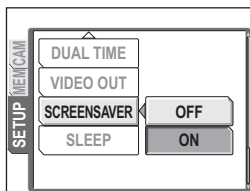

? TIPS

- The time set until the [SCREENSAVER] comes on is the same time as is set for the [SLEEP] ( P. 111).
- The screensaver turns off as soon as you operate the shutter button or zoom lever.
- If no pictures have been taken, a warning is displayed and the default images pre-stored in the camera are displayed.
- If one picture has been taken, the image taken and the default images pre-stored in the camera are displayed.

! Note

- In the following cases the [SCREENSAVER] does not turn [ON] even if it is set. Menus are displayed/movie is playing/slideshow is playing/USB cable is connected.

Setting the sleep time (SLEEP)

If no operations are performed for a certain period of time while the camera is running on batteries, the camera enters sleep mode (standby) and stops operating. You can set the time until the camera enters sleep mode.



Top menu ▶ [MODE MENU] ▶ [SETUP] ▶ [SLEEP]

"Using the menus" (P. 19)

- 1 Select [30SEC], [1MIN], [3MIN], [5MIN] or [10MIN], and press .

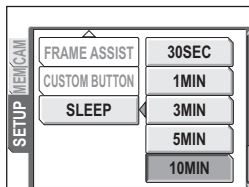



You can set commonly used functions to the custom button. When a function is set to the custom button, you can simply press the custom button to display the setting screen for that function without having to go through the menu.

Functions that can be assigned to the custom button	Options	Ref. page
COMPARE & SHOOT	OFF, ON	P. 50
DRIVE	, , MULTI-SHOT	P. 55
DIGITAL ZOOM	OFF, ON	P. 41
METERING	AUTO,	P. 54
AF MODE	AUTO, SPOT	P. 56
	-2.0 – +2.0	P. 52
ISO	AUTO, 64, 100, 200, 400	P. 51
(still pictures)	OFF, ON	P. 60
	Still picture: SUPER HIGH6M, HIGH 4M, HIGH 2M, BASIC 1M, E-MAIL VGA Movie: FINE, STANDARD, EXTENDED	P. 26
WB	AUTO, , , ,	P. 53
FULLTIME AF	OFF, ON	P. 48
(movies)	OFF, ON	P. 48
(IMAGE STABILIZER)	OFF, ON	P. 47

Setting the custom button



Top menu ▶ [MODE MENU] ▶ [SETUP] ▶ [CUSTOM BUTTON]

☞ “Using the menus” (P. 19)

1 Select a function, and press .

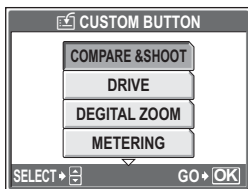

Note

- ,  and  cannot be set separately.

Using the custom button



1 Press the  button.

☞ “Direct buttons” (P. 12)

- The menu of the set function is displayed.

2 Press the  button repeatedly to set it.

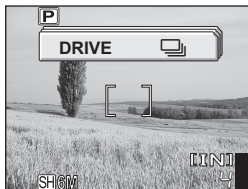

When [DRIVE] is set on the [CUSTOM BUTTON]

7

Printing pictures

You can print out the pictures you have taken either at a photo store or at home on your own printer.

If you go to a photo store, it is a good idea to store the print reservation data on the card first. This lets you select the pictures you want to print and decide how many prints you want. If you print the pictures at home, you can either connect the camera directly to the printer or you can connect the camera to a computer and download the pictures to the computer first.

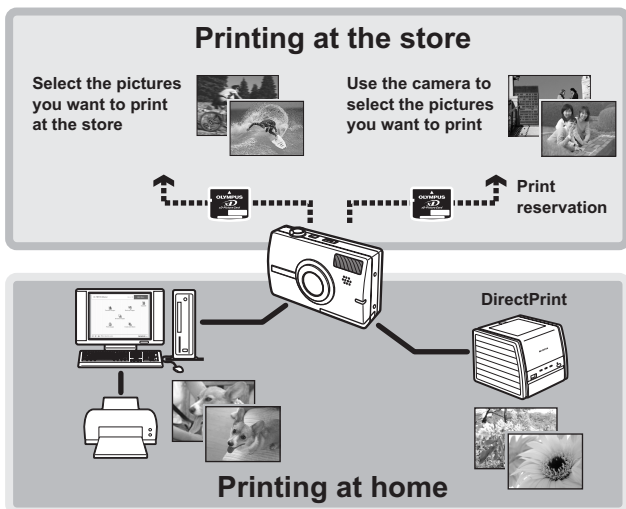

Using the direct printing function

By connecting the camera to a PictBridge-compatible printer with the USB cable, you can print out recorded pictures directly. With the camera connected to the printer, select the pictures you want to print and the number of prints on the camera's monitor.  "Printing pictures (EASY PRINT)" (P. 116)

With [CUSTOM PRINT], you can print out pictures with the set number of prints, print paper and other settings.  "Printing pictures (CUSTOM PRINT)" (P. 118)

It is also possible to print out pictures using the print reservation data.

 "Print settings (DPOF)" (P. 125)

To find out if your printer is compatible with PictBridge, refer to the printer's instruction manual.

What is PictBridge?... It is the standard for connecting digital cameras and printers of different manufacturers and printing out pictures directly.

STANDARD... All printers that support PictBridge have standard print settings. If [STANDARD] is selected on the settings screens (P. 119 to 123), pictures are printed according to these settings. Refer to the printer's instruction manual for its standard settings or contact the printer manufacturer.

TIPS

- For details of printing paper types, ink cassettes, etc., refer to the printer's instruction manual.

Note

- It is recommended to use the AC adapter when printing pictures. If you use the battery, make sure that it is sufficiently charged. If the camera stops operating while communicating with the printer, the printer may malfunction or image data may be lost.
- Movies cannot be printed.
- The camera will not enter sleep mode when connected to a printer with the USB cable.

Print modes and settings

Available printing modes, paper sizes etc., vary depending on the printer you use. Refer to the instruction manual for your printer.

Printing pictures (EASY PRINT)

Use the provided USB cable to connect the camera to a PictBridge-compatible printer.

[EASY PRINT] can be used to print out the picture displayed on the monitor.



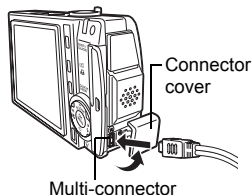
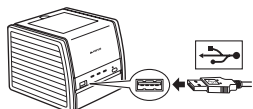

- 1** Power on the printer.
- 2** In playback mode, display the picture you want to print out on the monitor.
- 3** Connect one end of the provided USB cable into the camera's multi-connector and the other end into the printer's USB connector.

- Pull the connector cover forward and then turn it.
- The [EASY PRINT START] screen is displayed.
- For details of how to turn the printer on and the position of the USB port, refer to the printer's instruction manual.



- 4** Press the  button.

- Printing starts.
- When printing is finished, the picture selection screen is displayed. To print another picture, press  to select a picture, and press the  button.
- When you are finished, disconnect the USB cable from the camera. Do not disconnect the USB cable while printing pictures.



- 5** Remove the USB cable from the camera.

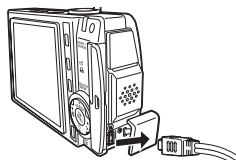

- 6** Remove the USB cable from the printer.

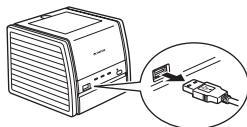

? TIPS

- You can use [EASY PRINT] even when the camera is turned off or in shooting mode. With the camera turned off or in shooting mode, connect the USB cable. The selection screen for the USB connection is displayed. Select [EASY PRINT].  "Printing pictures (CUSTOM PRINT)" Step 3 (P. 118), "Printing pictures (EASY PRINT)" Step 4 (P. 116)

Printing pictures (CUSTOM PRINT)

Try printing one picture with the most basic printing method of [CUSTOM PRINT]. The selected picture is printed using the standard settings of your printer. The date and file name are not printed.

- 1 Power on the printer.
- 2 Connect one end of the provided USB cable into the camera's multi-connector and the other end into the printer's USB connector.

- Pull the connector cover forward and then turn it.
- The camera turns on automatically.
- The monitor turns on and the selection screen for the USB connection is displayed.
- For details of how to turn the printer on and the position of the USB port, refer to the printer's instruction manual.

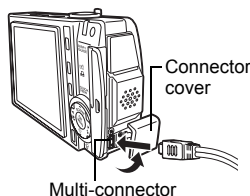
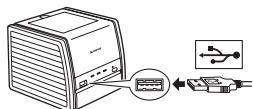

- 3 Select [CUSTOM PRINT], and press .

- [ONE MOMENT] is displayed and the camera and printer are connected. The [PRINT MODE SELECT] screen is displayed on the camera's monitor. Select the print settings on the camera's monitor.
 - Select [EASY PRINT], and press .
- The picture selection screen is displayed.
- "Printing pictures (EASY PRINT)" Step 4 (P. 116)

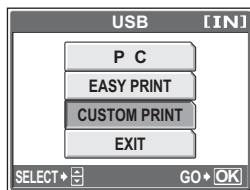

● To select the pictures to print

When there is a card in the camera, a screen is displayed for selecting the pictures you want to print.

Select [ALL IMAGES] or [ALBUM], and press . To search for the picture from an album, select [ALBUM], and press .

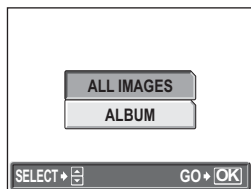

4 Select [PRINT], and press .

- The [PRINTPAPER] screen is displayed.
- When the [PRINTPAPER] screen is not displayed, go to Step 6.

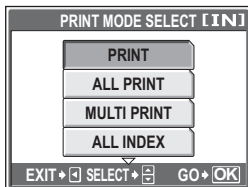

5 Press without changing the [SIZE] or [BORDERLESS] settings.

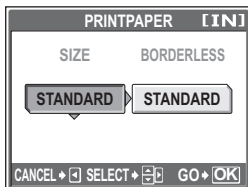

6 Press to select a picture, and press .

- [SINGLE PRINT] is set.



7 Press .

- The [PRINT] screen is displayed.

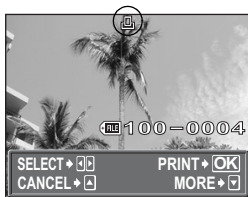

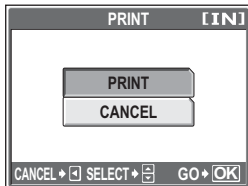

8 Select [PRINT], and press .

- Printing starts.
- When printing is finished, the [PRINT MODE SELECT] screen is displayed.



● To cancel printing

Pressing  during print data transfer displays the screen for selecting whether to continue or cancel printing. To cancel printing, select [CANCEL] and press .

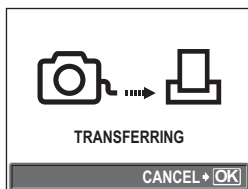

Screen during data transfer

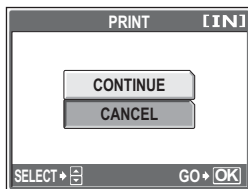

9 In the [PRINT MODE SELECT] screen, press .

- A message is displayed.

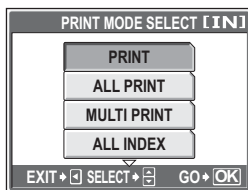

10 Remove the USB cable from the camera.

- The camera turns off.

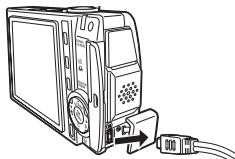

11 Remove the USB cable from the printer.

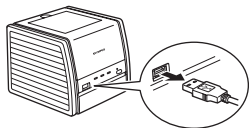

Other print modes and print settings

In addition to the basic printing method, there are also several other printing modes. The paper size and borderless settings can be set in the same print mode. If the following screen is displayed, perform the operations according to the operation guide.

Selecting the picture to print (available only when a card is inserted)

- ALL IMAGES** Allows you to select from all pictures in the internal memory or the card to print.
- ALBUM** Select an album and the pictures in the album to print.

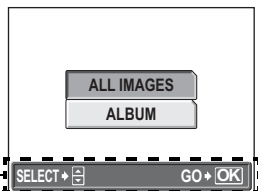

Operation guide

Selecting a print mode

- PRINT** Prints the selected picture.
- ALL PRINT** Prints all the pictures stored in the internal memory or the card.
- MULTI PRINT** Prints one picture in multiple layout format.
- ALL INDEX** Prints an index of all the pictures stored in the internal memory or the card.
- PRINT ORDER** Prints pictures according to print reservations. If no print reservations have been made, this option is not available.
 "Print settings (DPOF)" (P. 125)

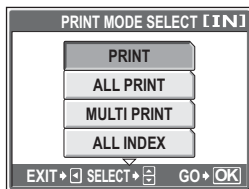

Setting the print paper

Select the paper size and border on the [PRINTPAPER] screen.

- SIZE** Choose from the available paper sizes on your printer.
- BORDERLESS** Select framed or unframed. In [MULTI PRINT] mode, you cannot select the frame.
- OFF** () The picture is printed inside a blank frame.
- ON** () The picture is printed filling the entire page.
- PICS/SHEET** Available in [MULTI PRINT] mode only. The number of prints that can be printed vary depending on the printer.

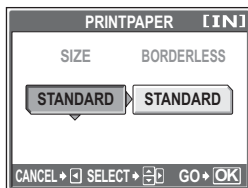

! Note

- If the [PRINTPAPER] screen is not displayed, [SIZE], [BORDERLESS] and [PICS/SHEET] are set to [STANDARD].

Selecting the picture to print

Press <> to select the picture you want to print. You can also use the zoom button and select a picture from the index display.

- PRINT** Prints one copy of the selected picture.
- SINGLE PRINT** Makes a print reservation for the displayed picture.
- MORE** Sets the number of prints and data to be printed for the displayed picture.

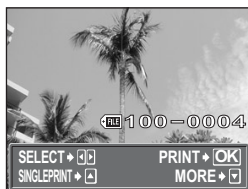

Setting the number of prints and data to be printed [MORE]

- Sets the number of prints. You can select up to 10 prints.
- DATE** (🕒) If you select [WITH], pictures are printed with the date.
- FILE NAME** (📄) If you select [WITH], pictures are printed with the file name.
- Crops part of a picture and prints it.

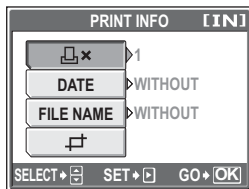

Setting the trimming position and size [📏]

- ① Use the zoom lever to select the trimming size and the arrow pad to set the trimming position, and then press .
- ② Select [OK], and press .









Note

- The size of the picture that is printed depends on your printer's setting. If the cropped area of the picture is small, the magnification of the image increases when you print, creating a grainy picture.
- It is recommended to take a picture in SUPER HIGH6M or HIGH 4M record mode if you want to create a detailed, enlarged print of the picture.

If an error message is displayed

If an error message is displayed on the camera's monitor during direct print setting or printing, see the following table.

For more details, refer to the printer's instruction manual.

Monitor indication	Possible cause	Corrective action
 NO CONNECTION	The camera is not connected to the printer correctly.	Disconnect the camera and connect it again correctly.
 NO PAPER	There is no paper in the printer.	Load some paper in the printer.
 NO INK	The printer has run out of ink.	Replace the ink cartridge in the printer.
 JAMMED	The paper is jammed.	Remove the jammed paper.
SETTINGS CHANGED	The printer's paper tray has been removed or the printer has been operated while changing settings on the camera.	Do not operate the printer while changing settings on the camera.
 PRINT ERROR	There is a problem with the printer and/or camera.	Turn off the camera and printer. Check the printer and remedy any problems before turning the power on again.
 CANNOT PRINT	Pictures taken with other cameras may not be printed on this camera.	Use a computer to print.

? TIPS

- If an error message other than those shown above is displayed, see "Error messages" (P. 147).



How to make print reservations

Print reservation allows you to save printing data (the number of prints and the date and time information) with the pictures stored on the card.

Only images stored on the card can be reserved to print. Insert a card with recorded pictures into the camera before making print reservations.

With print reservation, you can print out pictures easily either at home using a personal DPOF-compatible printer or at a photo store that supports DPOF. DPOF is a standard format used to record automatic print information from digital cameras. It allows you to store data such as which pictures you want to print and the number of prints so that you can print pictures automatically at home or at a photo store.

Pictures with print reservations can be printed using the following procedures.

Printing using a DPOF-compatible photo store.

You can print the pictures using the print reservation data.

Printing using a DPOF-compatible printer.

Printing is possible directly from a card containing print reservation data, without using a computer. For more details, refer to the printer's instruction manual. A PC card adapter may also be necessary.

To use print services without using DPOF

Pictures stored in the internal memory cannot be printed at a photo store. The pictures need to be copied to a card before taking them.



"Copying pictures in the internal memory to the card (BACKUP)" (P. 92)

? TIPS**Relation between printing and record mode when shooting**

The resolution of a computer/printer is generally based on the number of dots (pixels) per inch (dpi). The higher the dpi value, the better the printed results. Keep in mind, however, that the number of pixels does not change. This means that when you print an image with a higher dpi value, the size of the printed picture will be smaller. Although you can print magnified images, picture quality will decrease.

If you want to print large, high-quality pictures, set the record mode as high as possible when taking the pictures.  "Record mode (IMAGE QUALITY)" (P. 26)

! Note

- DPOF reservations set by another device cannot be changed by this camera. Make changes using the original device.
- If a card contains DPOF reservations set by another device, entering reservations using this camera may overwrite the previous reservations.
- If there is not enough space in the card memory, you may not be able to enter the reservation data. [CARD FULL] will be displayed.
- You can make DPOF print reservations for up to 999 images per card.
- Even if an image is displayed with the message [PICTURE ERROR], it may be possible to make print reservations. In this case, the print reservation icon () is not displayed when the image is displayed for full view.  is displayed when there are multiple images (index display), allowing you to confirm the print reservation.
- Not all functions may be available on all printers, or at all photo stores.
- Print reservation may take a little time when saving printing data to the card.

Single-frame reservation



How to make a single-frame reservation for a selected picture is shown below. Follow the operation guide to adjust settings.

For album playback mode, select the album that you want to make the print reservation for, and display the top menu.



Top menu ▶ [MODE MENU] ▶ [PLAY] ▶ [] “Using the menus” (P. 19)

- For album playback mode: Top menu ▶ [ALBUM MENU] ▶ []

1 Select [], and press .

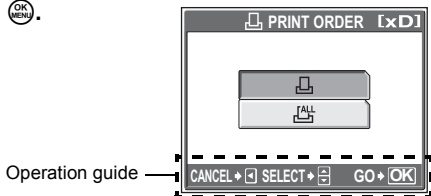

2 Follow the operation guide and press \triangle/∇ to select the frames for print reservations, and then press \triangle/∇ to set the number of prints.

- You cannot make print reservations for pictures with .
- Repeat Step 2 to make print reservations for other pictures.

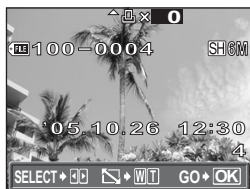

● Trimming pictures

- ① Turn the zoom lever toward W or T.
 - The trimming frame is displayed.
- ② Use the zoom lever to select the trimming size and the arrow pad to set the trimming position, and then press .
- ③ Select [OK], and press .

3 When you finish making print reservations, press .

4 Select [NO], [DATE] or [TIME], and press .

NO The pictures are printed without the date and time.

DATE The selected pictures are printed with the shooting date.

TIME The selected pictures are printed with the shooting time.

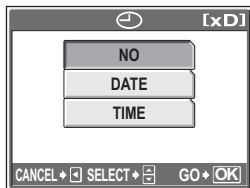

5 Select [SET], and press .

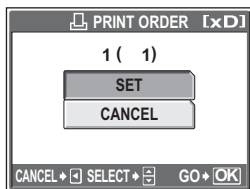

All-frame reservation



Reserves all the pictures stored on the card. The number of prints is set at one print per picture. You can set to print the shooting date and time.

For album playback mode, print reservations are made for all pictures in the album. Select the album that you want to make the print reservations for, and display the top menu.

7



Top menu ▶ [MODE MENU] ▶ [PLAY] ▶   “Using the menus” (P. 19)

- For album playback mode: Top menu ▶ [ALBUM MENU] ▶ 

1 Select , and press .

2 Select [NO], [DATE] or [TIME], and press .

NO The pictures are printed without the date and time.

DATE All pictures are printed with the shooting date.

TIME All pictures are printed with the shooting time.

3 Select [SET], and press .

Resetting print reservation data



This function allows you to reset the print reservation data. You can reset all the print reservation data or just for selected pictures.



Top menu ▶ [MODE MENU] ▶ [PLAY] ▶ [] ⓘ “Using the menus” (P. 19)

• For album playback mode: Top menu ▶ [ALBUM MENU] ▶ []

● To reset the print reservation data for all pictures

- 1 Select [] or [ALL], and press
- 2 Select [RESET], and press .
 - If there is no print reservation data, this screen is not displayed.

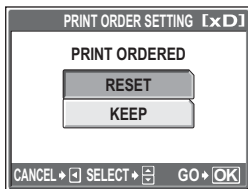

● To reset the print reservation data for a selected picture

- 1 Select [], and press .
- 2 Select [KEEP], and press .
 - If there is no print reservation data, this screen is not displayed.
- 3 Press ◀▶ to select the picture with the print reservations you want to cancel, and press ▼ to decrease the number of prints to 0.
 - Repeat Step 3 to cancel print reservations for other pictures.
- 4 When you are finished canceling print reservations, press .
- 5 Select [NO], [DATE] or [TIME], and press .
 - The setting is applied to the remaining pictures with print reservations.
- 6 Select [SET], and press .

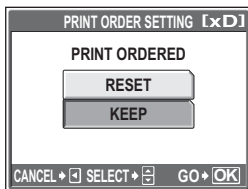

Connecting the camera to a computer

Viewing the pictures you have taken on your computer is just one of the many ways you can enjoy your pictures.

You can print out your favorite pictures, use the application software to download your pictures from your camera and edit them or organize them by date or category, or attach them to e-mail and send them over the Internet.

There are all kinds of ways you can use your pictures with a computer. You can run a slideshow, post your pictures on your home page, create an album, or set your favorite picture as your desktop wallpaper.

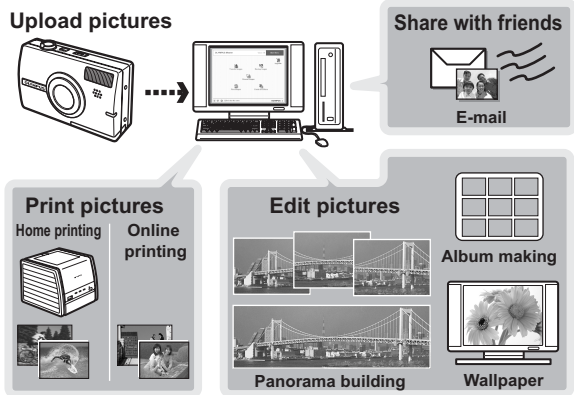

Flow

Using the USB cable provided with your camera, you can connect the camera to a computer and download (transfer) the images to your computer using the OLYMPUS Master software, also provided with the camera.

Prepare the following items before starting.

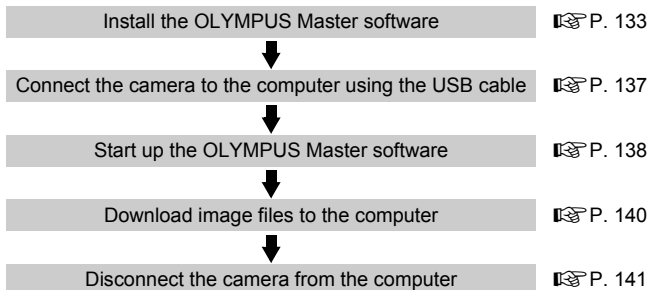
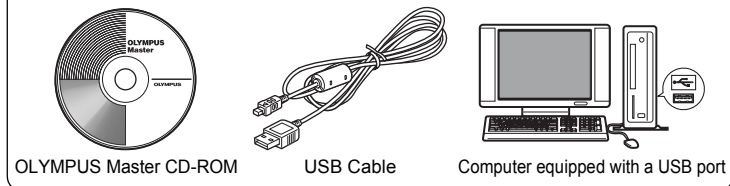

? TIPS

Viewing and editing downloaded images

→ If you want to process images using graphics applications, make sure you download the images to your computer first. Depending on the software, the image files may be damaged if the images are processed (rotated, etc.) while they are still in the internal memory or on the card.

If the data cannot be downloaded from the camera using the USB cable

→ Image files on xD-Picture Card may be downloaded using the optional PC card adapter. For details, visit the Olympus web site at the address shown on the back cover of this manual.

! Note

- It is recommended that you use the AC adapter when connecting the camera to a computer. If you use a battery, make sure it has enough power. The camera does not turn off automatically while it is connected to (communicating with) a computer. If the battery power runs out, the camera will stop whatever operation it is performing. This may result in a computer malfunction, or loss of image data (file) being transmitted.
- Do not turn the camera off while it is connected to the computer. Doing so could cause the computer to malfunction.
- Connecting the camera to a computer via a USB hub may cause unstable operation if there is any problem with compatibility between the computer and the hub. In this case, do not use a hub, but connect the camera directly to the computer.

Using OLYMPUS Master

For editing and managing image files, install the OLYMPUS Master software from the provided CD-ROM.

What is OLYMPUS Master?

OLYMPUS Master is application software for editing images taken with a digital camera on a computer. Installing it on your computer lets you do the following:

Download images from the camera or other media

Manage images

You can organize your images using the calendar display. Search the image you want by date or keyword.

View images and movies

You can run a slideshow and playback movies.

Edit images

You can rotate images, trim them and change the size.



Edit images with the filter and correction functions

Make panoramic images

You can make panoramic images using pictures taken in panorama mode.

Print images

You can print images and make indexes, calendars and postcards.

For details of functions and operations other than the above, refer to the "Help" guide and OLYMPUS Master reference manual.

Installing OLYMPUS Master

Before installing the OLYMPUS Master software, please confirm that your computer is compatible with the following system requirements. For newer operating systems, please refer to the Olympus web site as shown on the back cover of this manual.

● Operating environment

Windows

OS	Windows 98SE/Me/2000 Professional/XP
CPU	Pentium III 500 MHz or later
RAM	128 MB or more (at least 256 MB is recommended)
Hard disk capacity	300 MB or more
Connector	USB port
Monitor	1,024 × 768 pixels, 65,536 colors or more



Note

- Data transfer is only guaranteed on computers with a factory installed OS.
- To install the software in Windows 2000 Professional/XP, you must log on as a user with administrators' privileges.
- Internet Explorer and QuickTime 6 or later should be installed on your computer.
- Windows XP corresponds to Windows XP Professional/Home Edition.
- Windows 2000 corresponds to Windows 2000 Professional.
- If you are using Windows 98SE, the USB driver is installed automatically.

Macintosh

OS	Mac OS X 10.2 or later
CPU	Power PC G3 500 MHz or later
RAM	128 MB or more (at least 256 MB is recommended)
Hard disk capacity	300 MB or more
Connector	USB port
Monitor	1,024 × 768 pixels, 32,000 colors or more

Note

- Operation is only guaranteed on a Macintosh equipped with a built-in USB port.
- QuickTime 6 or later and Safari 1.0 or later must be installed.
- Be sure to remove the media (drag & drop onto the trash icon) before performing the following operations. Failure to do so could result in unstable computer operation and the need to reboot.
 - Disconnect the cable connecting the camera to the computer
 - Turn off the camera
 - Open the camera's battery compartment/card cover

Windows**1** Insert the CD-ROM into the CD-ROM drive.

- The OLYMPUS Master setup screen is displayed.
- If the screen is not displayed, double-click the "My Computer" icon and click the CD-ROM icon.

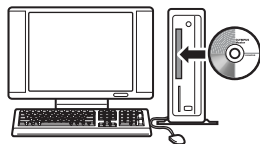
**2** Click the "OLYMPUS Master".

- The QuickTime installation screen is displayed.
- QuickTime is required to use OLYMPUS Master. If the QuickTime screen is not displayed, QuickTime 6 or later is already installed on the computer. In this case, go to Step 4.

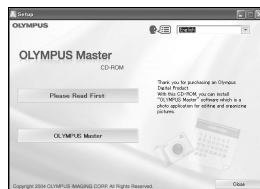

3 Click “Next” and follow the on-screen instructions.

- When the QuickTime licensing agreement is displayed, read the agreement and click “Agree” to proceed with the installation.
- The OLYMPUS Master installation screen is displayed.

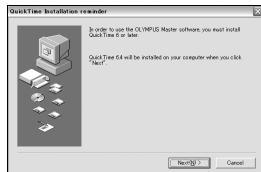

4 Follow the on-screen instructions.

- When the OLYMPUS Master licensing agreement is displayed, read the agreement and click “Yes” to proceed with the installation.
- When the “User Information” dialog box is displayed, enter your “Name” and “OLYMPUS Master Serial Number”; select your region and click “Next”. Refer to the sticker on the CD-ROM package for the serial number.
- When the DirectX licensing agreement is displayed, read the agreement and click “Yes”.
- A screen asking whether or not you want to install Adobe Reader is displayed. Adobe Reader is required to read the OLYMPUS Master instruction manual. If this screen is not displayed, Adobe Reader is already installed on your computer.

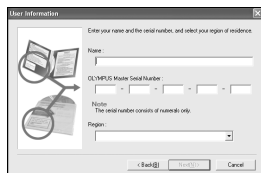
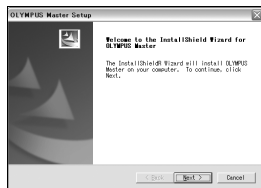

5 To install Adobe Reader, click “OK”.

- To cancel installation, click “Cancel”. Go to Step 7.
- The Adobe Reader installation screen is displayed. Follow the on-screen instructions.

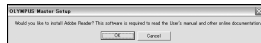

6 Follow the on-screen instructions.

- The screen confirming that installation is completed is displayed. Click "Finish".

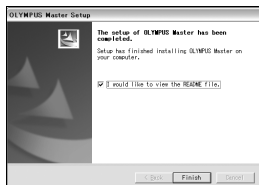

7 Select the option to restart immediately when the screen asking you if you wish to restart the computer is displayed and click "OK".

- The computer restarts.
- Remove the CD-ROM from the CD-ROM drive and store it.

Macintosh

1 Insert the CD-ROM into the CD-ROM drive.

- The CD-ROM window is displayed.
- If the CD-ROM window is not displayed, double-click the CD-ROM icon on the desktop.



2 Double-click on the desired language folder.

3 Double-click the "Installer" icon.

- The OLYMPUS Master installer starts up.
- Follow the on-screen instructions.
- When the OLYMPUS Master licensing agreement is displayed, read the agreement and click "Continue" and then "Agree" to proceed with the installation.
- The screen confirming that installation is completed is displayed.



4 Click "Finish".

- The first screen is displayed.

5 Click "Restart".

- The computer restarts.
- Remove the CD-ROM from the CD-ROM drive and store it.

Connecting the camera to a computer

Connect the camera to the computer using the USB cable provided with the camera.

1 Make sure the camera is turned off.

- The monitor is off.
- The lens cover is closed.
- The power/card access lamp is off.

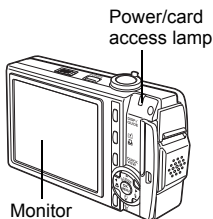

2 Plug the USB cable into the USB port on the computer.

- Refer to your computer's instruction manual to locate the position of the USB port.

3 Plug the USB cable into the multi-connector of the camera.

- Pull the connector cover forward and then turn it.
- The camera turns on automatically.
- The monitor turns on and the selection screen for the USB connection is displayed.

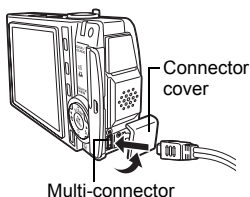

4 Select [PC], and press .

5 The camera is recognized by the computer.

- Windows
When you connect the camera to your computer for the first time, the computer attempts to recognize the camera. Click "OK" to exit the message that is displayed. The camera is recognized as a "Removable Disk".
- Macintosh
The iPhoto program is the default application for managing digital images. When you connect your digital camera for the first time, the iPhoto application starts automatically, so close this application and start OLYMPUS Master.

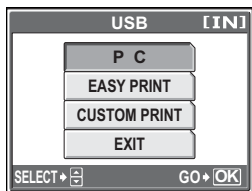

Note

- The camera functions are disabled while the camera is connected to a computer.

Starting up OLYMPUS Master

Windows

1 Double-click the “OLYMPUS Master” icon  on the desktop.

- The main menu is displayed.
- When OLYMPUS Master is started up for the first time after installation, the “Registration” dialog box is displayed before the main menu. Follow the prompts and fill in the registration form.

Macintosh

1 Double-click the “OLYMPUS Master” icon  in the “OLYMPUS Master” folder.

- The main menu is displayed.
- When OLYMPUS Master is started up for the first time, the “User Information” dialog box is displayed before the main menu. Enter your “Name” and “OLYMPUS Master Serial Number”, and select your region.
- After the “User Information” dialog box, the “Registration” dialog box is displayed. Follow the prompts and fill in the registration form.

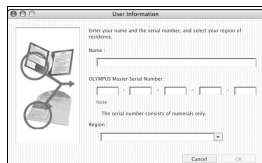

● OLYMPUS Master main menu

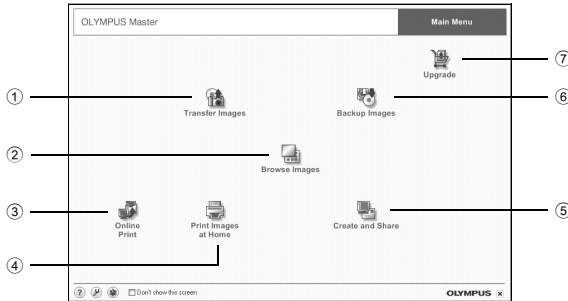

- ① **“Transfer Images” button**
Downloads images from the camera or other media.
- ② **“Browse Images” button**
Displays the browse window.
- ③ **“Online Print” button**
The online print window is displayed.
- ④ **“Print Images at Home” button**
Displays the print menu.
- ⑤ **“Create and Share” button**
Displays the editing menu.
- ⑥ **“Backup Images” button**
Creates backup images.
- ⑦ **“Upgrade” button**
Displays window for optional upgrade to OLYMPUS Master Plus.

● To exit OLYMPUS Master

1 Click the “Exit”  on the main menu.

- OLYMPUS Master is exited.

Displaying camera images on a computer

Downloading and saving images

You can save your images on your computer.

1 Click “Transfer Images”  on the OLYMPUS Master main menu.

- The menu for selecting the source is displayed.

2 Click “From Camera” .

- The window for selecting images is displayed. All the images in the camera are displayed.

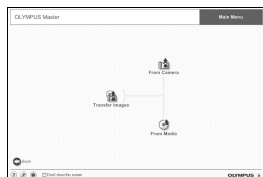

3 Select the image files and click “Transfer Images”.

- A window indicating that the download is complete is displayed.

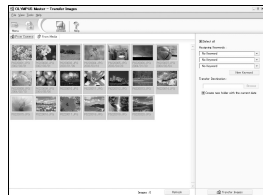

4 Click “Browse images now.”.

- The downloaded images are displayed in the browse window.
- To return to the main menu, click “Menu” in the “Browse” window.

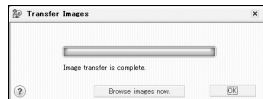

Note

- The power/card access lamp blinks while downloading images. Do not do any of the following while the lamp is blinking.
 - Open the battery compartment/card cover.
 - Connect or disconnect the AC adapter.

● To disconnect the camera

You can disconnect the camera after downloading the images to your computer.

- 1 Make sure that the power/card access lamp has stopped blinking.**

Power/card access lamp

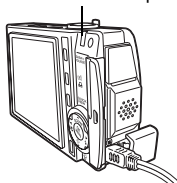

- 2 Make the following preparations for disconnecting the USB cable.**

Windows 98SE

- 1 Double-click the "My Computer" icon and right-click the "Removable Disk" icon to display the menu.
- 2 Click "Eject" on the menu.



Windows Me/2000/XP

- 1 Click the "Unplug or Eject Hardware" icon  in the system tray.
- 2 Click the message that is displayed.
- 3 When a message is displayed saying that the hardware can be ejected safely, click "OK".

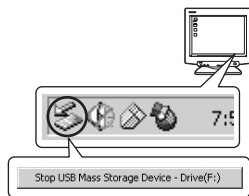

Macintosh

- 1 The trash icon changes to the eject icon when the "Untitled" or "NO_NAME" icon on the desktop is dragged. Drag and drop it on the eject icon.



3 Disconnect the USB cable from the camera.

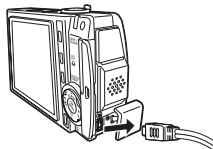

! Note

- Windows Me/2000/XP: When you click “Unplug or Eject Hardware”, a warning message may be displayed. Make sure that image data is not being downloaded from the camera and that all applications are closed. Click the “Unplug or Eject Hardware” icon again and disconnect the cable.

Viewing still pictures and movies

1 Click “Browse Images” on the OLYMPUS Master main menu.

- The “Browse” window is displayed.

2 Double-click the still picture thumbnail that you want to view.

Thumbnail

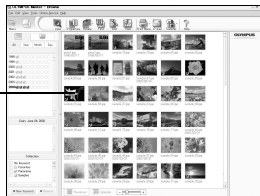

- View mode is enabled and the picture is enlarged.
- To return to the main menu, click “Menu” in the “Browse” window.

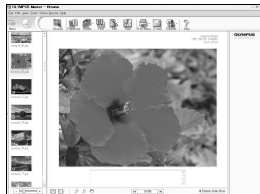

● To view a movie

1 Double-click the movie thumbnail that you want to see in the “Browse” window.

- View mode is enabled and the first frame of the movie is displayed.

2 To play back the movie, click playback button  at the bottom of the screen.

The names and functions of the controller parts are shown below.



	Item	Description
1	Playback slider	Move the slider to select a frame.
2	Time display	Displays the time that has elapsed during playback.
3	Playback (pause) button	Plays the movie. Functions as the pause button during playback.
4	Back button	Displays the previous frame.
5	Forward button	Displays the next frame.
6	Stop button	Stops playback and returns to the first frame.
7	Repeat button	Plays the movie repeatedly.
8	Volume button	Displays the volume adjustment slider.

Printing pictures

Pictures can be printed from the photo, index, postcard and calendar menus. The explanation below uses the photo menu.

1 Click “Print Images at Home”  on the OLYMPUS Master main menu.

- The print menu is displayed.

2 Click “Photo” .

- The “Photo Print” window is displayed.

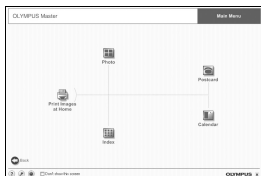

3 Click “Settings” in the “Photo Print” window.

- The printer settings screen is displayed. Make the necessary printer settings.

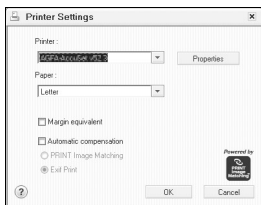

4 Select a layout and size.

- To print the date and time with your image, check the box next to “Print Date”, and select between “Date” and “Date & Time”.

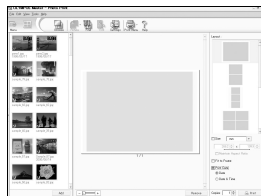

5 Select the thumbnail image that you want to print and click “Add”.

- A preview of the selected image is displayed on the layout.

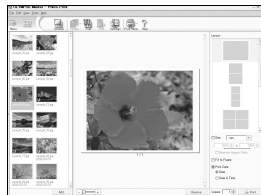

6 Select the number of copies.

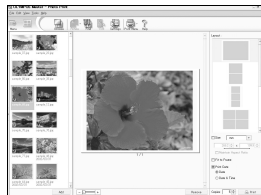

7 Click "Print".

- Printing starts.
- To return to the main menu, click "Menu" in the "Photo Print" window.

To download and save images to a computer without using OLYMPUS Master

This camera is compatible with USB mass storage. You can connect the camera to your computer using the USB cable provided with the camera to download and save images without using OLYMPUS Master. The following environment is required to use the USB cable to connect the camera to your computer.

Windows: Windows 98SE/Me/2000 Professional/XP

Macintosh: Mac OS 9.0 to 9.2/X

Note

- If your computer is running Windows 98SE, you will need to install the USB driver. Before connecting the camera to your computer with the USB cable, double-click the files from the following folders on the provided OLYMPUS Master CD-ROM.
(Drive name):\USB\INSTALL.EXE
- Data transfer is not guaranteed in the following environments, even if your computer is equipped with a USB port.
 - Windows 95/98/NT 4.0
 - Windows 98SE upgrades from Windows 95/98
 - Mac OS 8.6 or earlier
 - Computers with a USB port added by means of an extension card, etc.
 - Computers without a factory-installed OS and home-built computers.

Appendix





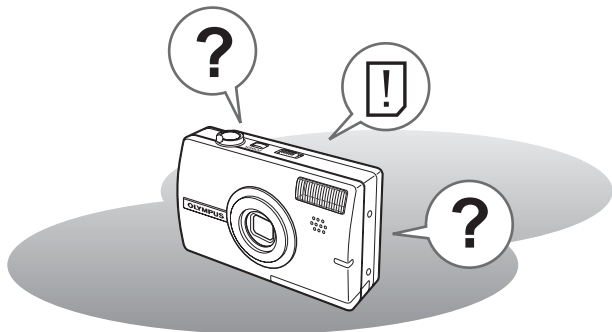



This chapter contains useful information from OLYMPUS.





- When you get an error message while using the camera...
- When you press the **POWER** button but nothing happens...
- When you want to know how to safely store your camera...
- When you don't understand a term used in the manual... Here is where you'll find the answer.

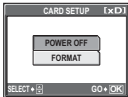

Troubleshooting

Error messages

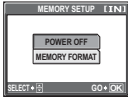
Monitor indication	Possible cause	Corrective action
 CARD ERROR	There is a problem with the card.	This card cannot be used. Insert a new card.
 WRITE-PROTECT	Writing to the card is prohibited.	The recorded image has been protected (read-only) on a computer. Download the image to a computer and cancel the read-only setting.
 MEMORY FULL	The internal memory has no available memory and cannot store any new data.	Insert a card to back up all data or erase unwanted data. Before erasing, download important pictures to a computer.
 CARD FULL	The card has no available memory and cannot store any new data.	Replace the card or erase unwanted data. Before erasing, download important pictures to a computer.
 NO PICTURE	There are no pictures in the internal memory or on the card.	The internal memory or the card contains no pictures. Record pictures.
 PICTURE ERROR	There is a problem with the selected picture and it cannot be played back on this camera.	Use image processing software to view the picture on a computer. If that cannot be done, the image file is damaged.
 CARD-COVER OPEN	The battery compartment/card cover is open.	Close the battery compartment/card cover.
 BATTERY EMPTY	The battery is empty.	Charge or change the battery.





Monitor indication	Possible cause	Corrective action
	<p>When the camera is used for the first time or the battery has been removed for a long time, the date and time are on the factory default setting.</p>	<p>Set the date and time.</p>
	<p>This card cannot be used in this camera. Or, the card is not formatted.</p>	<p>Format the card or replace the card.</p> <ul style="list-style-type: none"> • Select [POWER OFF], and press . Insert a new card. • Select [FORMAT] and press . All data on the card is erased.
	<p>There is an error in the internal memory.</p>	<p>Select [MEMORY FORMAT], and press . All data in the internal memory is erased.</p>

Troubleshooting

● Preparatory operations

Possible cause	Corrective action	Ref. page
The camera does not turn on or function buttons do not respond.		
The power is off.	Press the POWER button to turn the camera on.	P. 9
The battery power is exhausted.	Charge or change the battery.	–
The battery is temporarily unable to function because of the cold.	Warm the battery by putting it in your pocket for a while.	–
The camera is in the sleep mode.	Press the shutter button or turn the zoom lever.	–
The camera is connected to a computer.	The camera will not operate while it is connected to a computer.	P. 141

● Taking pictures

Possible cause	Corrective action	Ref. page
No picture is taken when the shutter button is pressed.		
The battery power is exhausted.	Charge or change the battery.	–
The camera is in the playback mode.	Set the mode switch to the  or  position to enable a shooting mode.	P. 9
The flash has not finished charging.	Remove your finger from the shutter button, and wait until the  (flash charge) mark stops blinking before taking the picture.	P. 44
The power is off.	Set the mode switch to  or  , and press POWER .	P. 10
The internal memory or card is full.	Insert a new card or erase unwanted pictures. Before erasing, download important pictures to a computer.	P. 93, 140
The battery ran out of power during shooting or while the images were being written to the internal memory or the card.	Charge the battery. (Wait until the power/ card access lamp turns off when blinking.)	–
The memory gauge is full.	Wait until there is space in the memory gauge.	–
There is a problem with the card.	See “Error messages”.	P. 147

Possible cause	Corrective action	Ref. page
The monitor is hard to see.		
There is condensation* inside the camera.	Turn the camera off. Before turning it on again, wait until the camera adjusts to the surrounding temperature and dries out.	–
The brightness of the monitor is not adjusted properly.	Use [!☀] to adjust the brightness.	P. 107
The monitor is exposed to direct sunlight.	Block the sunlight with your hand.	–
Vertical lines appear on the monitor screen during shooting.	Aiming the camera at a bright subject in sunlight may cause vertical lines to appear on the screen. This is not a malfunction.	–
The date recorded with the image data is wrong.		
The date and time is not set.	Set the date and time. The clock is not preset.	P. 107
The camera has been left without the battery.	If the camera is left for 1 day without a battery, the date and time setting is canceled. Set the date and time again.	P. 107
The picture is out of focus.		
The subject was too close.	Move further away from the subject. To take pictures closer than 10 cm (4") with the zoom in the maximum wide position, use the super macro mode.	P. 42
Auto focus is not possible.	Use the focus lock to focus on the subject.	P. 24
There is condensation* inside the camera.	Turn the camera off. Before turning it on again, wait until the camera adjusts to the surrounding temperature and dries out.	–
The monitor goes off.		
The camera is in the sleep mode.	Press the shutter button or turn the zoom lever.	–



Possible cause	Corrective action	Ref. page
The flash does not fire.		
The flash is set to [⊕].	Select a flash mode other than [⊕].	P. 43
The subject is illuminated.	If you want the flash to fire on a brightly illuminated subject, set the flash to [⚡].	P. 43
Multi-shot mode is set	The flash does not fire in the multi-shot mode. Set [□] or [📷].	P. 55
The camera is recording a movie.	The flash does not fire in the movie mode. Select a shooting mode other than [🎥].	P. 46
Super macro mode is set.	The flash does not fire in the super macro mode. Set macro mode to [🌸 OFF] or [🌸].	P. 42
Panorama mode is set.	The flash does not fire in the panorama mode. Cancel panorama mode.	P. 57
The battery run time is brief.		
You are using the camera in a cold environment.	Battery performance deteriorates in low temperatures. Keep the camera warm by putting it inside your coat or clothing.	–
The remaining battery power is not indicated correctly.	When battery consumption fluctuates considerably, the camera may turn off without displaying the battery warning indicator. Charge the battery.	–
Label shot does not work		
There is insufficient space on the internal memory	Erase any pictures you do not need. Before erasing, download important data to a computer.	P. 93, P. 140
There are too many labels in the camera	Use OLYMPUS Master to erase unneeded labels. For details, refer to the OLYMPUS Master software help or manual.	–
Compare and shoot is set, but the pictures on the left do not change		
Turn [COMPARE & SHOOT] [ON] then select a picture in the playback mode and then return to the shooting mode.	Press the QUICK VIEW button to go to the playback mode, then do not do anything except press the QUICK VIEW button to return to the shooting mode.	–

* Condensation: When it is cold outside, the water vapor in the air is rapidly cooled and turns to droplets of water. Condensation occurs when the camera is suddenly taken from a cold place into a warm room.

● Playback of recorded images

Possible cause	Corrective action	Ref. page
The pictures in the internal memory cannot be played back.		
The card is inserted in the camera.	When a card is inserted, only pictures on the card can be played back. Remove the card.	P. 30
The picture is out of focus.		
A subject unsuited to AF was taken.	Use the focus lock to focus on the subject.	P. 24
The camera moved when the shutter button was pressed.	Hold the camera correctly and press the shutter button gently. You can stabilize the image by setting [REDUCING BLUR] in SCENE. Camera movement occurs easily with slower shutter speeds. When you take a picture with [Ⓢ] in a night scene or a dark situation, use a tripod, or hold the camera firmly.	—
The lens was dirty.	Clean the lens. Use a commercially available blower brush and then wipe with a lens cleaner to remove dust. Mold may form on the lens surface if the lens is left dirty.	P. 156
The picture is too bright.		
The flash was set to [⚡].	Select a flash mode other than [⚡].	P. 43
The center of the subject is too dark.	If the center of the subject is too dark, the surrounding area emerges as too bright. Adjust the exposure compensation toward minus (-).	P. 52
The [ISO] is at a high setting.	Set [ISO] to [AUTO] or a low sensitivity such as [64].	P. 51

Possible cause	Corrective action	Ref. page
The picture is too dark.		
The flash was blocked by your finger.	Hold the camera correctly, keeping your fingers away from the flash.	–
The subject was out of the working range of the flash.	Shoot within the flash working range.	P. 43
The flash was set to [⚡].	Select a flash mode other than [⚡].	P. 43
The subject was too small and was backlit.	Set the flash to [⚡], or set [METERING] to [●].	P. 43, 54
The sequential shooting mode was used.	Higher shutter speeds are used during sequential shooting, which may result in pictures that are darker than usual. Set [DRIVE] to [□].	P. 55
The center of the subject is too bright.	If the center of the subject is too bright, the image as a whole emerges darker. Adjust the exposure compensation toward plus (+).	P. 52
The colors of pictures look unnatural.		
Indoor lighting affected the picture's colors.	Set the white balance according to the lighting.	P. 53
No white in the picture.	Include something white in the picture, or shoot using [⚡].	P. 43
The white balance setting is wrong.	Adjust the white balance according to the light source.	P. 53
Part of the picture is dark.		
The lens was partly blocked by your finger or the strap.	Hold the camera correctly, keeping your fingers and the strap away from the lens.	–

Possible cause	Corrective action	Ref. page
Pictures you have taken do not appear on the monitor.		
The power is off.	Move the mode switch to the  position and then press the POWER button.	P. 11
The camera is in the shooting mode.	Press the QUICK VIEW button or set the mode switch to  and switch to playback mode.	P. 9
There are no pictures in the internal memory or on the card.	[NO PICTURE] is displayed on the monitor. Record pictures.	–
There is a problem with the card.	See “Error messages”.	P. 147
The camera is connected to a TV.	The monitor does not function when the AV cable is connected to the camera.	P. 89
Single-frame erase, erase selected and all-frame erase cannot be performed.		
The pictures are protected.	Cancel the protection of the pictures.	P. 91
No picture is displayed on the TV when connected to the camera.		
The video output signal is incorrect.	Set the video output signal according to the region where used.	P. 90
The TV video signal setting is incorrect.	Set the TV to the video input mode.	–
The monitor is hard to see.		
The brightness of the monitor is not adjusted properly.	Use  to adjust monitor brightness.	P. 107
The monitor is exposed to direct sunlight.	Block the sunlight with your hand.	–
FRAME/LABLE do not work		
There are no frame or titles for combining in the camera	Use OLYMPUS Master to erase unneeded frames or labels. For details, refer to the OLYMPUS Master software help or manual.	–

● When the camera is connected to a computer or printer

Possible cause	Corrective action	Ref. page
The printer fails to connect.		
[PC] was selected on the monitor after connecting the camera to the printer with the USB cable.	Remove the USB cable, and start again from Step 1 of "Printing pictures".	P. 116, 118
The printer does not support PictBridge.	Refer to the instruction manual for your printer. Or, contact your printer manufacturer.	—
The camera is not recognized by the computer.		
The computer failed to recognize the camera.	Disconnect the USB cable from the camera, and connect it again.	P. 137
The USB driver has not been installed.	Install OLYMPUS Master.	P. 133

Camera care

● Cleaning the camera

Exterior:

- Wipe gently with a soft cloth. If the camera is very dirty, soak the cloth in mild soapy water and wring well. Wipe the camera with the damp cloth and then dry it with a dry cloth. If you have used the camera at the beach, use a cloth soaked in clean water and wrung well.

Monitor:

- Wipe gently with a soft cloth.

Lens:

- Blow dust off the lens with a commercial blower, then wipe gently with a lens cleaner.

Battery/AC adapter:

- Wipe gently with a soft, dry cloth.

! Note

- Do not use strong solvents such as benzene or alcohol, or chemically treated cloth.
- Mold may form on the lens surface if the lens is left dirty.

● Storage

- When storing the camera for extended periods, remove the battery, AC adapter and card, and keep in a cool, dry place that is well ventilated.
- Periodically insert the battery and test the camera functions.

! Note

- Avoid leaving the camera in places where chemical products are handled since this may result in corrosion.

Battery

- This camera uses one Olympus LI-40B lithium ion battery. No other type of batteries can be used.
- Power consumption by the camera varies depending on which functions are used.
- During the conditions described below, power is consumed continuously and the battery becomes exhausted quickly.
 - The zoom is used repeatedly.
 - The shutter button is pressed halfway repeatedly in shooting mode, activating the auto focus.
 - Set [FULLTIME AF] to [ON].
 - A picture is displayed on the monitor for an extended period of time.
 - The camera is connected to a computer or printer.
- Using an exhausted battery may cause the camera to turn off without displaying the battery level warning.
- The rechargeable battery is not fully charged at the time of purchase. Charge the battery fully by connecting the camera to the AC adapter (S-D-1AC) before use (The AC adapter D-7AC, sold separately, can also be used.).
- The provided rechargeable battery usually takes approximately 120 minutes to charge.
- Never use any charger other than the AC adapter.

AC adapter

Use the Olympus AC adapter (S-D-1AC), provided with your camera, to power your digital camera from a common AC wall outlet (The AC adapter D-7AC, sold separately, can also be used.).

An AC adapter is useful for time-consuming tasks such as image downloads to a computer. Do not use any other AC adapter with this camera.

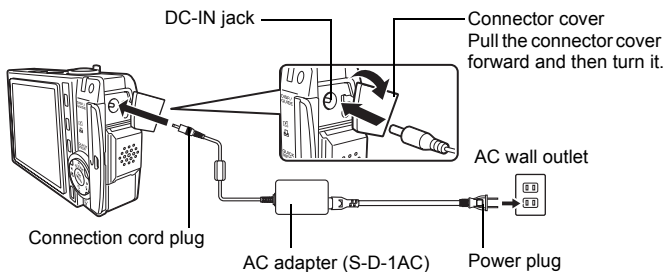

? TIPS

- If you use the AC adapter when there are batteries in the camera, the battery in the camera will be charged. The power/card access lamp slowly blinks red during recharging.

! Note

- If the battery power runs out while the camera is connected to a computer or printer, the image data may be lost or damaged. It is recommended that you use the AC adapter. Do not connect or disconnect the AC adapter while the camera is connected to a computer or printer.
- Do not remove or load the battery or connect or disconnect the AC adapter while the camera is turned on. Doing so could affect the camera's internal settings or functions.
- The AC adapter can be used within the range of AC 100 V to AC 240 V (50/60 Hz).
When using abroad, you may need a plug adapter to convert the plug to match the AC wall outlet. For details, ask at your local electrical shop or travel agent.
- Do not use travel voltage converters as they could damage your AC adapter.
- If an error occurs while the battery in the camera is charging, the power/card access lamp randomly blinks red. Check that the battery and plug are inserted correctly.

Safety Precautions

Caution for Usage Environment

- To protect the high-precision technology contained in this product, never leave the camera in the places listed below, no matter if in use or storage:
 - Places where temperatures and/or humidity are high or go through extreme changes. Direct sunlight, beaches, locked cars, or near other heat sources (stove, radiator, etc.) or humidifiers.
 - In sandy or dusty environments.
 - Near flammable items or explosives.
 - In wet places, such as bathrooms or in the rain. When using products with weatherproof designs, read their manuals as well.
 - In places prone to strong vibrations.
- Never drop the camera or subject it to severe shocks or vibrations.
- When mounted on a tripod, adjust the position of the camera with the tripod head. Do not twist the camera.
- Do not touch electric contacts on cameras.
- Do not leave the camera pointed directly at the sun. This may cause lens or shutter curtain damage, color failure, ghosting on the CCD, or may possibly cause fires.
- Do not push or pull severely on the lens.
- Before storing the camera for a long period, remove the battery. Select a cool, dry location for storage to prevent condensation or mold from forming inside the camera. After storage, test the camera by turning it on and pressing the shutter release button to make sure that it is operating normally.
- Always observe the operating environment restrictions described in the camera's manual.

Battery Handling Precautions

- This camera uses a lithium ion battery specified by Olympus. Do not use any other type of battery. For safe and proper use, read the battery's instruction manual carefully before using it.
- If the battery's terminals get wet or greasy, camera contact failure may result. Wipe the battery well with a dry cloth before use.
- Always charge a battery when using it for the first time, or if it has not been used for a long period.
- When operating the camera with battery power at low temperatures, try to keep the camera and spare battery as warm as possible. A battery that has run down at low temperatures may be restored after it is warmed at room temperature.
- The number of pictures you can take may vary depending on the shooting conditions or battery.
- Before going on a long trip, and especially before traveling abroad, purchase extra batteries. A recommended battery may be difficult to obtain while traveling.
- Please recycle batteries to help save our planet's resources. When you throw away dead batteries, be sure to cover their terminals and always observe local laws and regulations.

LCD Monitor

- Do not push the monitor forcibly; otherwise the image may become vague, resulting in a playback mode failure or damage to the monitor.
- A strip of light may appear on the top/bottom of the monitor, but this is not a malfunction.
- When a subject is viewed diagonally in the camera, the edges may appear zigzagged on the monitor. This is not a malfunction; it will be less noticeable in playback mode.
- In places subject to low temperatures, the LCD monitor may take a long time to turn on or its color may change temporarily. When using the camera in extremely cold places, it is a good idea to occasionally place it in a warm place. An LCD monitor exhibiting poor performance due to low temperatures will recover in normal temperatures.
- The LCD used for the monitor is made with high-precision technology. However, black spots or bright spots of light may appear constantly on the LCD Monitor. Due to its characteristics or the angle at which you are viewing the monitor, the spot may not be uniform in color and brightness. This is not a malfunction.

Legal and Other Notices

- Olympus makes no representations or warranties regarding any damages, or benefit expected by using this unit lawfully, or any request from a third person, which are caused by the inappropriate use of this product.
- Olympus makes no representations or warranties regarding any damages or any benefit expected by using this unit lawfully which are caused by erasing picture data.

Disclaimer of Warranty

- Olympus makes no representations or warranties, either expressed or implied, by or concerning any content of these written materials or software, and in no event shall be liable for any implied warranty of merchantability or fitness for any particular purpose or for any consequential, incidental or indirect damages (including but not limited to damages for loss of business profits, business interruption and loss of business information) arising from the use or inability to use these written materials or software or equipment. Some countries do not allow the exclusion or limitation of liability for consequential or incidental damages, so the above limitations may not apply to you.
- Olympus reserves all rights to this manual.

Warning

Unauthorized photographing or use of copyrighted material may violate applicable copyright laws. Olympus assumes no responsibility for unauthorized photographing, use or other acts that infringe upon the rights of copyright owners.

Copyright Notice

All rights reserved. No part of these written materials or this software may be reproduced or used in any form or by any means, electronic or mechanical, including photocopying and recording or the use of any type of information storage and retrieval system, without the prior written permission of Olympus. No liability is assumed with respect to the use of the information contained in these written materials or software, or for damages resulting from the use of the information contained therein. Olympus reserves the right to alter the features and contents of this publication or software without obligation or advance notice.

FCC Notice

- **Radio and Television Interference**

Changes or modifications not expressly approved by the manufacturer may void the user's authority to operate this equipment. This equipment has been tested and found to comply with the limits for a Class B digital device, pursuant to Part 15 of the FCC Rules. These limits are designed to provide reasonable protection against harmful interference in a residential installation.

This equipment generates, uses, and can radiate radio frequency energy and, if not installed and used in accordance with the instructions, may cause harmful interference to radio communications.

However, there is no guarantee that interference will not occur in a particular installation. If this equipment does cause harmful interference to radio or television reception, which can be determined by turning the equipment off and on, the user is encouraged to try to correct the interference by one or more of the following measures:

- Adjust or relocate the receiving antenna.
- Increase the distance between the camera and receiver.
- Connect the equipment to an outlet on a circuit different from that to which the receiver is connected.
- Consult your dealer or an experienced radio/TV technician for help. Only the OLYMPUS-supplied USB cable should be used to connect the camera to USB enabled personal computers (PC).

Any unauthorized changes or modifications to this equipment would void the user's authority to operate.

Glossary of terms

CCD (Charge-Coupled Device)

This converts light passing through the lens into electrical signals. On this camera, light is picked up and converted into RGB signals to build a single image.

Contrast Detection Method

This is used to measure the distance to the subject. The camera determines if the image is focused by the level of contrast in the subject.

DCF (Design Rule for Camera File System)

A standard for image files by the Japan Electronics and Information Technology Industries Association (JEITA).

DPOF (Digital Print Order Format)

This is for saving desired print settings on digital cameras. By entering which images to print and the number of copies of each, the user can easily have the desired images printed by a printer or print lab that supports the DPOF format.

Eclipsing (Vignetting)

This refers to when an object obscures part of the field of view so that the whole subject is not photographed. Vignetting also refers to when the image seen through the viewfinder does not exactly match the image shot through the objective lens, so the photographed image includes objects not seen through the viewfinder. In addition, vignetting can occur when an incorrect lens hood is used, causing shadowing to appear in the corners of the image.

EV (Exposure Value)

A system for measuring exposure. EV0 is when the aperture is at F1 and the shutter speed is 1 second. The EV then increases by 1 each time the aperture increases by one F stop or the shutter speed increases by one increment. EV can also be used to indicate brightness and ISO.

Exposure

The amount of light used to capture an image. The exposure is determined by the time the shutter is open (shutter speed) and the amount of light that passes through the lens (aperture).

Image Size

The size of an image expressed by the number of pixels that make up the image. For instance, a picture taken with an image size of 640 × 480 fills the computer screen when the monitor setting is 640 × 480. However, if the monitor setting is 1,024 × 768, the picture only takes up part of the screen.

ISO

A method for indicating film speed by the International Organization for Standardization (ISO) (ex. "ISO100"). Higher ISO values indicate greater sensitivity to light, so images can be exposed even in low-light conditions.

JPEG (Joint Photographic Experts Group)

A compression format for still images. Photographs (pictures) taken using this camera are recorded onto the card in JPEG format. By downloading these images to a computer, users can edit them using graphics application software or view the images using an Internet web browser.

Noise reduction

When shooting in dark places, shutter speeds become slower as there is less light focused on the CCD. During long exposures, signals are generated by parts of the CCD where no light is focused and are recorded on the picture as noise. When noise reduction works, the camera automatically reduces the noise to produce clearer images.

NTSC (National Television Systems Committee)/PAL (Phase Alternating Line)

Television formats. NTSC is mainly used in Japan, North America and Korea. PAL is mainly used in Europe and China.

PictBridge

A standard for connecting digital cameras and printers of different makers and printing out pictures directly from a camera.

Pixels

A pixel is the smallest unit (dot) used to make up an image. Clear large-sized printed images require millions of pixels.

Program auto

Also called Program Auto Exposure mode. The camera automatically sets the best shutter speed and aperture for the shot.

Sleep Mode

A mode designed to save battery life. The camera automatically enters the sleep mode if you do not operate it for a certain time. To exit the sleep mode, use any button on the camera (shutter button, arrow pad, etc.).

TFT (Thin-Film Transistor) Color Monitor

A transistor color monitor constructed using thin-film technology.

Miscellaneous



10

This chapter contains all the camera functions described in Chapters 1 to 8.





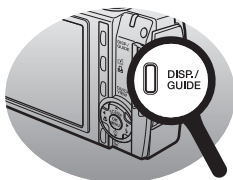







Refer here for lists of the top menus and mode menus.





The index helps you find the pages containing a function or item that you are looking for. For effective use of the manual, reference page numbers are listed in the menu lists.



Menu list

● Shooting mode menus (📷)













Top menu	Tab	Item	Settings	Ref. Page	
MODE MENU	CAMERA	METERING	AUTO, 	P. 54	
		DRIVE	 ,  , MULTI-SHOT	P. 55	
		DIGITAL ZOOM	OFF, ON	P. 41	
		AF MODE	AUTO, SPOT	P. 56	
		PANORAMA		P. 57	
		LABEL SHOT		P. 59	
			OFF, ON	P. 60	
	MEMORY (CARD)	MEMORY FORMAT (FORMAT)	YES, NO	P. 96	
		BACKUP*1	YES, NO	P. 92	
	SETUP	RESET	YES, NO	P. 98	
		  ²		P. 99	
		PW ON SETUP	SCREEN	OFF, 1, 2, 3	P. 100
			SOUND	OFF, 1, 2	
		PW OFF SETUP	SCREEN	OFF, 1, 2	P. 100
			SOUND	OFF, 1, 2	
		REC VIEW	OFF, ON	P. 102	
			OFF, LOW, HIGH	P. 103	
		BEEP	OFF	P. 103	
			1		LOW, HIGH
			2		LOW, HIGH
		SUTTER SOUND	OFF	P. 104	
			1		LOW, HIGH
			2		LOW, HIGH
		FILE NAME	RESET, AUTO	P. 105	
		PIXEL MAPPING		P. 106	
				P. 107	
				P. 107	
		DUAL TIME SETUP	OFF, ON	P. 108	
		VIDEO OUT	NTSC, PAL	P. 90	
		OFF, ON, DIRECT	P. 62		
	FRAME ASSIST	OFF,  , 	P. 63		
	CUSTOM BUTTON		P. 112		
	SLEEP	30SEC, 1MIN, 3MIN, 5MIN, 10MIN	P. 111		

Top menu	Tab	Item	Settings	Ref. Page
COMPARE & SHOOT			OFF, ON	P. 50
MULTI-SHOT			OFF, ON	P. 55
RESET			YES, NO	P. 98
IMAGE QUALITY			<input type="checkbox"/> SH SUPER HIGH6M, <input type="checkbox"/> H1 HIGH 4M, <input type="checkbox"/> H2 HIGH 2M, <input type="checkbox"/> H2 BASIC 1M, <input checked="" type="checkbox"/> E-MAIL VGA	P. 26
WHITE BALANCE			AUTO,  ,  ,  , 	P. 53
EXP. COMP.			-2.0 to +2.0	P. 52
ISO			AUTO, 64, 100, 200, 400	P. 51

*1 Only displayed when a card is being used.

*2 Available languages vary depending on the area where you purchased this camera.

● Shooting mode menus (📷)









Top menu	Tab	Item	Settings	Ref. Page	
MODE MENU	CAMERA	DIGITAL ZOOM	OFF, ON	P. 41	
		FULLTIME AF	OFF, ON	P. 48	
			OFF, ON	P. 48	
	MEMORY (CARD)	MEMORY FORMAT (FORMAT)	YES, NO	P. 96	
		BACKUP*1	YES, NO	P. 92	
	SETUP	RESET	YES, NO	P. 98	
		  *2		P. 99	
		PW ON SETUP	SCREEN	OFF, 1, 2, 3	P. 100
			SOUND	OFF, 1, 2	
		PW OFF SETUP	SCREEN	OFF, 1, 2	P. 100
			SOUND	OFF, 1, 2	
			OFF, LOW, HIGH	P. 103	
		BEEP	OFF	P. 103	
			1		LOW, HIGH
			2		LOW, HIGH
		FILE NAME	RESET, AUTO	P. 105	
		PIXEL MAPPING		P. 106	
				P. 107	
				P. 107	
		DUAL TIME SETUP	OFF, ON	P. 108	
	VIDEO OUT	NTSC, PAL	P. 90		
	CUSTOM BUTTON		P. 113		
	SLEEP	30SEC, 1MIN, 3MIN, 5MIN, 10MIN	P. 111		
	COMPARE & SHOOT			OFF, ON	P. 50
	IMAGE STABILIZER			OFF, ON	P. 47
	RESET			YES, NO	P. 98
	IMAGE QUALITY			 FINE,  STANDARD,  EXTENDED	P. 26
WHITE BALANCE			AUTO,  ,  ,  , 	P. 53	
EXP. COMP.			-2.0 to +2.0	P. 52	



Top menu	Tab	Item	Settings	Ref. Page
		ISO	AUTO, 64, 100, 200, 400	P. 51

*1 Only displayed when a card is being used.

*2 Available languages vary depending on the area where you purchased this camera.

● Playback mode menus (still pictures)

Top menu	Tab	Item	Settings	Ref. Page	
MODE MENU	PLAY		OFF, ON	P. 91	
			+90°, 0°, -90°	P. 66	
				P. 125	
				P. 70	
	MEMORY (CARD)	ALL ERASE	YES, NO	P. 95	
		MEMORY FORMAT (FORMAT)	YES, NO	P. 96	
		BACKUP*1	YES, NO	P. 92	
	SETUP	RESET	YES, NO	P. 98	
		 *2		P. 99	
		PW ON SETUP	SCREEN	OFF, 1, 2, 3	P. 100
			SOUND	OFF, 1, 2	
		PW OFF SETUP	SCREEN	OFF, 1, 2	P. 100
			SOUND	OFF, 1, 2	
		SCREEN SETUP	PW ON SETUP, PW OFF SETUP	P. 101	
		VOLUME	0 to 5	P. 104	
			OFF, LOW, HIGH	P. 103	
		BEEP	OFF	P. 103	
			1		LOW, HIGH
			2		LOW, HIGH
				P. 107	
				P. 107	
		DUAL TIME SETUP	OFF, ON	P. 108	
	VIDEO OUT	NTSC, PAL	P. 90		
SCREENSAVER	OFF, ON	P. 110			
SLEEP	30SEC, 1MIN, 3MIN, 5MIN, 10MIN	P. 111			
COMPOSE IMAGE			FRAME, LABEL, CALENDAR, LAYOUT, CANCEL	P. 80	
ADJUST IMAGE			BRIGHTNESS, SATURATION, COLOR BALANCE, WARM/COOL, CANCEL	P. 84	

Top menu	Tab	Item	Settings	Ref. Page
EDIT IMAGE			  REDEYE FIX, BLACK & WHITE, SEPIA, CANCEL	P. 85
ALBUM			SEL. ALBUM, ALBUM ENTRY, CANCEL	P. 69
SLIDESHOW			SCROOL, FADER, ZOOM, CHECKERBOARD, BLINDS, SWIVEL, POP, HEARTS, CIRCLE, SQUARE1, SQUARE2, RANDOM	P. 76
CALENDAR				P. 66
ERASE			ERASE, ERASE SELECTED, ALL ERASE, CANCEL	P. 93

*1 Only displayed when a card is being used.

*2 Available languages vary depending on the area where you purchased this camera.

● Playback mode menus (🔊)

Top menu	Tab	Item	Settings	Ref. Page	
MODE MENU	PLAY		OFF, ON	P. 91	
	MEMORY (CARD)	ALL ERASE	YES, NO	P. 95	
		MEMORY FORMAT (FORMAT)	YES, NO	P. 96	
		BACKUP*1	YES, NO	P. 92	
	SETUP	RESET	YES, NO	P. 98	
		*2		P. 99	
		PW ON SETUP	SCREEN	OFF, 1, 2, 3	P. 100
			SOUND	OFF, 1, 2	
		PW OFF SETUP	SCREEN	OFF, 1, 2	P. 100
			SOUND	OFF, 1, 2	
		SCREEN SETUP	PW ON SETUP, PW OFF SETUP	P. 101	
		VOLUME	0 to 5	P. 104	
			OFF, LOW, HIGH	P. 103	
		BEEP	OFF	P. 103	
			1		LOW, HIGH
			2		LOW, HIGH
				P. 107	
				P. 107	
		DUAL TIME SETUP	OFF, ON	P. 108	
	VIDEO OUT	NTSC, PAL	P. 90		
	SCREENSAVER	OFF, ON	P. 110		
SLEEP	30SEC, 1MIN, 3MIN, 5MIN, 10MIN	P. 111			
INDEX PLAY			P. 68		
MOVIE PLAY			P. 67		
EDIT			EDIT, INDEX, CANCEL P. 85		
ALBUM			SEL. ALBUM, ALBUM ENTRY, CANCEL P. 69		

Top menu	Tab	Item	Settings	Ref. Page
SLIDESHOW			SCROOL, FADER, ZOOM, CHECKERBOARD, BLINDS, SWIVEL, POP, HEARTS, CIRCLE, SQUARE1, SQUARE2, RANDOM	P. 76
CALENDAR				P. 66
ERASE			ERASE, ERASE SELECTED, ALL ERASE, CANCEL	P. 93

*1 Only displayed when a card is being used.

*2 Available languages vary depending on the area where you purchased this camera.

● Playback mode menus (album playback mode)

Top menu	Item	Settings	Ref. Page
ALBUM MENU	 *1	 , 	P. 125
	VOLUME	0 to 5	P. 104
			P. 107
	VIDEO OUT	NTSC, PAL	P. 90
SEL. ALBUM			P. 72
SELECT TITLE IMAGE		OK, CANCEL	P. 73
UNDO ENTRY		SEL. IMAGE, UNDO ALL, CANCEL	P. 73
CLOSE ALBUM			P. 72
SLIDESHOW		SCROOL, FADER, ZOOM, CHECKERBOARD, BLINDS, SWIVEL, POP, HEARTS, CIRCLE, SQUARE1, SQUARE2, RANDOM	P. 76
ROTATION*1		+90°, 0°, -90°	P. 66
INDEX PLAY*2			P. 68
PROTECT		OFF, ON	P. 91



*1 Not displayed for movies.

*2 Not displayed for still pictures.



List of factory default settings

The functions are set as follows when the camera leaves the factory.





● Shooting modes

SCENE	PROGRAMAUTO
Information display (DISP./GUIDE)	Information on screen
Optical zoom	Wide
 s 	 OFF
	 OFF
Flash	Still pictures: AUTO Movies: Flash off
COMPARE & SHOOT	OFF
IMAGE QUALITY	Still picture:  SUPER HIGH6M Movies:  STANDARD
WHITE BALANCE	AUTO
EXP. COMP.	0.0
ISO	AUTO
IMAGE STABILIZER	OFF
METERING	AUTO
DRIVE	
DIGITAL ZOOM	OFF
AF MODE	AUTO
 (still pictures)	OFF
FULL TIME AF	OFF
 (movies)	OFF
REC VIEW	ON
SHUTTER SOUND	1 - LOW
FILE NAME	RESET
	ON
FRAME ASSIST	
CUSTOM BUTTON	COMPARE & SHOOT

● Playback mode

Information display (DISP./GUIDE)	Information on screen
SLIDESHOW	SCROLL
	OFF
ROTATION	0°
	OFF
VOLUME	3
SCREENSAVER	OFF

● Others











	*
PW ON SETUP	SCREEN: 1 SOUND: 1
PW OFF SETUP	SCREEN: 1 SOUND: 1
	LOW
BEEP	1 - LOW
	±0
	Y-M-D 2005.01.01 00:00
DUAL TIME SETUP	OFF
VIDEO OUT	NTSC or PAL*
SLEEP	3 MIN

* Settings differ according to the region where the camera is sold.

Functions available in shooting modes and scenes













Some functions cannot be set in certain shooting modes and scenes. For more details, refer to the table below.

Function	Still picture (📷)									
	P									
INFO										✓
Optical zoom										✓
										✓
s										✓
										✓
FLASH MODE										✓
COMPARE & SHOOT										✓
IMAGE QUALITY										✓
WHITE BALANCE										✓
EXP. COMP.										✓
ISO										✓*1
IMAGE STABILIZER										—
METERING										✓
DRIVE			✓				—	✓	—	✓
DIGITAL ZOOM										✓
AF MODE										✓
PANORAMA										✓
LABEL SHOT										✓
(still pictures)										✓
FULLTIME AF										—
(movies)										—
MEMORY FORMAT (FORMAT)										✓
BACKUP										✓
RESET										✓
										✓
PW ON SETUP										✓
PW OFF SETUP										✓
REC VIEW										✓
										✓











Function	Shooting mode Scene mode		Still picture (📷)							
	P									
BEEP						✓				
SHUTTER SOUND						✓				
FILE NAME						✓				
PIXEL MAPPING						✓				
						✓				
						✓				
DUALTIME SETUP						✓				
VIDEO OUT						✓				
						✓				
FRAME ASSIST						✓				
CUSTOM BUTTON						✓				
SLEEP						✓				

*1 Auto is fixed during .



Function	Shooting mode		Scene mode		Still picture (📷)																
INFO																					✓
Optical zoom	✓	—																			✓
				✓				—													✓
s	✓	—		✓			—														✓
																					✓
FLASH MODE	—	✓					—										✓				—
COMPARE & SHOOT																					✓
IMAGE QUALITY																					✓
WHITE BALANCE																					✓
EXP. COMP.																					✓
ISO																					✓
IMAGE STABILIZER																					—
METERING																					✓
DRIVE	—	✓					—														✓
DIGITAL ZOOM	✓	—																			✓
AF MODE																					✓
PANORAMA																					✓
LABEL SHOT																					✓
(still pictures)																					✓
FULLTIME AF																					—
(movies)																					—
MEMORY FORMAT (FORMAT)																					✓
BACKUP																					✓
RESET																					✓
																					✓
PW ON SETUP																					✓
PW OFF SETUP																					✓
REC VIEW																					✓
																					✓
BEEP																					✓
SHUTTER SOUND																					✓
FILE NAME																					✓

Function	Shooting mode Scene mode		Still picture (📷)							
										
PIXEL MAPPING					✓					
					✓					
					✓					
DUALTIME SETUP					✓					
VIDEO OUT					✓					
					✓					
FRAME ASSIST					✓					
CUSTOM BUTTON					✓					
SLEEP					✓					

Function	Shooting mode Scene mode		Still picture (📷)							Movie (🎥)
										
INFO						✓				
Optical zoom						✓ ^{*2}				
						✓ ^{*3}				—
s 	—					✓				—
	✓	—						✓		
FLASH MODE	—					✓				—
COMPARE & SHOOT						✓				
IMAGE QUALITY						✓ ^{*4}				
WHITE BALANCE						✓				
EXP. COMP.						✓				
ISO						✓				
IMAGE STABILIZER					—					✓
METERING						✓				—
DRIVE		—						✓		—
DIGITAL ZOOM						✓				
AF MODE						✓				—
PANORAMA	✓	—						✓		—
LABEL SHOT						✓				—
 (still pictures)	✓	—						✓		—
FULLTIME AF						—				✓
 (movies)						—				✓
MEMORY FORMAT (FORMAT)						✓				
BACKUP						✓				
RESET						✓				
						✓				
PW ON SETUP						✓				
PW OFF SETUP						✓				
REC VIEW						✓				—
						✓				
BEEP						✓				
SHUTTER SOUND						✓				—
FILE NAME						✓				

Function	Shooting mode Scene mode		Still picture (📷)							Movie (📹)
										
PIXEL MAPPING					✓					
					✓					
					✓					
DUALTIME SETUP					✓					
VIDEO OUT					✓					
					✓					—
FRAME ASSIST					✓					—
CUSTOM BUTTON					✓					
SLEEP					✓					

*2 Wide angle (W) is fixed during .

*3 Macro () is fixed during .

*4 E-MAIL VGA (640x480) is fixed during .

..... 103
SCENE 35
POWER button 10
 button (custom) 12, 112
 button (erase) 13, 75, 93
 button (flash mode) 12, 43
 button (macro mode) 12, 42
 button (OK/MENU) 12, 13, 14
 button (print) 13, 116
△ SCENE button (SCENE
 SELECT) 12, 38
 button (self-timer) 12, 45
 mode switch (playback) 9, 11
 mode switch (shooting)
 9, 10

A

AC adapter 158
 Adding sound 77
 ADJUST IMAGE 84
 AF MODE 56
 AF target mark 24
 ALBUM 69, 72
 ALBUM ENTRY 70
 ALBUM MENU 69
 Album playback mode 17, 69
 ALL ERASE 95
 ALL INDEX 121
 ALL PRINT 121
 All-frame reservation 128
 Arrow pad 19
 AUCTION 37
 AUTO (AF mode) 56
 AUTO (flash) 43
 AUTO (ISO) 51
 AUTO (white balance) 53
 Auto focus 25
 AV cable 89
 AVAILABLE LIGHT
 PORTRAIT 36

B

BACKUP 92
 BASIC 1M 26, 29
 Battery 157, 159

Battery compartment/card cover
 32
 Beach 37
 BEEP 103
 BEHIND GLASS 37
 BLACK & WHITE 78
 BLINDS 76
 BRIGHTNESS 84

C





























CALENDAR 80
 CALENDAR 66
 Cancel 14
 CANDLE 36
 Card 31
 CCD 106, 163
 CHECKERBOARD 76
 CIRCLE 76
 CLOSE ALBUM 72
 Cloudy day 53
 COLOR BALANCE 84
 Compare & shoot 50
 COMPOSE IMAGE 80
 Connector cover 89
 CUISINE 37
 CUSTOM BUTTON 112
 CUSTOM PRINT 118



D

Date and time 107
 DC-IN jack 158
 DIGITAL ZOOM 41
 DIRECT (Histogram) 62
 Direct printing 115
DISP./GUIDE button
 12, 13, 21, 61
 DOCUMENTS 37
 DPOF 125, 163
 DRIVE 55
 Dual time 108
 DUAL TIME SETUP 108





E

EASY PRINT 116
 EDIT 85, 87

- EDIT IMAGE  78
 E-MAIL VGA  26, 29
 ERASE  93
 ERASE SELECTED 94
 Error messages 124, 147
 EV 163
 Exposure 24, 163
 Exposure compensation  52
- F**
- FADER 76
 FILE NAME 105, 123
 Fill-in flash  43
 FIREWORKS  36
 Flash 43
 Flash charging 45
 Flash mode  44
 Flash off  44
 Flash stand-by 44
 Fluorescent lamp  53
 Focus 24, 56
 Focus lock 24
 FORMAT 96
 FORMAT  96
 FRAME 80
 FRAME ASSIST  63
 FULLTIME AF 48
- G**
- Green lamp 24
- H**
- HEARTS 76
 HIGH 2M  26, 29
 HIGH 4M  26, 29
 Histogram  61, 62
- I**
- Image size 26, 163
 IMAGE STABILIZER  47
 IN 30
 INDEX 86
 INDEX PLAY  68
 INDOOR  36
- Information display **DISP./GUIDE**
 13, 61
 Internal memory 30
 ISO ^{ISO}  51, 163
- J**
- JPEG 26, 163
- L**
- LABEL 80
 LABEL SHOT 59
 LANDSCAPE  35
 LANDSCAPE+PORTRAIT  35
 LAYOUT 80
 Lithium ion battery 157, 159
- M**
- Macro  42
 MEMORY FORMAT 96
 Menu guide 21
 Metering 54
 Metering AUTO 54
 Microphone 77
 MODE MENU  14, 18
 Monitor brightness
 adjustment  107
 Motion-JPEG 27
 MOVIE 67
 MOVIE PLAY  67
 Movie recording  46
 MULTI PRINT 121
 Multi-connector
 89, 116, 118, 137
 MULTI-SHOT  55
 MUSEUM  36
- N**
- NIGHT SCENE  35
 NIGHT+PORTRAIT  36
 Noise reduction 38, 164
 NTSC 90, 164
 Number of prints 125
 Number of storable still pictures
 27

- O**
 OLYMPUS Master 132
 Optical zoom 40
- P**
 PAL 90, 164
 PANORAMA 57
 PC 137
 PictBridge 115, 164
 PIXEL MAPPING 106
 Pixels 27, 164
 Playback mode  9, 11, 65
 Playback on a TV 89
 Playing time 67
 POP 76
 PORTRAIT  35
 Press fully 24
 Press halfway 24
 PRINT ORDER 121
 Print settings  125
 Program auto **P** 35, 164
 Protect **On** 91
 PW OFF SETUP 100
 PW ON SETUP 100
- Q**
 QUICK VIEW button 12, 65
- R**
 RANDOM 76
 REC VIEW 102
 Record mode  26, 29
 Recording sound with
 movies  48
 Recording sound with
 pictures  60
 Red-eye fill-in  43
 REDEYE FIX 78
 Red-eye reduction flash  43
 Reducing Blur  35
 Remaining recording time 27
 RESET  98
 Resizing  78
 ROTATION  66
- S**
 SATURATION 84
 SCREEN SETUP 101
 SCREENSAVER 110
 SCROLL 76
 SEL. ALBUM  72
 SEL. IMAGE 70, 73
 SELECT TITLE IMAGE  73
 Selecting a language  99
 SELF PORTRAIT  36
 Self-timer  12, 45
 Self-timer lamp 45
 SEPIA 78
 Sequential  55
 SET ALL 70
 SET CALENDAR 70
 SHOOT & SELECT 1/2   37
 Shooting mode  9, 10
 Shortcut menus 14, 15
 Shutter button 24
 SHUTTER SOUND 104
 Single  55
 Single-frame erase  75, 93
 Single-frame reservation  127
 SLEEP 111
 Sleep mode 164
 Slideshow  76
 Snow  37
 SPORT  35
 SPOT (AF MODE) 56
 Spot metering  54
 SQUARE 1/2 76
 STANDARD 115
 Sunny day  53
 SUNSET  36
 SUPER HIGH6M **SH** 26, 29
 Super macro  42
 SWIVEL 76
- T**
 Top menu 14
 Total recording time 67
 Trimming 78, 123
 Tungsten light  53

U

UNDER WATER MACRO 	38
UNDER WATER WIDE 1/2	
 1  2	38
UNDO ALL	73
UNDO ENTRY 	73
USB cable	116, 118, 137, 145
USB driver	133, 145
Using memory	30

V

VIDEO OUT	90
VOLUME	104

W

WARM/COOL	84
WHITE BALANCE WB	53

X

xD	30
xD-Picture Card	31

Z

ZOOM	40, 76
ZOOM (Slideshow)	76
Zoom lever	40, 65

OLYMPUS®

<http://www.olympus.com/>

OLYMPUS IMAGING CORP.

Shinjuku Monolith, 3-1 Nishi-Shinjuku 2-chome, Shinjuku-ku, Tokyo, Japan

OLYMPUS IMAGING AMERICA INC.

Two Corporate Center Drive, P.O. Box 9058, Melville, NY 11747-9058, U.S.A. Tel. 631-844-5000

Technical Support (USA)

24/7 online automated help: <http://www.olympusamerica.com/support>

Phone customer support: Tel. 1-888-553-4448 (Toll-free)

Our phone customer support is available from 8 am to 10 pm

(Monday to Friday) ET

E-Mail: distec@olympus.com

Olympus software updates can be obtained at: <http://www.olympus.com/digital>

OLYMPUS IMAGING EUROPA GMBH

Premises: Wendenstrasse 14-18, 20097 Hamburg, Germany

Tel: +49 40-23 77 3-0 / Fax: +49 40-23 07 61

Goods delivery: Bredowstrasse 20, 22113 Hamburg, Germany

Letters: Postfach 10 49 08, 20034 Hamburg, Germany

European Technical Customer Support:

Please visit our homepage <http://www.olympus-europa.com>

or call our TOLL FREE NUMBER* : **00800 - 67 10 83 00**

for Austria, Belgium, Denmark, Finland, France, Germany, Italy, Luxemburg, Netherlands,
Norway, Portugal, Spain, Sweden, Switzerland, United Kingdom

* Please note some (mobile) phone service providers do not permit access or request an
additional prefix to +800 numbers.

For all European Countries not listed and in case that you can't get connected
to the above mentioned number, please make use of the following

CHARGED NUMBERS: **+49 180 5 - 67 10 83** or **+49 40 - 237 73 899**

Our Technical Customer Support is available from 9 am to 6 pm MET (Monday to Friday)