

OLYMPUS[®]

LINEAR PCM RECORDER

LS-P4
LS-P1

Linear PCM Recorder
USER MANUAL

Getting started

1

Recording

2

Playback

3

Menu

4

Bluetooth[®] function

5

Use with a PC

6

Other information

7

Additions/modifications
by firmware update

8

Thank you for purchasing an Olympus digital voice recorder.
Please read these instructions for information about using the product
correctly and safely.

Keep the instructions handy for future reference.

To ensure successful recording, we recommend that you test the record
function and volume before use.



Table of contents

Names of parts	4
Recorder	4
Display	5

1 Getting started

Setup	8
Inserting the battery	9
Turning the power ON	10
Selecting the battery setting	10
Setting the time/date	11
Setting the voice guidance	11
Charging the battery	12
Charging the battery by connecting to a PC's USB connector ...	12
Charging the battery by connecting to an AC adapter with a USB connection (model AS14; optional)	14
Batteries	16
Inserting/removing a microSD card	18
Inserting a microSD card	18
Removing a microSD card	19
Preventing accidental operation	20
Setting HOLD mode	20
Releasing HOLD mode	20
Turning the power OFF	21
[Home] screen operations	22
Selecting the mode	22
Selecting folders and files	23
Attaching the tripod adapter (TR2)	25

2 Recording

Recording	27
Basic recording procedure	27
Pausing/resuming recording	30
Quickly checking a recording	30
Monitoring while recording	31
Selecting the automatic recording setting [Rec Scene]	32
Changing the recording scene	32
Overdubbing	35
Selecting a file for overdubbing	35
Recording with an external microphone	37
Recording from another connected device	38
Recording audio from another device with this recorder	38
Recording audio from this recorder with another device	38

3 Playback

Playback	39
Basic playback procedure	39
Fast-forwarding	40
Rewinding	40
Skipping to the beginning of a file	41
Playback through the earphones	42
Changing the playback speed	44
ABC repeat playback	45
Index marks/temp marks	48
Writing an index mark/temp mark	48
Erasing an index mark/temp mark	49
Erasing all index marks at once	49
Calendar Search function	51
Erasing files/folders	52
Erasing files	52
Erasing a folder	53

4 Menu

Setting menu items	54
Basic operation	54
File menu [File Menu]	57
Extracting the speaking portions of files of spoken-word content [Voice Detect]	57
Preventing accidental file erasure [File Lock]	57
Sorting files [Sort by]	57
Moving/copying files [Move/Copy]	58
Dividing files [File Divide]	58
Partially erasing files [Partial Erase]	58
Trimming a file [Trimming]	58
Increasing the overall volume level of a file [Normalize]	58
Fading in/out audio at the beginning/end of a file [Fade in/out]	59
Displaying file or folder information [Property]	59
Recording menu [Rec Menu]	60
Selecting the recording level [Rec Level]	60
Reducing clipping [Limiter]	61
Setting the recording mode [Rec Mode]	61
Selecting microphone directivity [Zoom Mic]	62
Reducing noise during recording [Low Cut Filter]	63
Selecting the three microphones system [Mic Select]	63
Voice-activated recording function [VCVA]	64
Voice sync recording function [V-Sync Rec]	65

Table of contents

Playback menu [Play Menu]	67
Skipping non-voice portions during playback [Voice Playback]	67
Reducing noise during playback [Noise Cancel]	67
Adjusting low volume portions during playback [Voice Balancer]	68
Selecting playback modes [Play Mode]	68
Changing music sound quality [Equalizer]	69
Setting a skip space [Skip Space]	70
LCD/Sound menu [LCD/Sound Menu]	71
Setting the backlight [Backlight]	71
Adjusting the contrast [Contrast]	71
Setting the LED indicator light [LED]	71
Turning beeping sound on/off [Beep]	71
Changing the display language [Language]	71
Setting the voice guidance [Voice Guide]	72
Playing the beginning of files automatically [Intro Play]	72
Selecting the speaker output [Speaker]	72
Device menu [Device Menu]	73
Selecting the recording media [Memory Select]	73
Setting power save mode [Power Save]	73
Setting the battery in use [Battery]	73
Setting the time/date [Time & Date]	74
Connecting a Bluetooth® device [Bluetooth]	75
Setting the USB connection [USB Settings]	75
Restoring the default settings [Reset Settings]	75
Formatting a recording media [Format]	76
Checking recording media information [Memory Info.]	76
Checking voice recorder information [System Info.]	76
Extracting the speaking portions of files of spoken-word content [Voice Detect]	77
Moving/copying files [Move/Copy]	79
Dividing files [File Divide]	82
Partially erasing files [Partial Erase]	84
Trimming a file [Trimming]	86
Fading in/out audio at the beginning/end of a file [Fade in/out]	88
Setting the voice guidance [Voice Guide]	89
Setting the USB connection [USB Settings]	91
Formatting recording media [Format]	93

5 Bluetooth® function

Before using the Bluetooth® function	95
About OLYMPUS Audio Controller BT	97

Connecting/disconnecting a Bluetooth® device	98
Connecting a Bluetooth® device	98
Disconnecting the connection with a Bluetooth® device	102

6 Use with a PC

PC operating environment	103
PC connection/disconnection	105
Connecting the voice recorder to a PC	105
Disconnecting the voice recorder from a PC	107
Transferring files to a PC	108

7 Other information

Alarm message list	110
Troubleshooting	112
Recorder care	116
Accessories (optional)	117
Copyright and trademark information	118
Safety precautions	120
Specifications	125

Indications used in this manual

NOTE

Describes precautions and operations that should be absolutely avoided in using the voice recorder.

TIP

Describes useful information and hints that will help you getting the most out of your voice recorder.



Indicates reference pages describing details or related information.

Names of parts

Recorder

Names of parts

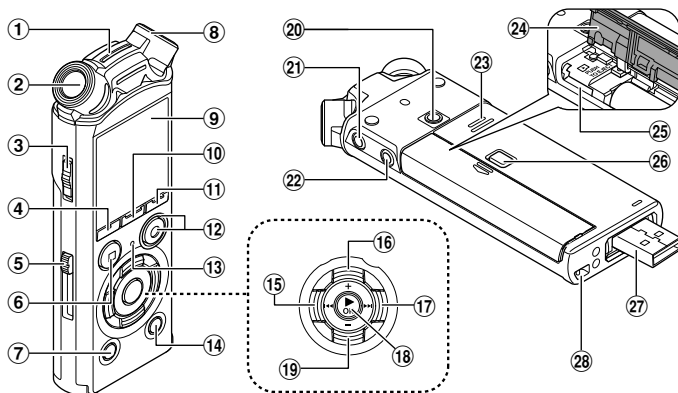

- ① Built-in center microphone*
- ② Built-in stereo microphone (L)
- ③ **POWER/HOLD** switch
- ④ **F1** button
- ⑤ **USB** connector slide lever
- ⑥ **STOP** (■) button
- ⑦ **ERASE** button
- ⑧ Built-in stereo microphone (R)
- ⑨ **Display**
- ⑩ **MENU/SCENE** button
- ⑪ **F2** button
- ⑫ **REC** (record)(●) button, Recording indicator light (LED)
- ⑬ **PEAK** indicator light (LED), LED indicator light (LED)
- ⑭ **LIST** button
- ⑮ **◀◀** button
- ⑯ **+** button
- ⑰ **▶▶** button
- ⑱ **▶** **OK** button
- ⑲ **-** button
- ⑳ **Attachment** mounting hole
- ㉑ **Earphone** jack (🎧)
- ㉒ **Microphone** jack (🎤)
- ㉓ **Built-in** speaker
- ㉔ **Battery/card** cover
- ㉕ **microSD** card slot
- ㉖ **Battery/card** cover lock button
- ㉗ **USB** connector/USB connector cover (retractable)
- ㉘ **Strap** hole

* LS-P4 model only

Names of parts

Display

■ [Recorder] mode

Folder list display

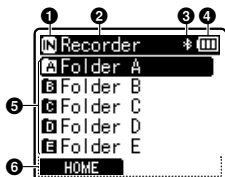

File list display

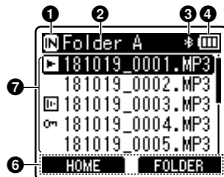

File display

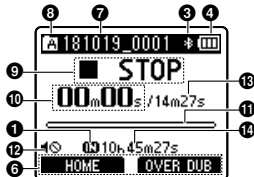

Names of parts

1 Recording media indicator

[N]: Internal memory

[μ]: microSD card

2 Current folder name

3 Bluetooth® indicator*

4 Battery indicator

5 Folder name

6 Function button guide display

7 File name

[▶]: Playback indicator

[V]: Voice Detect indicator

[L]: File lock indicator

8 Folder indicator

9 Voice recorder status indicator

[○]: Recording indicator

[⊞]: Recording pause indicator

[■]: Stop indicator

[▶]: Playback indicator

[▶]: Fast playback indicator

[▶]: Slow playback indicator

[▶]: Fast-forward indicator

[◀]: Fast-rewind indicator

10 Elapsed recording time (during recording mode), playback time (during playback mode)

11 Level meter (during recording mode), playback position bar indicator (during playback mode)

12 Speaker muting indicator (M)

13 File length

14 Possible recording time remaining

* LS-P4 model only

Names of parts

Display

■ [Music] mode

List display ①

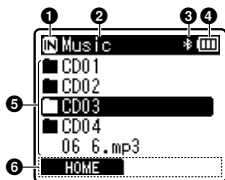

When folder contains files and folders

List display ②

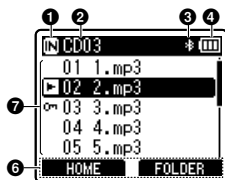

When folder contains only files

File display

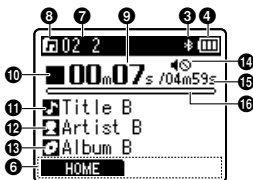

① Recording media indicator

- [M]: Internal memory
- [C]: microSD card

② Current folder name

③ Bluetooth® indicator*

④ Battery indicator

⑤ Folder name or file name

⑥ Function button guide display

⑦ File name

- [▶]: Playback indicator
- [🔒]: File lock indicator

⑧ Folder indicator

⑨ Elapsed playback time

⑩ Voice recorder status indicator

- [■]: Stop indicator
- [▶]: Playback indicator
- [▶▶]: Fast playback indicator
- [▶▶▶]: Slow playback indicator
- [▶▶▶▶]: Fast-forward indicator
- [◀◀]: Fast-rewind indicator

⑪ Music title

⑫ Artist name

⑬ Album name

⑭ Speaker muting indicator (M)

⑮ File length

⑯ Playback position bar indicator

* LS-P4 model only

Display

TIP

- Pressing and holding the **STOP** (■) button while the voice recorder is in stop mode displays the settings **[Time & Date]** and **[Remain]** (amount of possible recording time remaining). If the current time/date is set incorrectly, see “**Setting the time/date [Time & Date]**” (P.74).

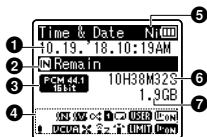

- 1** Current time & date
- 2** Recording media indicator
- 3** Recording format indicator
- 4** Indicator display area

[**CONE**]: Rec Scene
[**NC**]: Noise Cancel
[**VB**]: Voice Balancer
[**R**]: Random
[**1**]: Playback Range
[**REP**]: Repeat

[**USER**]: Equalizer
[**ON**]: Voice Playback
[**M**]: Rec Level
[**VCVA**]: VCVA
[**SYNC**]: V-Sync. Rec
[**LCF**]: Low Cut Filter
[**ZM**]: Zoom Mic
[**MS**]: Mic Select*
[**LIMIT**]: Limiter
[**ON**]: Voice Detect

- 5** Battery indicator
- 6** Possible recording time
- 7** Available free space

* LS-P4 model only

Getting started

Setup

1

Setup

After unpacking the voice recorder, follow the steps below to have it ready for use.

Getting started **1**

Inserting the battery

Getting started **2**

Turning the power ON

Getting started **3**

Selecting the battery setting

Select the battery setting to match the inserted battery. Select the setting for a nickel-metal hydride rechargeable battery or the setting for an alkaline battery.

Getting started **4**

Setting the time/date

Set the voice recorder's clock for use with file management.

Getting started **5**

Setting the voice guidance*

*LS-P4 model only

Inserting the battery

Before using the voice recorder, insert the battery in the battery compartment of the voice recorder.

- 1 Press and hold the battery/card cover lock button, and then slide the battery/card cover to open.**

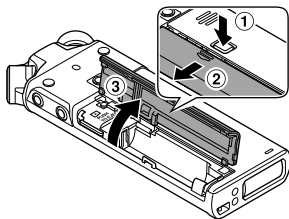

- 3 Slide the battery/card cover completely closed.**

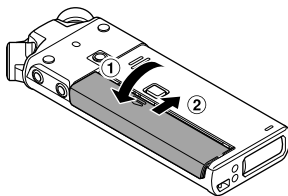

- 2 Insert a AAA battery, making sure its positive and negative terminals are placed correctly.**

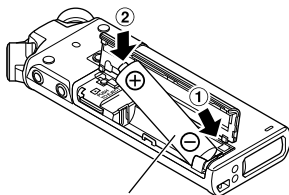

Insert the battery's negative terminal first

Turning the power ON

- 1 While the voice recorder is turned off, slide the **POWER/HOLD** switch in the direction of the arrow.

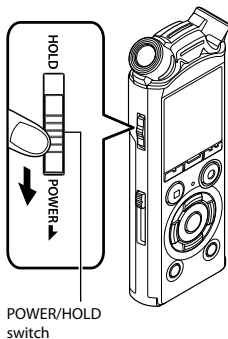

Selecting the battery setting

- 1 Press the **+** or **-** button to select the type of battery you inserted.

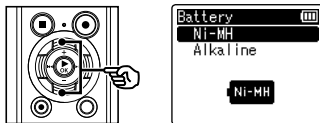

[Ni-MH]

Select if you inserted an Olympus nickel-metal hydride rechargeable battery (model BR404).

[Alkaline]

Select if you inserted an alkaline battery.

- 2 Press the **▶ OK** button to finalize the setting.

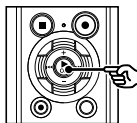

NOTE

- See “**Setting the time/date**” if a time display with a blinking cursor on the hour appears in the display after setting the battery (P.11).

Setting the time/date

- 1 Press the **▶▶▶** or **◀◀◀** button to select the item to set.

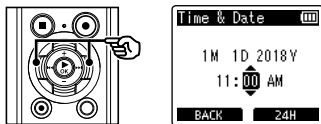

- 2 Press the **+** or **-** button to change the number.

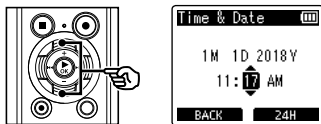

- To change the setting of another item, press the **▶▶▶** or **◀◀◀** button to move the blinking cursor, then press the **+** or **-** button to change the number.

- 3 Press the **▶OK** button to finalize the setting.

TIP

- You can press the **▶OK** button during the setting procedure to set the items entered so far and start the clock.
- You can change the clock display format. See **"Setting the time/date [Time & Date]"** (P.74) for the procedure.

Setting the voice guidance

Using this feature, a voice announces the operating conditions of the recorder.

! LS-P4 model only

- 1 Press the **+** or **-** button to select **[On]** or **[Off]**.

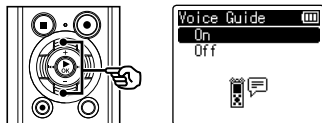

[On]

Voice guidance will be enabled.

[Off]

Voice guidance will be canceled.

- 2 Press the **▶OK** button to finalize the setting.

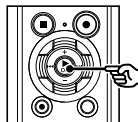

TIP

- **[On/Off]**, **[Speed]**, and **[Volume]** can be set for the voice guidance. See **"Setting the voice guidance [Voice Guide]"** (P.89) for the procedure.

Charging the battery

Charging the battery by connecting to a PC's USB connector

NOTE

- Before charging the battery, insert the rechargeable battery provided and set **[Battery]** to **[Ni-MH]** (P.9, P.10).
- Never attempt to charge an alkaline battery, lithium battery or other primary cell battery. Fluid leakage or overheating may cause the recorder to malfunction.

1 Start the PC.

2 Slide the USB connector slide lever in the direction of the arrow.

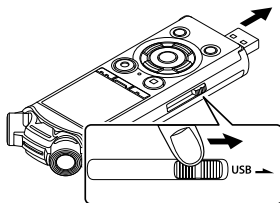

- The USB connector extends out. The USB connector cover is stored inside the voice recorder.

3 After making sure the voice recorder is stopped, connect the USB connector to a USB port on a PC.

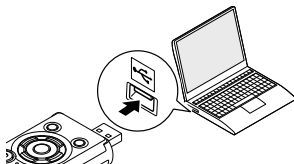

4 Press the ►OK button to start charging the battery.

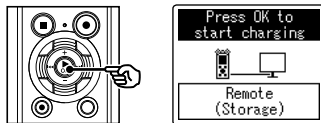

- When **[Battery]** (P.73) is set to **[Ni-MH]**, **[Press OK to start charging]** appears on the display. Press the ►OK button while this message is blinking.

Charging the battery

- 5** Charging has finished when the battery indicator changes to .

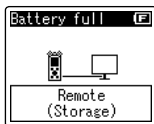

Charging time: About 3 hours*

- * Approximate time needed to fully charge a completely flat battery at room temperature.

Battery charging time will depend on the amount of remaining power and the state of the battery.

Charging the battery

1

Charging the battery

Charging the battery by connecting to an AC adapter with a USB connection (model A514; optional)

NOTE

- Before connecting the AC adapter, select **[AC Adapter]** for the USB connection setting (P.91).
- Before charging the battery, insert the rechargeable battery provided and set **[Battery]** to **[Ni-MH]** (P.9, P.10).
- Use only the Olympus USB connecting AC adapter model provided (A514).

- 1 **Connect the voice recorder to the USB connector on the AC adapter.**

To USB connector of AC adapter (model A514)

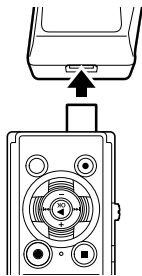

- 2 **Connect the AC adapter to an AC power outlet.**

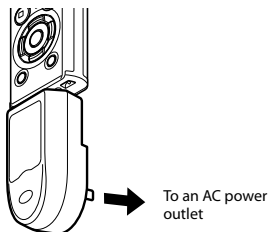

- 3 **Press the ►OK button to start charging.**

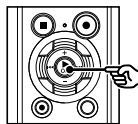

- When **[Battery]** (P.73) is set to **[Ni-MH]**, **[Press OK to start charging]** appears on the display. Press the ►OK button while this message is blinking.

4 Charging is finished when [Battery full] appears.

When charged with the power turned off

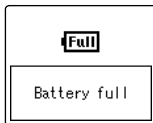

Displayed when the battery is fully charged

When charged with the power turned on



NOTE

- The power of the PC must be ON to charge the battery using the USB connector. You cannot charge the battery when the power of the PC is OFF, or the PC is in standby, sleep or auto power OFF mode.
- Do not use a USB hub when charging the battery by connecting to the PC.
- You cannot charge the battery if []^{*1} or []^{*2} is blinking. Charge the battery in an ambient temperature of between 5 and 35°C (41 and 95°F).
 - *1 [] Ambient temperature is too low.
 - *2 [] Ambient temperature is too high
- If battery life has become noticeably short on a full charge, replace the battery with a new one.
- Insert the USB connector securely all the way. Operation will not be normal if the connection is not made properly.
- Use only a compatible Olympus USB extension cable. Operation is not guaranteed if another manufacturer's cable is used. Only use the Olympus USB extension cable with the voice recorder and never use if a product from another manufacturer is used.
- To charge the battery with [USB Settings] set to [Composite], set [USB Connection] to [Optional] before charging. When you select [AC Adapter] for the [USB Connection] you can charge the battery (P.91).

Batteries



1

Batteries

Battery indicator

As the battery loses its remaining charge, the battery indicator on the display changes as follows:



- [] indicates there is little remaining battery charge. Charge the battery or replace it with a fresh one. When the battery has run out, [] and **[Battery low]** appear, and operation stops.

Rechargeable batteries

Read the information below carefully when using a nickel-metal hydride rechargeable battery (model BR404).

■ Discharging

Rechargeable batteries discharge naturally when not in use. Be sure to charge the battery before use.

■ Operating temperature

Rechargeable batteries are chemical-based products. Their performance can vary even when used within the recommended operating temperature range. This variation is normal.

■ Recommended temperature ranges

When powering voice recorder: 0 to 42°C (32 to 107.6°F)

When being charged: 5 to 35°C (41 to 95°F)

During long-term storage: -20 to 30°C (-4 to 86°F)

Use of a rechargeable battery outside the temperature ranges above may result in drops in battery performance or life. When not using the voice recorder for an extended period, remove the rechargeable battery before storage to prevent fluid leakage or rust.

■ Disposal

Always dispose rechargeable batteries in the legally prescribed manner. Before disposing rechargeable batteries that are not fully discharged, take steps to prevent shorting such as insulating their terminals with tape.

NOTE

- Due to the nature of nickel-metal hydride rechargeable batteries, new batteries and batteries not used for an extended period (one month or more) may not charge completely. The battery should become fully charged after charging and discharging the battery up to three times.
- When buying rechargeable batteries, always select model BR404 nickel-metal hydride rechargeable batteries. Operation is not guaranteed if a battery from another manufacturer is used.
- The continuous battery usage time of a nickel-metal hydride rechargeable battery that has been used repeatedly will be reduced due to battery degradation (☞ P.127).

Battery precautions

- The voice recorder does not support manganese batteries.
- Always turn power OFF before replacing the battery. Files may be damaged if the battery is removed while the voice recorder is recording or performing an operation such as erasing a file.
- If the batteries are removed from the voice recorder, the [Time & Date] screen is displayed automatically when the power is turned on. See “**Setting the time/date [Time & Date]**” (E3P P.74) for the procedure.
- When not using the voice recorder for an extended period, always remove the battery before storage.
- When replacing the battery, use an AAA alkaline dry cell battery or an Olympus nickel-metal hydride rechargeable battery (model BR404).
- Even if the battery indicator is [||||], playback with the built-in speaker at some volumes may result in a drop in battery output voltage, causing the voice recorder to reset. Lower the volume in this case.
- The battery indicator may differ between when the internal memory is used and when a microSD card is used.
- The continuous battery usage time is reduced when using a microSD card (E3P P.127).
- The continuous battery usage time will vary depending on the performance of the battery in use (E3P P.127).
- The [Battery] screen appears automatically after you have replaced the battery. You can also use a menu operation to display this screen and set the battery (E3P P.73).

For users in Germany

Olympus has an agreement with the GRS (Joint Battery Disposal Association) in Germany to ensure environmentally-friendly battery disposal.

Inserting/removing a microSD card

The voice recorder has its own internal memory, and also supports standard microSD cards (microSD, microSDHC) sold separately.

1

Inserting a microSD card

Inserting/removing a microSD card

- 1 While the voice recorder is in stop mode, open the battery/card cover.

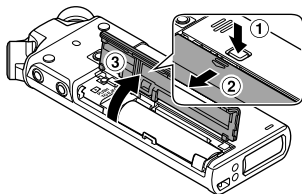

- The microSD card slot is inside the battery/card cover.

- 2 Insert a microSD card, making sure it is placed correctly as shown.

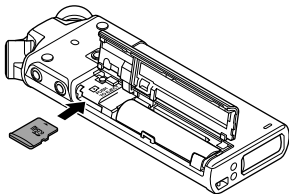

- Insert the microSD card straight, avoiding crooked insertion.
- Inserting a microSD card the wrong way or crookedly could damage its contact surface or cause it to jam in the slot.
- A microSD card not inserted fully (until it clicks into place) might not record data.

- 3 Close the battery/card cover.

- The recording media selection screen appears after a microSD card has been inserted.

- 4 To record onto the microSD card, press the + or – button and select [Yes].

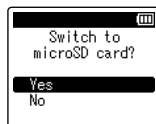
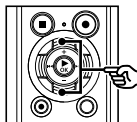

- 5 Press the ►OK button to finalize the setting.

TIP

- You can also select the internal memory as the recording media (☞ P.73).

NOTE

- The voice recorder may not be able to recognize a microSD card formatted (initialized) for a PC or other device. Before using a microSD card, always initialize it on the voice recorder (☞ P.93).

Inserting/removing a microSD card

Removing a microSD card

- 1 While the voice recorder is in stop mode, open the battery/card cover.

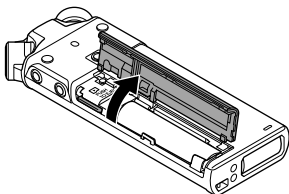

- 2 Release the microSD card by pressing it inward, then letting it slowly return.

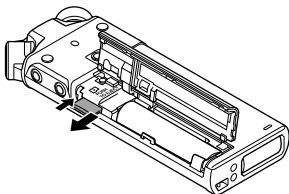

- The microSD card moves outward and stops. Pull the microSD card out with your fingertips.
- **[Internal memory selected]** is displayed after removing a microSD card if **[Memory Select]** was set to **[microSD card]**.

- 3 Close the battery/card cover.

NOTE

- microSD cards may pop out forcefully on removal if you flick or release your finger too quickly after pressing the card in.
- Depending on the card's manufacturer and type, some microSD cards and microSDHC cards may not be fully compatible with the voice recorder and not be recognized properly.
- For microSD card compatibility under Olympus verification, please contact our customer support at:

<http://www.olympusamerica.com>
(The Americas)

<http://www.olympus-europa.com>
(Europe, Oceania)

Note that our customer support will provide information on microSD card manufacturers and card types for which Olympus has verified operation, but will not guarantee its performance.

Also note that some cards may no longer be recognized correctly by the voice recorder in case card manufacturer changes card specifications.

- Read the operating instructions provided with the card when using a microSD card.
- If a microSD card is not recognized by the voice recorder, try removing and reinserting the card to have the voice recorder attempt recognition again.
- Processing speed may be low for some microSD card types. Processing performance may also be reduced by writing or deleting data repeatedly from a microSD card. In this case, reinitialize the card (P.93).

Preventing accidental operation

Setting the voice recorder to HOLD mode maintains the current operation and disables button operations. HOLD mode is a handy feature for preventing unintentional operation from accidental button presses when the voice recorder is carried in a bag or pocket. It is also useful for preventing the voice recorder being accidentally stopped during recording.

1

Preventing accidental operation

Setting HOLD mode

- 1 Slide the **POWER/HOLD** switch to the **[HOLD]** position.

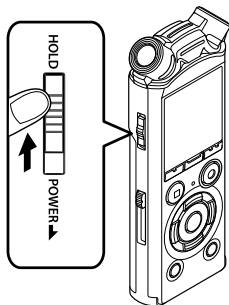

Releasing HOLD mode

- 1 Slide the **POWER/HOLD** switch to position **A** shown below.

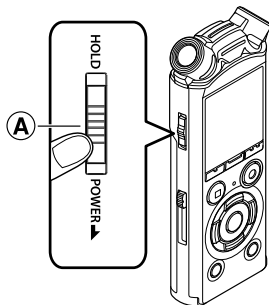

- **[Hold]** appears in the display, and the recorder enters HOLD mode.

NOTE

- When any button is pressed during HOLD mode, **[Hold]** appears in the display for 2 seconds. No other operation is performed.
- Setting HOLD mode during voice recorder playback (or recording) continues the playback (or recording) operation and prevents any other operation from being performed. (The voice recorder stops when playback ends or when recording ends because, for example, there is no remaining memory space.)

Turning the power OFF

Existing data, mode settings and the clock setting are saved when the power is turned off.

- 1 Slide the **POWER/HOLD** switch in the direction of the arrow for at least half a second.

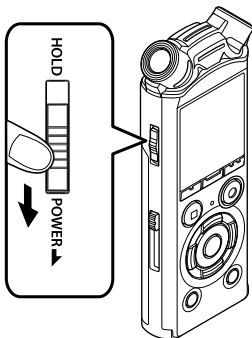

- The playback stop position at power OFF is stored in memory.

TIP

- Turning the power OFF whenever the voice recorder is not in use minimizes battery consumption.

Power Save mode

When the voice recorder has been stopped for at least 10 minutes (default setting) after power ON, the display disappears and the voice recorder automatically enters power save mode (P.73).

- Pressing any button releases power save mode.

[Home] screen operations

Selecting the mode

1

In addition to its recording function, the voice recorder also provides music player functions. Choose the application you want by selecting one of the voice recorder's modes.

[Home] screen operations

- 1 While the voice recorder is in stop mode, press the **F1 (HOME)** button to display the **[Home]** screen.

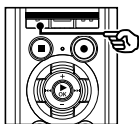

When **[Recorder]** is selected:

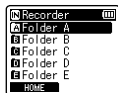

The voice recorder enters **[Recorder]** mode. Audio can be recorded with the built-in microphone. Files recorded with the built-in microphone can also be played back (see P.27, P.39).

- 2 Press the **▶▶▶** or **◀◀◀** button to select the desired mode.

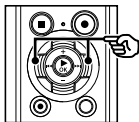

When **[Music]** is selected:



The voice recorder enters **[Music]** mode. In this mode you can play music files transferred to the voice recorder (see P.39).

- 3 Press the **▶OK** button.

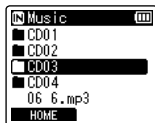
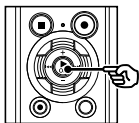

When **[Calendar Search]** is selected:

The voice recorder enters **[Calendar Search]** mode. In this mode you can search for files by specifying the recording date (see P.51).

Selecting folders and files

You can select a different folder while the voice recorder is in stopped or playing a file. See “**Transferring files to a PC**” (P.108) for a description of the voice recorder’s hierarchical folder structure.

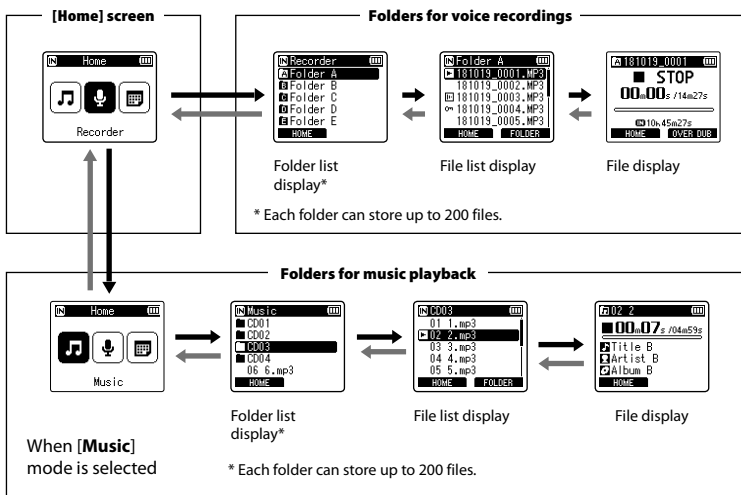

→ Forward: ► OK button

Each press on the ►OK button opens the currently selected folder or file in the list, moving forward to the next (lower) level in the folder hierarchy. When a list is displayed, you can perform the same function by pressing the ►►I button.

← Back: LIST button

Each press on the LIST button moves back to the previous (higher) level in the folder hierarchy. When a list is displayed, you can perform the same function by pressing the I◀◀ button.

TIP

- When navigating through a folder hierarchy, you can press and hold the LIST button to return to the file display.

+ or – button

Used to select a folder or file.

Selecting folders and files

1

Selecting folders and files

[Home] screen

Used to select the voice recorder mode
( P.22).

List display

Displays the folders and files recorded in
the voice recorder.

Pressing the **F2 (FOLDER)** button changes
the display to the list display of the next
folder.

File display

Displays the information of the selected file.

Attaching the tripod adapter (TR2)

Use this adapter when fixing the voice recorder to a tripod. It changes the diameter of the hole at the back of the voice recorder to 1/4 inch.

- 1 Attach the adapter to the attachment mounting hole at the back of the voice recorder.**

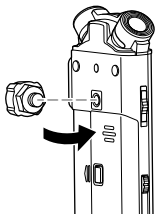

- 2 Turn the screw of the adapter with your fingers to fix the adapter to the voice recorder.**

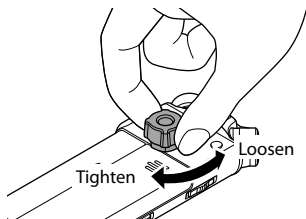

NOTE

- Do not use a spanner or other tool to strongly tighten when attaching the adapter to the voice recorder. The voice recorder may be damaged.

Handling precautions for the adapter

When operating the voice recorder while it is fixed to a tripod, operate it while holding the voice recorder. If a button is strongly pressed when the voice recorder is not being held, the voice recorder may be damaged.

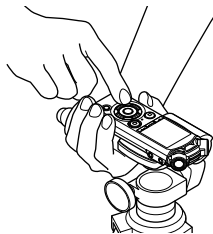

If the fixing screw of the tripod and the adapter cannot be detached, detach the part shown in the figure using an M10 size spanner or other tool.

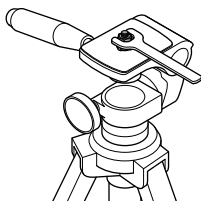

Attaching the tripod adapter (TR2)

1

Attaching the tripod adapter (TR2)

NOTE

- Do not strongly tighten when attaching the adapter to the voice recorder. Damage may result.
- Do not attach other than a dedicated attachment. The voice recorder may be damaged.
- When attaching a tripod, turn the screw of the tripod and not the voice recorder.
- Remove a dedicated attachment before opening the battery/card cover.

Recording

Recording

The voice recorder has five folders ([A] to [E]) in which recorded files can be saved. These folders provide a handy way to sort recordings into separate categories (such as business and leisure).

Basic recording procedure

- 1 Press the ►► or ◀◀ button in the [Home] screen and select [Recorder] (P.22).
- 2 Press the ► OK button.
- 3 Press the + or – button to select the folder to save the recording in.

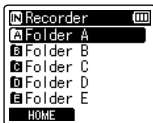
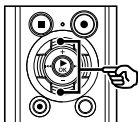

- Each new voice recording file is saved in the selected folder.

- 4 Press the REC (●) button to prepare for recording.

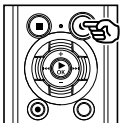

- a Level meter (changes according to recording volume and recording function setting)
- The recording indicator light blinks.

- 5 Point the built-in microphone in the direction of the sound to record.



- 6 Press the ►► or ◀◀ button to adjust the recording level.

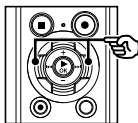

- b Recording level

NOTE

- Adjust the recording level so that it does not exceed the peak of the level meter while checking the meter. If the peak of the level meter is exceeded, the **PEAK** indicator light will light and the recorded audio may be distorted.

7 Press the REC (●) button to start recording.

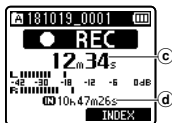
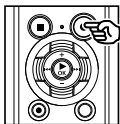

- Ⓒ Elapsed recording time
- Ⓓ Remaining possible recording time
- The recording indicator light lights.
- If you record simple recording content at the beginning, it will be convenient for searching later using the [Intro Play] function (only for LS-P4 model) (☞ P.72).

8 Press the STOP (■) button when you want to stop recording.

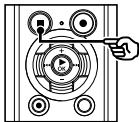

- Ⓔ File length

Sound files recorded with the voice recorder are automatically given a file name in the format below.

181001_0001.MP3

①

②

③

① Date recorded

Indicates the year, month and day the recording was made.

② File number

Appended file numbers are consecutive regardless of whether the recording media has been switched.

③ Extension

A file extension indicating the recording format the file was recorded in by the voice recorder.

- Linear PCM format: ".WAV"
- FLAC* format: ".FLAC"
- MP3 format: ".MP3"

* LS-P4 model only

TIP

- [Rec Mode] must be set with the voice recorder stopped (☞ P.61).
- Pressing the REC (●) button starts recording even in [Music] or [Calendar Search] mode. So you will be able to respond quickly in the event of a sudden recording opportunity. The recorded file will be saved to [Folder A].

NOTE

- To prevent the beginning of the recording being cut off, start recording after the recording indicator light has lit or mode indicator has appeared in the display.
- When the remaining possible recording time is 60 seconds, the LED indicator light starts flashing. It flashes more rapidly as the remaining time decreases (at the 30- and 10-second points).
- When **[Folder full]** appears, no more recording can be done. To record more, you will need to select a different folder or delete unneeded files (☞ P.52).
- If **[Memory full]** appears, the voice recorder has no more available memory space. You will need to delete unneeded files to record more (☞ P.52).
- When using a microSD card in the voice recorder, be sure the desired recording media setting (**[Internal memory]** or **[microSD card]**) has been selected (☞ P.73).
- Processing performance may be reduced when data has been repeatedly written to or deleted from the recording media. Please initialize the recording media in this case (☞ P.93).

Recording linear PCM format files of over 2 GB

When recording a linear PCM format file, recording will continue even after the file size exceeds 2 GB.

- The data is divided and saved in separate files of up to 2 GB. The files are processed as multiple files during playback.
- After recording 200 files which exceed 2GB recording stops.

Recording FLAC format files

- FLAC format adopts “variable bit rate” that changes the bitrate of a file, so the remaining recordable time indication may differ from the actual recordable time. Confirm that the remaining memory capacity is sufficient before recording.
- Recording a FLAC format file is not possible when connected with a Bluetooth® device. If you connect a Bluetooth® device to this recorder and start recording when **[FLAC]** is set for **[Rec Mode]**, the **[Rec Mode]** setting automatically changes to **[PCM]**.

 **LS-P4 model only**

Pausing/resuming recording

- 1 Press the **REC (●)** button during recording.

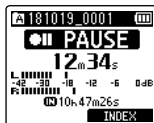
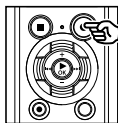

- Recording pauses, and the blinking message [● | PAUSE] appears in the display.
- Recording is stopped automatically after being paused for at least 60 minutes.

- 2 Press the **REC (●)** button again while recording is paused.

- Recording resumes from the position it was paused at.

Quickly checking a recording

- 1 Press the **▶ OK** button during recording.

- Recording ends, and the file just recorded is played.

Recording settings

Various recording settings are available, letting you tailor recording to different recording conditions.

[Rec Level] (P.60)	Sets the recording level.
[Limiter] (P.61)	Sets the correction method according to the sound input during recording.
[Rec Mode] (P.61)	Sets the recording sound quality.
[Zoom Mic] (P.62)	Sets the built-in stereo microphone's directivity.
[Low Cut Filter] (P.63)	Reduces humming sounds from equipment such as air-conditioners or projectors.
[Mic Select]* (P.63)	Selects whether or not the built-in center microphone is to be turned on or off.
[VCVA] (P.64)	Sets the trigger level for voice-activated recording (VCVA).
[V-Sync. Rec] (P.65)	Sets the trigger level for voice-synchronized recording.
[Rec Scene] (P.32)	Used to select one of multiple preregistered templates of recording settings. When selected, each template enters several settings tailored to a particular recording location or condition all in a single operation.

* LS-P4 model only

Monitoring while recording

You can monitor the recording as you are making it by listening on the earphones plugged into the voice recorder's earphone jack (🎧). Use the + or – button to adjust the recording monitor volume.

- The earphones are optional.

1 Connect the earphones to the voice recorder's earphone jack (🎧).

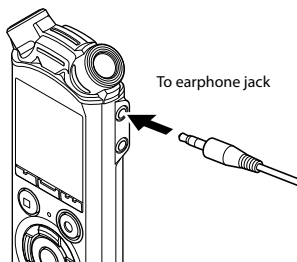

- Changing the volume will not affect the recording level.







NOTE

- To avoid unpleasantly loud sound, set the volume to [00] before plugging in the earphone.
- To prevent feedback, do not place the earphone near the microphone while recording.

Selecting the automatic recording setting [Rec Scene]

Changing the recording scene

The voice recorder has preregistered templates of optimum settings tailored to various recording applications such as lectures and dictation. When selecting one of these templates you can enter several settings recommended for your recording application all in a single operation.

[Lecture]		Suitable for recording with the microphone pointed in a specific direction such as at a large venue where the speaker is far away.
[Conference]		Suitable for recording conferences in a large space and other sounds over a wide area.
[Meeting]		Suitable for recording meetings held in a small space and other sounds that are fairly close.
[Dictation]		Suitable for recording your own voice and other sounds that are extremely close.
[NoisySituation]*		Suitable for recording your own voice and other sounds that are extremely close while reducing surrounding noise.
[Music]		Suitable for recording realistic audio with exceptional clarity such as live recording of a musical instrument performance or out in the open air.
[DNS]		Suitable for Speech Recognition Software.

* LS-P4 model only

- 1 While the voice recorder is in stop mode, press and hold the MENU/SCENE button.**

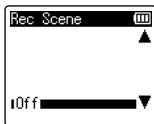
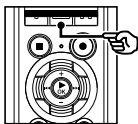

- 2 Press the + or – button to select the desired recording application.**

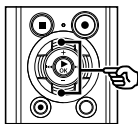

TIP

- Press the ►► button to display the settings of the selected template. Press the ◀◀ button to return to the [Rec Scene] screen.

Selecting the automatic recording setting [Rec Scene]

3 Press the **▶OK** button to finalize the setting.

4 Press the **STOP** (■) button to exit the selection screen.

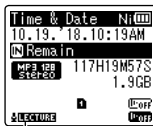
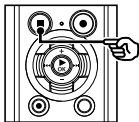

Rec Scene

- Press and hold the **STOP** (■) button when the recorder is stopped to check setting indicators meanings.

NOTE

- Other functions of [Rec Menu] are disabled when [Rec Scene] is set. The [Rec Scene] setting automatically changes to [OFF] when a function of [Rec Menu] is set.

Preregistered [Rec Scene] settings

[Lecture]

[Rec Level]	[High]
[Rec Mode]	[MP3 128 kbps]
[Zoom Mic]	[+6]
[Low Cut Filter]	[0n]
[Mic Select]*	[Central Mic Off]
[VCVA]	[Off]
[V-Sync. Rec]	[Off]

[Conference]

[Rec Level]	[Auto]
[Rec Mode]	[MP3 128 kbps]
[Zoom Mic]	[Off]
[Low Cut Filter]	[0n]
[Mic Select]*	[Central Mic Off]
[VCVA]	[Off]
[V-Sync. Rec]	[Off]

[Meeting]

[Rec Level]	[Middle]
[Rec Mode]	[MP3 128 kbps]
[Zoom Mic]	[Off]
[Low Cut Filter]	[Off]
[Mic Select]*	[Central Mic Off]
[VCVA]	[Off]
[V-Sync. Rec]	[Off]

[Dictation]

[Rec Level]	[Low]
[Rec Mode]	[MP3 128 kbps]
[Zoom Mic]	[Off]
[Low Cut Filter]	[0n]
[Mic Select]*	[Central Mic Off]
[VCVA]	[Off]
[V-Sync. Rec]	[Off]

Selecting the automatic recording setting [Rec Scene]

2

Selecting the automatic recording setting [Rec Scene]

[NoisySituation]*

[Rec Level]	[Low]
[Rec Mode]	[MP3 64 kbps mono] (sampling frequency 16 kHz)
[Zoom Mic]	[Off]
[Low Cut Filter]	[On]
[Mic Select]*	[Central Mic Off]
[VCVA]	[Off]
[V-Sync. Rec]	[Off]

[Music]

[Rec Level]	[Low]
[Rec Mode]	[PCM 44.1 kHz/16 bit]
[Zoom Mic]	[Off]
[Low Cut Filter]	[Off]
[Mic Select]*	[Central Mic On]
[VCVA]	[Off]
[V-Sync. Rec]	[Off]

[DNS]

[Rec Level]	[Low]
[Rec Mode]	[MP3 128 kbps]
[Zoom Mic]	[Off]
[Low Cut Filter]	[Off]
[Mic Select]*	[Central Mic Off]
[VCVA]	[Off]
[V-Sync. Rec]	[Off]

* LS-P4 model only

NOTE

- For recording when [NoisySituation]* is set, point the built-in microphone on the top left or top right of the voice recorder toward the speaker and place it in an upright position as close as approximately 3 cm from the speaker's mouth.

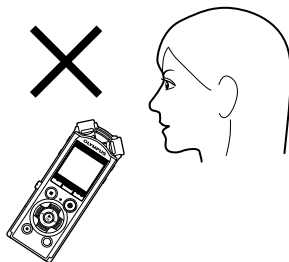
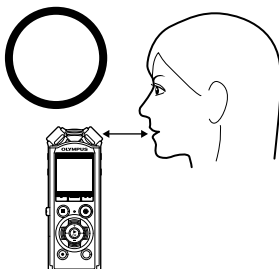

- When [NoisySituation]* is set, the noise reduction function is enabled while recording.

* LS-P4 model only

Overdubbing

Selecting a file for overdubbing

You can overdub a file while listening to its playback sound. The overdubbed file is saved with a different name. This function is useful for composing music or practicing musical instruments.

LS-P4 model only

TIP

The following is required for using the [OVER DUB] function.

- Select a file recorded in the [PCM 44.1kHz/16bit] or [PCM 44.1kHz mono] (.wav) format for overdubbing (P.23, P.39).
- Set [PCM 44.1kHz/16bit] or [PCM 44.1kHz mono] for [Rec Mode] beforehand (P.61).

1 Connect the earphones to the voice recorder's earphone jack (🎧).

- The playback sound is output from the earphones.

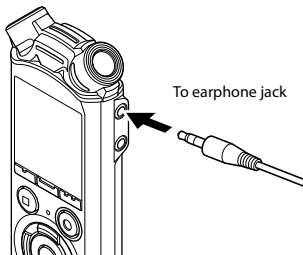

2 Select a file to be overdubbed (P.23).

3 Press the F2 (OVER DUB) button in stop mode.



- Playback starts from the beginning of the file simultaneously with start of overdubbing.

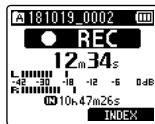

4 Press the STOP (■) button when you want to stop recording.

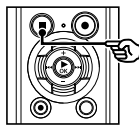

- Overdubbing is ended when the playback is finished.

NOTE

• The **[OVER DUB]** function is not possible when the following functions are set.

- **[While recording]** (E30 P.77)
- **[VCVA]** (E30 P.64)
- **[V-Sync. Rec]** (E30 P.65)
- **[Bluetooth]*** (E30 P.75)

* LS-P4 model only

Recording with an external microphone

You can record audio input using an external microphone or other device connected to the voice recorder's microphone jack (🎧). Do not plug or unplug devices into/from voice recorder jacks while recording.

1 Connect an external microphone to the voice recorder's microphone jack (🎧).

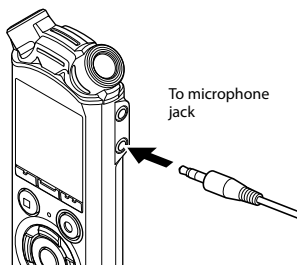

2 Start recording.

- See “Recording” (📖 P.27) for descriptions of recording operations.

TIP

- See “Accessories (optional)” (📖 P.117) for the compatible external microphones.

NOTE

- Microphones with plug-in power supplies can be used.
- When [Rec Mode] is set to stereo, recording with an external mono microphone records on the left channel only (📖 P.61).
- When [Rec Mode] is set to mono, only the input from the left channel microphone is recorded when using an external stereo microphone (📖 P.61).

Recording from another connected device

Recording audio from another device with this recorder

Audio can be recorded when you have connected the audio output terminal (earphone jack) of another device and the microphone jack (🎧) of the recorder by using the connecting cord KA333 (optional) for duplication.

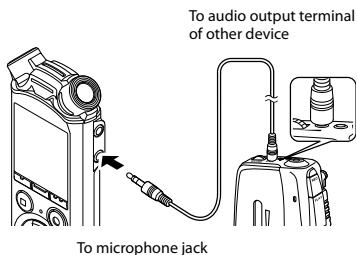

NOTE

- When recording from a connected external device, perform a test recording and adjust the output level of the connected device as needed.

Recording audio from this recorder with another device

Audio from this recorder can be recorded to another device by connecting the audio input terminal (microphone jack) of the other device and the earphones jack of this recorder using the connecting cord KA333 (optional).

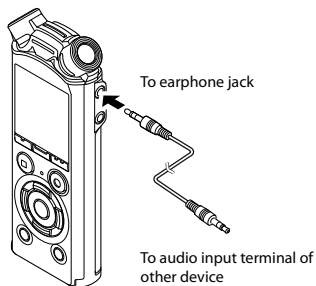

NOTE

- Adjusting playback sound quality settings on the voice recorder affects the audio output signals output from the earphones jack (P.67 to P.69).

Playback

Playback

In addition to files recorded by the voice recorder, you can also play WAV, FLAC (LS-P4 model only) or MP3 format files transferred from a PC.



Basic playback procedure

- 1 Select the file to play from the folder containing it (see P.23).

TIP

- Files are saved in the locations below.

Files recorded with the built-in microphone:

[Recorder] folders (folders  to )

Music files transferred from a PC:
[Music] folder

- 2 Press the **▶ OK** button to start playback.

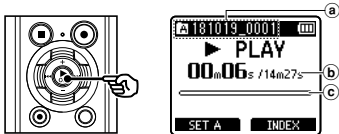

- Folder indicator / File name
- Elapsed playback time / File length
- Playback position bar indicator

- 3 Press the **+** or **-** button to adjust the volume to the desired level.

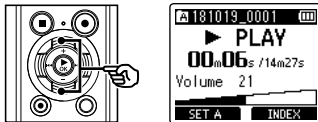

- The volume can be adjusted to a setting between [00] to [30]. The higher the number, the louder the volume.
- If the volume is set too loud, a warning screen may appear.

- 4 Press the **STOP** () button to stop playback.

- The file being played stops right away. The resume function automatically stores the playback stop position in memory. The position is retained even if the power is turned off. The next time the power is turned on, playback can be resumed from the stop position stored in the memory.

Fast-forwarding

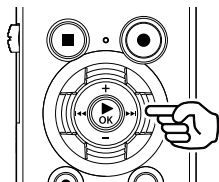

Fast-forwarding while the voice recorder is in stop mode

1 With the voice recorder stopped, press and hold the ►►| button.

- Fast-forwarding stops when you release the ►►| button. Press the ►OK button to start playback from the current position.

Fast-forwarding during playback

1 Press and hold the ►►| button during playback.

- Playback starts from the current position when you release the ►►| button.
- If an index mark or temp mark in the file is reached, fast-forwarding stops at the mark (☞ P.48).
- Fast-forwarding stops when the end of the file is reached. Press and hold the ►►| button again to fast-forward from the beginning of the next file.

Rewinding

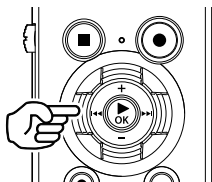

Rewinding while the voice recorder is in stop mode

1 With the voice recorder stopped, press and hold the ◀◀| button.

- Rewinding stops when you release the ◀◀| button. Press the ►OK button to start playback from the current position.

Rewinding during playback

1 Press and hold the ◀◀| button during playback.

- Playback starts from the current position when you release the ◀◀| button.
- If an index mark or temp mark in the file is reached, rewinding stops at the mark (☞ P.48).
- Rewinding stops when the beginning of the file is reached. Press and hold the ◀◀| button again to rewind from the end of the previous file.

Skipping to the beginning of a file

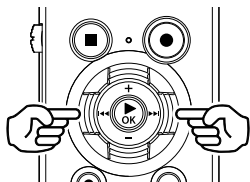

Skipping to the beginning of the next file

- 1 Press the **▶▶|** button while the voice recorder is in stop mode, or during playback.

Skipping to the beginning of the current file

- 1 Press the **◀◀|** button while the voice recorder is in stop mode, or during playback.

Skipping to the beginning of the previous file

- 1 Press the **◀◀|** button when the playback position is the beginning of the file.
 - To skip to the beginning of the previous file during playback, press the **◀◀|** button twice consecutively.

NOTE

- If an index mark or temp mark is reached when skipping to the beginning of a file during playback, playback starts from the position of the mark. When skipping to the beginning of a file while the voice recorder is in stop mode, the mark is ignored (E38 P.48).
- If a setting other than **[File Skip]** is set for **[Skip Space]**, playback starts after the set amount of time has been skipped backwards or forwards. Playback does not skip to the beginning of the file.

Playback settings

You can select various file playback methods tailored to different applications and tastes.

[Voice Playback]^{*1} (<small>ESP</small> P.67)	Only plays voice portions of a recorded audio file.
[Noise Cancel]^{*1} (<small>ESP</small> P.67)	A setting that makes recorded voices more discernable when muffled by projector noise or similar sounds.
[Voice Balancer]^{*1} (<small>ESP</small> P.68)	Compensates low-volume portions of recorded audio files during playback.
[Play Mode] (<small>ESP</small> P.68)	Selecting from among three playback modes.
[Equalizer]^{*2} (<small>ESP</small> P.69)	Adjusts the quality of sound as desired.
[Skip Space] (<small>ESP</small> P.70)	A handy function for quickly moving the playback position, and playing short segments repeatedly.

*1 Function active only in **[Recorder]** mode.

*2 Function active only in **[Music]** mode.

Playback through the earphones

You can connect the earphones to the voice recorder's earphone jack (🎧) and listen to playback through them.

- The earphones are optional.

1 Connect the earphones to the voice recorder's earphone jack (🎧).

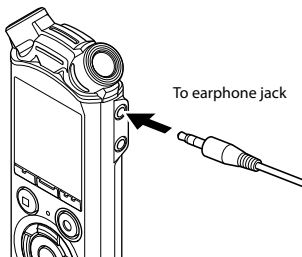

2 Press the ► OK button to start playback.

TIP

- There will be no sound from the speaker when the earphones are connected.

NOTE

- To avoid unpleasantly loud sound, set the volume to [00] before plugging in the earphone.
- Avoid excessive volume when listening to playback through the earphones. It may cause hearing damage or loss.
- If the volume is set too loud, a warning screen may appear.

Music files

If a music file transferred to the voice recorder is unplayable, check that its sampling rate, bit count and bit rate values are within the supported ranges. The sampling rate, bit count and bit rate combinations supported for music file playback by the voice recorder are shown below.

File format	Sampling rate	Bit count/ bit rate
WAV format, FLAC* format	44.1 kHz, 48.0 kHz, 88.2 kHz, 96.0 kHz	16 bits, 24 bits
MP3 format	MPEG 1 Layer 3: 32 kHz, 44.1 kHz, 48 kHz MPEG 2 Layer 3: 16 kHz, 22.05 kHz, 24 kHz	8 to 320 kbps

* LS-P4 model only

- MP3 files with variable bit rates (bit rates converted variably in a single file) may not play normally.
- Linear PCM-format WAV files are the only WAV files the voice recorder can play. Playback of other WAV files is not supported.
- Even if the file formats is compatible for playback on this recorder, the recorder does not support every encoder.

Changing the playback speed

Changing the playback speed is handy for speeding up conference presentations, or for slowing down parts difficult to discern when learning a language.

- 1 Press the ►OK button during playback.

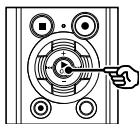

TIP

- When changing the playback speed, playback operations such as stopping playback, skipping to the beginning of a file, and writing index marks/temp marks are the same as during standard playback.

- 2 Press the + or – button.

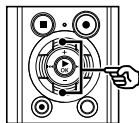

NOTE

- Altered playback speed settings are retained even after power OFF.
- Changing the playback speed will make the battery deplete more quickly.

- The playback speed can be adjusted between [x0.5 Play] and [x3.5 Play] in 0.1 increments.
- The playback speed increases when the + button is pressed, and decreases when the – button is pressed.
- To return to the normal playback speed, set the setting to [x1.0 Play].

- 3 Press the ►OK button to finalize the setting.

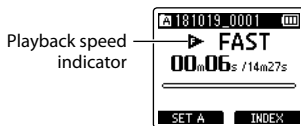

Fast playback restrictions

Depending on their sampling frequency and bit rate, some files may not play normally. In this case, you will need to reduce the playback speed.

ABC repeat playback

The voice recorder has a function with which you can repeat the playback of a portion (segment) of the file being played. In addition to the A-B repeat function available from previous models, the segment to repeat can be changed during repeat playback.

ABC repeat playback

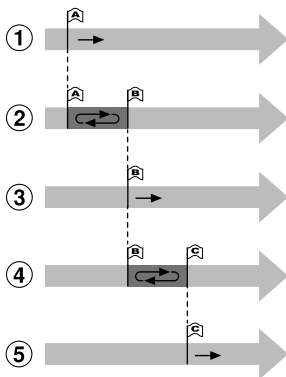

- 1 Select the starting point for repeat playback (A) during playback.
- 2 When the ending point (B) is selected, repeat playback starts.
- 3 When the starting point for repeat playback (A) is canceled during repeat playback, the ending point of the segment (B) becomes the new starting point and playback continues.
- 4 When the ending point (C) is selected, repeat playback starts again.
- 5 These steps can be repeated to re-specify a new segment to be played back repeatedly up to the end of the file.

- 1 Select a file for ABC repeat playback, and start playback.
- 2 Press the F1 (SET A) button when playback reaches the desired start position for ABC repeat playback.



TIP

- You can change the playback speed (Ⓜ P.44), and fast-forward/rewind (Ⓜ P.40) when the [A] indicator is blinking.
- If playback reaches the end of the file when the [B] indicator is blinking, the end of the file is treated as the segment end position, and repeat playback starts.

ABC repeat playback

3

ABC repeat playback

- 3 Press the F1 (SET B) button again when playback reaches the desired end position for ABC repeat playback.**



- Segment A-B is set, and ABC repeat playback starts.

Stopping ABC repeat playback:

☞ Go to Step 6

Specifying new starting/ending points:

☞ Go to Step 4

Specifying new starting/ending points

- 4 Press the F1 (CANCEL A) button during ABC repeat playback.**

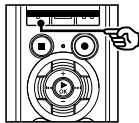

- Segment A-B is canceled. [B] becomes the new start position, and playback continues.
- You can change the playback speed (☞ P.44), and fast-forward/rewind (☞ P.40).

- 5 Press the F1 (SET C) button at the desired end position for ABC repeat playback.**



- Segment B-C is set, and ABC repeat playback starts.

TIP

- You can repeat Steps 4 and 5 as needed to change the repeat segment as desired.

- 6 Press the STOP (■) button.**

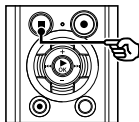

- Playback stops. The playback segment specified for this function is retained.

ABC repeat playback

NOTE

- You cannot change the end position of a repeat playback segment to a position before the start position.
- You cannot write index marks or temp marks during ABC repeat playback (P.48).

Canceling ABC repeat playback

1 Press the F2 (CNCL ABC) button.



- If pressed when ABC repeat playback is stopped, cancels ABC repeat playback.
- If pressed during ABC repeat playback, cancels the playback segment setting for the function, and continues standard playback.

NOTE

- If you change the file or switch to different display screen, ABC repeat playback is canceled.

Index marks/temp marks

Writing an index mark or temp mark in a file enables you to quickly access desired position in the file with the same operations used for fast-forwarding, rewinding or skipping to the start of a file. You can write index marks in files created with this recorder. For files created with devices other than Olympus voice recorders and files in which index marks cannot be written, you can write temp marks in a file being played, for temporarily remembering desired positions.

Writing an index mark/temp mark

3

Index marks/temp marks

- 1 When the desired position has been reached press the F2 (INDEX) button to write an index mark or temp mark.



NOTE

- Temp marks are temporary markings. They are automatically erased when you select a different file, transfer the file to a PC, or move the file on a PC.
- If files created with this recorder are played on a PC, index marks may become unable to be written in the files.
- You can write up to 99 (16¹¹) index marks/temp marks in a single file. The message [**Further marking not possible**] appears if you attempt to write more than 99 (16¹¹) marks.
- You cannot write or erase index marks/temp marks in files that have been locked by the file lock function (P.57).
- You cannot write index marks in FLAC² format files.

*1 LS-P1 model only

*2 LS-P4 model only

Index marks/temp marks

Erasing an index mark/temp mark

- 1 Select a file that contains index mark/temp mark you want to erase and start playback.
- 2 Use the **▶▶** or **◀◀** button to select the index mark/temp mark you want to erase.

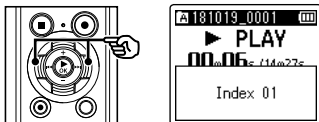

- 3 When the number of the index mark/temp mark to erase is being shown (for about 2 seconds) in the display, press the **ERASE** button.

- Any subsequent index marks/temp marks in the file are automatically renumbered.

Erasing all index marks at once

! LS-P4 model only

You can erase all index marks in a file at once.

- 1 Select a file that contains index/temp marks you want to erase (see P.23).
- 2 When the file display screen appears, press the **ERASE** button while the voice recorder is in stop mode.



- The voice recorder returns to the stopped mode if no operation is performed for 8 seconds.

- 3 Press the **+** or **-** button to select **[Indexes in a file]**.



Index marks/temp marks

- 4 Press the ►OK button.

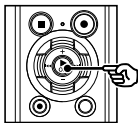

- 5 Press the + button to select [Start].

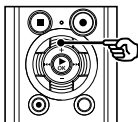

- 6 Press the ►OK button.

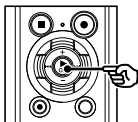

- **[Erasing!]** appears in the display, and the erasing process starts. **[Erased]** appears when the process has finished.

3

Index marks/temp marks

Calendar Search function

You can search for voice files by specifying a recording date. If you have forgotten in which folder a file has been saved, with this feature you can access it quickly by entering its recording date.

NOTE

- You can only search for files saved in [Recorder] folder.

- While the voice recorder is in stop mode, press the **F1 (HOME)** button to display the [Home] screen.
- Press the **▶▶** or **◀◀** button to select [Calendar Search].

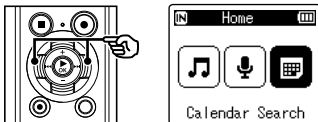

- Press the **▶ OK** button.
- Press the **+**, **-**, **▶▶** or **◀◀** button to select the desired date.

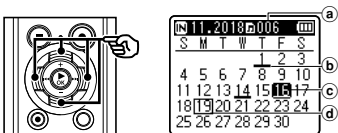

- Number of files saved (recorded) on selected date
- Date file was recorded
- Selected date
- Today's date

- Dates on which files were saved are underlined.
- ▶▶, ◀◀** button:
Move to the previous/next date. Press and hold to skip to the next date on which a file was recorded.
- +**, **-** button:
Move to the previous/next week.
- F1, F2** button:
Move to the previous/next month.
- Press the **STOP** (■) button to cancel the setting and return to the [Home] screen.

- Press the **▶ OK** button.

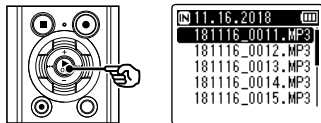

- Press the **+** or **-** button to select the desired file.
- Press the **▶ OK** button to start playback.

Erasing files/folders

This section describes how to erase a single unneeded file from a folder, erase all the files in the current folder at once, or erase a selected folder.

Erasing files

- 1 Select the file you want to erase (see P.23).
- 2 When the file display screen appears, press the **ERASE** button while the voice recorder is in stop mode.



- The voice recorder returns to the stopped mode if no operation is performed for 8 seconds.

- 3 Press the **+** or **-** button to select **[All in folder]** or **[One file]**.



- [All in folder]:**
Erases all the files saved in the same folder as the selected file.
- [One file]:**
Erases only the selected file.

- 4 Press the **▶ OK** button.

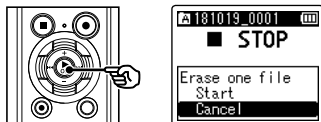

- 5 Press the **+** button to select **[Start]**.

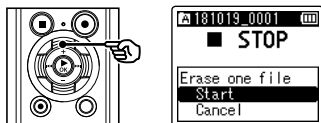

- 6 Press the **▶ OK** button.

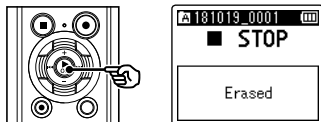

- **[Erasing!]** appears in the display, and the erasing process starts. **[Erased]** appears when the process has finished.

Erasing a folder

- 1 Select the folder you want to erase (see P.23).
- 2 In the folder display screen, press the ERASE button while the voice recorder is in stop mode.

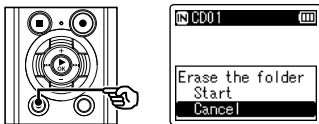

- The voice recorder returns to the stopped mode if no operation is performed for 8 seconds.

- 3 Press the + button to select [Start].

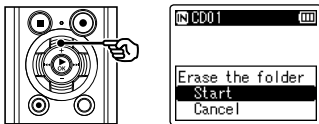

- 4 Press the ►OK button.

- [Erasing!] appears in the display, and the erasing process starts. [Erased] appears when the process has finished.

NOTE

- Files cannot be restored after being erased, so please check carefully before erasing a file.
- When there is a microSD in the voice recorder, be sure to check whether the recording media being erased is on the [Internal memory] or [microSD card] (see P.73).
- Locked files and read-only files cannot be erased (see P.57).
- The voice recorder's default [Recorder] folders ([FolderA] to [FolderE]) and [Music] folder cannot be erased.
- [Music] folder subfolders other than the [Music] can be erased.
- Files unrecognizable to the voice recorder will not be erased, nor will folders containing these files. The voice recorder must be connected to a PC to erase these files and folders.
- Before erasing a file or folder, charge or replace the battery to ensure it will not run out before the process has finished. Erasing processes can take over 10 seconds to complete. To prevent the risk of damage to data, never attempt to perform any of the following processes before an erasing process has finished :
 - Disconnecting the AC adapter
 - Removing the battery
 - Removing the microSD card (if the recording media has been set to [microSD card]).

Menu

Setting menu items

Basic operation

Menu items are arranged by tabs, with which you can quickly set desired items by selecting a tab and then moving to the desired item within the tab. Follow the steps below to set a menu item.

4

Setting menu items

- 1 During recording/playback or while the voice recorder is in stop mode, press the MENU/SCENE button.**

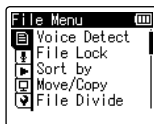
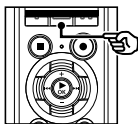

TIP

- Some menus contain items that can be set during recording/playback (P.56).

- 2 Press the + or – button to select the tab containing the item you want to set.**

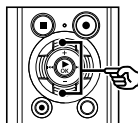

- Moving the cursor from one tab to another switches the displayed menu screen.

- 3 Press the ►OK button to move the cursor to the desired setting item.**

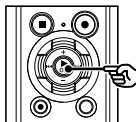

- You can also use the ►| button to perform this operation.

- 4 Press the + or – button to select the desired setting item.**

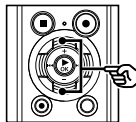

Setting menu items

Basic operation

5 Press the ►OK button.

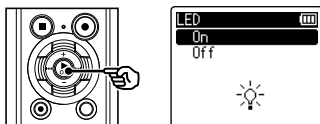

- The setting of the selected item is displayed.
- You can also use the ►► button to perform this operation.

6 Press the + or – button to change the setting.

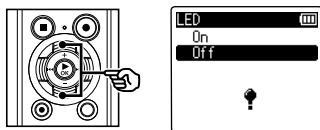

7 Press the ►OK button to finalize the setting.

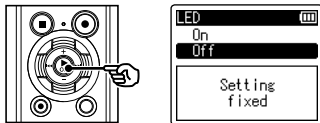

- A message indicating the setting has been entered appears.
- You can cancel the setting and return to the previous screen by pressing the ◀◀ button instead of the ►OK button.

8 Press the STOP (■) button to exit the menu screen.

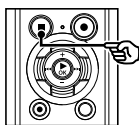

- When the menu screen is displayed during recording or playback, press the **MENU/SCENE** button to return to the previous screen without ending recording/playback.

NOTE

- For menu settings done while the voice recorder is in stop mode, the voice recorder exits the menu and returns to the stopped mode if no operation is performed for 3 minutes. The selected setting item is not changed in this case.
- For menu settings done during recording/playback, the voice recorder exits the menu if no operation is performed for 8 seconds.

Basic operation

■ Menu items that can be set during recording

- Rec Level
- Zoom Mic
- Low Cut Filter
- VCVA
- Backlight
- LED

■ Menu items that can be set during Playback

- Property
- Noise Cancel*1
- Voice Balancer*1
- Play Mode
- Equalizer*2
- Skip Space
- Backlight
- LED

*1 Function active only in **[Recorder]** mode.

*2 Function active only in **[Music]** mode.

Extracting the speaking portions of files of spoken-word content [Voice Detect]

The function extracts the speech portions of a voice file or a file being recorded by the voice recorder.

See “**Extracting speaking portions of files of spoken-word content [Voice Detect]**” (P.77) for more information.

Preventing accidental file erasure [File Lock]

With the file lock feature you can lock important files to prevent them being accidentally erased. Once locked, a file is not erased even if the operation for erasing all the files in its folder is performed (P.52).

1 Select the file you want to lock (P.23).

[Lock]:
File is locked.

[Unlock]:
File lock is canceled.

Sorting files [Sort by]

You can change the playback order of the files in a folder.

1 Press the + or – button to select [File name], [Date ascending] or [Date descending].

[File name]:
Automatically sorts the files by file name.

[Date ascending]:
Automatically sorts the files by date (recording time/date) from oldest to newest files.

[Date descending]:
Automatically sorts the files by date (recording time/date) from newest to oldest files.

2 Press the + or – button to select [Recorder] or [Music].

[Recorder]:
Sorts all the files in the [Recorder] folder.

[Music]:
Sorts all the files in the [Music] folder.

NOTE

- When [File name] is selected, files are listed in order of file name based on the first 20 characters of each name.

File menu [File Menu]

Moving/copying files [Move/Copy]

Files saved in the internal memory or on a microSD card can be moved or copied within memory.

See “**Moving/copying files [Move/Copy]**” (P.79) for the procedure.

Dividing files [File Divide]

Large files or files with long recording times can be divided for easier management and editing.

See “**Dividing a file [File Divide]**” (P.82) for the procedure.

Partially erasing files [Partial Erase]

You can erase unneeded parts of a file.

See “**Partially erasing files [Partial Erase]**” (P.84) for the procedure.

Trimming a file [Trimming]

A file can be trimmed down to just the required portion and then re-saved.

See “**Trimming a file [Trimming]**” (P.86) for the procedure.

! LS-P4 model only

Increasing the overall volume level of a file [Normalize]

Increase the overall volume level until the highest volume level of the recorded file becomes the no clipping (no distortion) threshold value and then save as a new file.

! LS-P4 model only

1 Press the + button to select [Start].

TIP

- The file is given the name “**File name_1**” after editing.

NOTE

- Only PCM or MP3 format files recorded on the voice recorder can be edited.
- The normalize effect may not be achieved for files such as the following.
 - Files originally recorded at a high volume level.
 - Files in which sudden loud sounds are recorded.
 - Files containing a large variation of volume levels.

Fading in/out audio at the beginning/end of a file [Fade in/out]

LS-P4 model only

You can apply fade in/out effect to the beginning/end of a file for approximately 1 second respectively and save the file as another file.

See “**Fading in/out audio at the beginning/end of a file [Fade in/out]**” (P.88) for the procedure.

Displaying file or folder information [Property]

You can display the information of a file or folder from a menu screen.

File information

1 Press the + or – button to switch the screen.

- Information is displayed for the items [Name], [Date], [Size], [Bit Rate]^{*1}, [Artist]^{*2} and [Album]^{*2}.

*1 If you selected a linear PCM or FLAC (LS-P4 model only) format file, the [Bit Rate] item displays the sampling frequency and bit count.

*2 If the file has no tag information, [UNKNOWN_ARTIST] and [UNKNOWN_ALBUM] are displayed.

Folder information

1 Press the + or – button to switch the screen.

- Information is displayed for the items [Name], [File] (the number of files) and [Folder] (the number of folders).
- The [Folder] item is not displayed in [Recorder] mode.
- Displayed numbers of files do not include files in formats that are unrecognizable to the voice recorder.

Recording menu [Rec Menu]

Selecting the recording level [Rec Level]

You can change the recording level (sensitivity) as needed for your recording application.

[High]:

The highest recording sensitivity. Suited to recording lectures, large conferences and other applications with distant or quiet sound sources.

[Middle]:

Suited to recording discussions and small-group meetings.

[Low]:

The lowest recording sensitivity. Suited to recording dictation.

[Manual]:

Lets you set the recording sensitivity manually, to any of 30 levels.

[Auto]:

The recording level always automatically changes according to the volume of the input sound. Suited to recording all sounds.

TIP

- To record the speaker's voice clearly, set [Rec Level] to [Low], and place the voice recorder's built-in microphone near the speaker's mouth (5 to 10 cm away).

NOTE

- When [Rec Level] is set to other than [Manual], the recording level is adjusted automatically but noise may be generated if an excessively loud sound is input.
- The [Rec Scene] setting automatically changes to [OFF] when [Rec Level] is set.

Adjusting the recording level

- Adjust the recording level by pressing the **▶▶** or **◀◀** button during recording or when recording is paused.

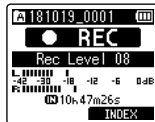
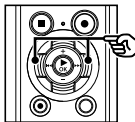

- Increasing the [Rec Level] number increases the recording level and extends the level meter indicator position.

NOTE

- If [OV] is displayed, the recorded audio will be distorted. Adjust the recording level so that [OV] is not displayed.
- [Rec Level] cannot be set during recording when [Rec Scene] is set.

Recording menu [Rec Menu]

Reducing clipping [Limiter]

Automatically reduce clipping caused by the input of excessively loud sounds during recording.

[Music]:

Select this setting for clarity of sound volume. This setting is suitable for music recordings.

[Voice]:

Select this setting to equalize the sound volume. The sound can be recorded at a predetermined volume to produce equalized recordings. This setting is suitable for voice recordings.

[Off]:

Use this position when adjusting the input levels without using the correction function.

NOTE

- This function is only available when [Rec Level] is set to [Manual] (P.60).
- If the sound input is too loud, noise may occur even if you set to [Music] or [Voice]. Also, in certain cases the **PEAK** indicator light, which indicates loud input, may not lit. To ensure successful recording, we recommend that you test the record function and volume before use.

Setting the recording mode [Rec Mode]

You can prioritize sound quality or recording time. Select the recording mode that best matches your recording application.

1 Press the + or – button to select the recording format.

[PCM]:

This is an uncompressed audio format which is used for music CDs etc.

[FLAC]*:

This is a losslessly compressed audio format. File size in this format is smaller than in the PCM format.

[MP3]:

This is a common lossy compressed audio format. File size in this format is the smallest.

* LS-P4 model only

2 Press the + or – button to select the recording rate.

[96.0kHz/24bit]	[PCM] [FLAC] ^{*1}
[88.2kHz/24bit]	[PCM] [FLAC] ^{*1}
[48.0kHz/24bit] ^{*1}	[PCM] [FLAC] ^{*1}
[48.0kHz/16bit]	[PCM] [FLAC] ^{*1}
[44.1kHz/24bit] ^{*1}	[PCM] [FLAC] ^{*1}
[44.1kHz/16bit]	[PCM] [FLAC] ^{*1}
[44.1kHz mono] ^{*2}	[PCM] [FLAC] ^{*1}
[320kbps]	[MP3]
[128kbps]	[MP3]
[64kbps mono] ^{*2}	[MP3]

*1 LS-P4 model only

*2 Mono recording

TIP

- Sound quality increases as the recording rate value increases.
- Setting a higher recording rate increases file size. Check that you have enough remaining memory before recording.
- To record conferences and presentations clearly, it is recommended to set [**Rec Mode**] to other than [**mono**].

NOTE

- When [**Rec Mode**] is set to stereo, recording with a connected mono microphone records on the left channel only.
 - The [**Rec Scene**] setting automatically changes to [**OFF**] when [**Rec Mode**] is set.
 - Seconds of the remaining recordable time is not displayed when [**FLAC**]* is set.
 - If you connect a Bluetooth® device to this recorder and start recording when [**FLAC**]* is set, the [**Rec Mode**] setting automatically changes to [**PCM**].
- * LS-P4 model only

Selecting microphone directivity [Zoom Mic]

The voice recorder's built-in stereo microphone provides directivity ranging from broad-coverage stereo recording to highly directional recording.

1 Press the + or – button to adjust the built-in stereo microphone's directivity.

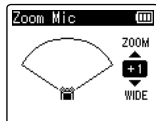
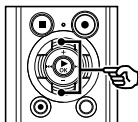

- The + button increases directivity.
 - The – button enables recordings with broader-coverage stereo.
 - Reducing directivity and broadening the sound pickup range gives recordings more of a stereo effect.
- The setting can be adjusted to between [–3] and [+6].

Recording menu [Rec Menu]

Zoom Mic function

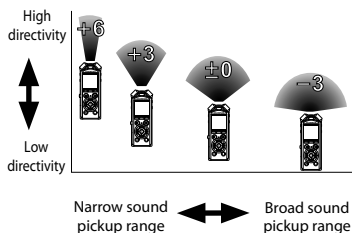

NOTE

- The [Zoom Mic] function has been set so as to optimize its performance when it is used with the voice recorder's built-in stereo microphone. Note that normal recording may no longer be possible when using a separately purchased microphone or when recording from another device using a connecting cord.
- Using the [Zoom Mic] function will make the battery deplete more quickly.
- The [Rec Scene] setting automatically changes to [OFF] when [Zoom Mic] is set. [Zoom Mic] cannot be set during recording when [Rec Scene] is set.

Reducing noise during recording [Low Cut Filter]

The voice recorder's low cut filter function lets you make recordings that reduce humming sounds from air-conditioners or low-frequency sounds from equipment such as projectors.

- [On]:
Turns the low cut filter On.
- [Off]:
Turns the low cut filter Off.

NOTE

- The [Rec Scene] setting automatically changes to [OFF] when [Low Cut Filter] is set. [Low Cut Filter] cannot be set during recording when [Rec Scene] is set.

Selecting the three microphones system [Mic Select]

You can select whether or not the built-in center microphone is to be turned on or off.

! LS-P4 model only

- [Central Mic On]:
Enables the built-in center microphone to record in three-microphone mode.
- [Central Mic Off]:
Disables the built-in center microphone to record with just the built-in stereo microphone.

Recording menu [Rec Menu]

NOTE

- The [Rec Scene] setting automatically changes to [OFF] when [Mic Select] is set.

Voice-activated recording function [VCVA]

4

Recording menu [Rec Menu]

The voice-activated recording function (VCVA) automatically starts recording when a sound louder than a preset voice activation level is detected, and automatically pauses recording when the sound volume level falls. Use this function to automatically omit unneeded quiet segments when recording (such as long silences during conferences), saving memory.

[On]:

Turns VCVA On. You can adjust the voice activation level used for VCVA.

[Off]:

Turns VCVA Off. Restores standard recording.

Adjusting the voice activation level for voice-activated recording

1 Press the REC (●) button to start recording.

- Recording pauses automatically about 1 second after the input sound becomes quieter than the set activation sensitivity. The blinking message [Standby] appears in the display. The recording indicator light becomes lit when recording is activated and flashes when recording is paused.

2 Press the ►►| or |◄◄ button to adjust the voice activation level.

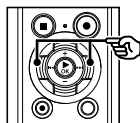

- a Voice activation level (moves left/right to match set level)
 - b Level meter (changes in proportion to recording sound volume)
- The setting can be adjusted to between [01] and [23].

TIP

- Increasing the setting number increases the VCVA activation sensitivity, enabling quieter sounds to activate the start of recording.
- Adjust the VCVA voice activation level to suit the recording conditions (to cope with high levels of surrounding noise or the like).
- To avoid recording mistake, it's recommended to perform a test recording beforehand to adjust the voice activation level.
- To change the recording level (☞ P.60) during VCVA recording in [Manual], press the **F1** button. The voice recorder changes to recording level adjustment mode. Press the **F1** button again to return to voice activation level adjustment mode.

NOTE

- The following settings automatically change to [OFF] when [VCVA] is set. [VCVA] cannot be set during recording when any of the following settings is set.
 - [Rec Scene] (☞ P.32)
 - [OVER DUB]* (☞ P.35)
 - [While recording] (☞ P.77)
 - [V-Sync. Rec] (☞ P.65)
- * LS-P4 model only

Voice sync recording function [V-Sync. Rec]

The voice sync recording function automatically starts recording when a sound louder than a preset voice sync recording level (detection level) is detected, and automatically stops recording when the sound volume level decreases. When copying music from another device connected to the voice recorder, use the voice sync recording function to detect the silent intervals between music tracks and save each track as a separate file.

[1 sec.], [2 sec.], [3 sec.], [5 sec.]:

Set the detection time. The voice recorder enters standby mode when the input (recording level) is below the preset level for at least the set detection time.

[Off]:

Recording is done normally.

Adjusting the voice sync level for voice sync recording

- Press the **REC** (●) button to prepare for recording.

Recording menu [Rec Menu]

- 2 Press the **▶▶** or **◀◀** button to adjust the voice sync level.**

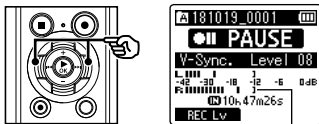

Voice sync level (moves left/right to match set level)

- The voice sync level can be adjusted to a setting between **[01]** and **[23]**.
- Increasing the setting number increases the activation sensitivity, enabling quieter sounds to activate the start of recording.

TIP

- To change the recording level (☞ P.60) during voice sync level adjustment in **[Manual]**, press the **F1** button. The voice recorder changes to recording level adjustment mode. Press the **F1** button again to return to voice sync level adjustment mode.

- 3 Press the **REC** (●) button again.**

- The blinking message **[Standby]** appears in the display, and the recording indicator light blinks.
- Recording starts automatically if the input is louder than the voice sync level.

TIP

- The voice recorder automatically ends recording and returns to recording standby mode when the input sound has been below the set detection time. Each time the voice recorder enters standby mode, the current file is closed. Recording continues in a new file the next time sound is detected.
- Press the **STOP** (■) button to end a voice sync recording session.

NOTE

- The following settings automatically change to **[OFF]** when **[V-Sync. Rec]** is set.
 - **[Rec Scene]** (☞ P.32)
 - **[OVER DUB]*** (☞ P.35)
 - **[While recording]** (☞ P.77)
 - **[VCVA]** (☞ P.64)
- * LS-P4 model only

Playback menu [Play Menu]

Skipping non-voice portions during playback [Voice Playback]

With the **[Voice Playback]** function you can only play the speaking portions of a recorded file of spoken-word content.

NOTE

- The speaking portions of the file must be extracted beforehand (☞ P.77).
- The **[Voice Playback]** function is only enabled in **[Recorder]** mode.

[On]:

Automatically skips the non-voice portions of the file and plays only the speaking portions.

[Off]:

The voice playback function is disabled.

Reducing noise during playback [Noise Cancel]

Use the **[Noise Cancel]** function to reduce noise when a recorded voice is difficult to discern.

[High][Low]:

Reduces surrounding noise, producing higher sound-quality playback.

[Off]:

The noise reduction function is disabled.

NOTE

- **[Noise Cancel]** is only enabled in **[Recorder]** mode.
- Using the **[Noise Cancel]** function will make the battery deplete more quickly.

Playback menu [Play Menu]

Adjusting low volume portions during playback [Voice Balancer]

Cuts low- and high-frequency components and compensates low-volume portions during playback.

Use it to make quiet parts of conversations or other recorded audio louder and clearer.

[On]:

Adjusts low-volume portions of audio files during playback, making them louder.

[Off]:

The voice balancer function is disabled.

NOTE

- **[Voice Balancer]** is only enabled in **[Recorder]** mode.
- Using the **[Voice Balancer]** function will make the battery deplete more quickly.

Selecting playback modes [Play Mode]

Several playback modes are available for different listening styles.

- 1 **Press the + or – button to select [Recorder] or [Music].**

When [Recorder] was selected

- 2 **Press the + or – button to select [File] or [Folder].**

[File]:

Stops playback after the current file has been played.

[Folder]:

Plays all the files in the current folder consecutively, stopping playback after the last file in the folder is played.

When [Music] was selected

- 2 **Press the + or – button to select [Playback Range], [Repeat] or [Random].**

[Playback Range]:

Lets you specify a range of files for playback.

[Repeat]:

Repeatedly plays the files in the set range.

[Random]:

Plays the files in the set range at random.

Playback menu [Play Menu]

3 Press the + or – button to select a setting.

When [Playback Range] was selected:
[File], [Folder], [All]:

Specify the range of files for playback.

When [Repeat] or [Random] was selected:

[On]:

The files in the specified playback range are played repeatedly or at random.

[Off]:

Cancels repeat playback and random playback.

NOTE

- When [Playback Range] is set to [File], [End] blinks in the display for 2 seconds after the last file in the folder has been played, then playback stops at the start position of the last file.
- When [Playback Range] is set to [Folder], [End] blinks in the display for 2 seconds after the last file in the folder has been played, then playback stops at the start position of the first file in the folder.
- When [Playback Range] is set to [All], after the last file in the current folder has been played, the first file in the next folder is being played. When playback reaches the end of the last file in the voice recorder, [End] blinks in the display for 2 seconds, then playback stops at the start position of the first file in the voice recorder.

Changing music sound quality [Equalizer]

The voice recorder's equalizer settings can be changed to change music sound quality as desired.

When [User] was selected

1 Press the ►►► button.

2 Press the ►►► or ◀◀◀ button to select a frequency band.

- You can set different levels for the [60 Hz], [250 Hz], [1 kHz], [4 kHz] and [12 kHz] frequency bands.

3 Press the + or – button to set a level.

- Levels can be set to values between [–6] and [+6], in 1 dB increments.
- Increasing a level setting emphasizes the corresponding frequency band.
- To change another frequency band, repeat Steps 2 and 3.

NOTE

- [Equalizer] function is only enabled in [Music] mode.

Setting a skip space [Skip Space]

The **[Skip Space]** function lets you skip a preset amount forward (forward skip) or backward (reverse skip) in a file during playback. It is handy for quickly moving the playback position, or for repeated playback of a short segment.

- 1 Press the **+** or **-** button to select **[Forward Skip]** or **[Reverse Skip]**.

[Forward Skip]:

Starts playback after moving the playback position forward by the set amount.

[Reverse Skip]:

Starts playback after moving the playback position backward by the set amount.

- 2 Press the **+** or **-** button to select a setting.

When **[Forward Skip]** was selected:

[File Skip], **[10 sec. Skip]**, **[30 sec. Skip]**,
[1 min. Skip], **[5 min. Skip]**, **[10 min. Skip]**

When **[Reverse Skip]** was selected:

[File Skip], **[1 sec. Skip]** to **[3 sec. Skip]**,
[5 sec. Skip], **[10 sec. Skip]**, **[30 sec. Skip]**,
[1 min. Skip], **[5 min. Skip]**

NOTE

- Forward/reverse skip operations over a skip space that contains an index mark/temp mark or the starting position of a file will stop at that mark or at the start position.

Forward/reverse skip playback

- 1 Press the **▶ OK** button to start playback.
 - 2 Press the **▶▶|** or **|◀◀** button during playback.
- Playback starts after skipping forward or backward by the set amount.

LCD/Sound menu [LCD/Sound Menu]

Setting the backlight [Backlight]

The display backlights are switched on for a preset amount of time when a button operation is performed.

[5 sec.], [10 sec.], [30 sec.], [1 min.]:

Set the amount of time that the backlight stays lit.

[Off]:

Disables the backlight.

Adjusting the contrast [Contrast]

You can adjust the contrast of the display to 12 different levels.

- The setting can be adjusted to between [01] to [12].

Setting the LED indicator light [LED]

You can set the LED indicator light to not become lit.

[On]:

LED indicator light is switched on.

[Off]:

LED indicator light stays off.

TIP

- Even if you set the [LED] setting to [Off], the LED indicator light will flash while files are being transferred between the voice recorder and a PC.

Turning beeping sound on/off [Beep]

The voice recorder makes beeping sounds when buttons are pressed, or to warn in case of operation errors. You can select whether the voice recorder makes these beeping sounds.

[On]:

Enables beeping sounds.

[Off]:

Disables beeping sounds.

Changing the display language [Language]

You can select the language used in the voice recorder's displays.

- [Čeština], [Dansk], [Deutsch], [English], [Español], [Français], [Italiano], [Nederlands], [Polski], [Русский], [Svenska], [繁體中文].

TIP

- The language selections vary depending on where the voice recorder was purchased.

LCD/Sound menu [LCD/Sound Menu]

Setting the voice guidance [Voice Guide]

This feature gives voice announcements of recorder operating conditions.

See “**Setting the voice guidance [Voice Guide]**” (P.89) for the procedure.

LS-P4 model only

Playing the beginning of files automatically [Intro Play]

Each time you select a file in the file list screen, the voice recorder can automatically play a few seconds of the beginning of the file. This function is convenient for searching for a file because it allows you to check the content of files.

LS-P4 model only

[3 sec.], [5 sec.], [10 sec.]:

Each time you select a file, the beginning part will be played automatically.

[Off]:

Turns [Intro Play] off.

Selecting the speaker output [Speaker]

You can set the built-in speaker to be On or Off when the earphones are not connected. When set to [Off], sound will not be output from the speaker even if the earphones are accidentally disconnected. Use this setting to prevent possible embarrassment on public transport.

[On]:

The voice recorder's playback sound is output from the earphones when the earphones are connected, or from the built-in speaker when the earphones are not connected.

[Off]:

The voice recorder's playback sound is not output from the built-in speaker even if the earphones are disconnected.

Device menu [Device Menu]

Selecting the recording media [Memory Select]

If a microSD card is inserted into the voice recorder, you can select whether to use the internal memory or the microSD card (see P.18).

[Internal memory]:

Uses on the internal memory on the voice recorder.

[microSD card]:

Uses on the microSD card.

Setting power save mode [Power Save]

The voice recorder automatically enters power save mode if the voice recorder is stopped for a set amount of time after it is turned on. Pressing any button releases power save mode.

[5 min.], [10 min.], [30 min.], [1 hr.]:

Select the desired amount of time.

[Off]:

Disables power save mode. Note that leaving the voice recorder On will quickly deplete the battery.

Setting the battery in use [Battery]

Set the battery type to match the battery you are using.

[Ni-MH]:

Select this setting when using an Olympus Ni-MH rechargeable battery (model BR404).

[Alkaline]:

Select this setting when using an alkaline dry cell battery.

Setting the time/date [Time & Date]

If you set the date and time, you will be able to check when a file was recorded in the information for each file accessed from [Property] of the menu.

- 1 Press the **▶▶▶** or **◀◀◀** button to select the desired setting item.

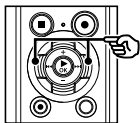

- 2 Press the **+** or **-** button to change the number.

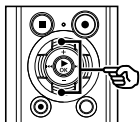

- To change the setting of another item, press the **▶▶▶** or **◀◀◀** button to move the blinking cursor, then press the **+** or **-** button to change the number.

- 3 Press the **▶OK** button to finalize the setting.

TIP

- When setting the hour or minute, each time you press the **F2** button the display changes between the AM/PM and 24-hour clock formats.

Example: 10:38 PM

10:38 PM
(default format) ←→ 22:38

- When setting the year, month or date, each time you press the **F2** button the display order used for the date changes.

Example: March 24, 2018

3M 24D 2018Y
(default format)

↓
24D 3M 2018Y

↓
2018Y 3M 24D

NOTE

- If the batteries are removed from the voice recorder, the [Time & Date] screen is displayed automatically when the power is turned on.
- Even if the voice recorder is not used for a long period of time, when the battery is used up, the date and time must be re-entered.

Connecting a Bluetooth® device [Bluetooth]

This function is compatible with Bluetooth® Ver. 2.1+EDR and allows you to connect the voice recorder to a device that is compatible with the same standard.

See “**Before using the Bluetooth® function**” (P.95) for details.

 **LS-P4 model only**

Setting the USB connection [USB Settings]

The [PC] setting lets you connect the voice recorder to a PC to transfer files. The [AC Adapter] setting lets you connect the voice recorder to a USB-connection AC adapter (model A514; optional) or a PC to charge the rechargeable battery. You can change the USB class setting as required by different USB applications.

See “**Setting the USB connection [USB Settings]**” (P.91) for the procedure.

Restoring the default settings [Reset Settings]

The [Reset Settings] function restores all the voice recorder's functions to their initial (factory default) settings. Time setting and file number will remain the same.

1 Press the + button to select [Start].

Rec Menu:

Rec Level: Manual
Limiter: Music
Rec Mode: PCM: 44.1kHz/16bit
Zoom Mic: Off
Low Cut Filter: Off
Mic Select³: Central Mic On
VCVA: Off
V-Sync. Rec: Off
Rec Scene: Off

Play Menu:

Voice Playback¹: Off
Noise Cancel¹: Off
Voice Balancer¹: Off
Play Mode:
Recorder:
Playback Range / File
Music:
Playback Range / Folder
Repeat / Off
Random / Off
Equalizer²: Off
Skip Space:
Forward Skip: File Skip
Reverse Skip: File Skip

LCD/Sound Menu:

Backlight: 10 sec.
Contrast: Level 06
LED: On
Beep: On
Language: English
Voice Guide^{*3}:
 On/Off: On
 Speed: 3
 Volume: 3
Intro Play^{*3}: Off
Speaker: On

Device Menu:

Memory Select: Internal memory
Power Save: 10 min.
Battery: Ni-MH
USB Settings:
 USB Connection: PC
 USB Class: Storage Class

- *1 Function active only in [Recorder] mode.
- *2 Function active only in [Music] mode.
- *3 LS-P4 model only

Formatting a recording media

[Format]

Formatting a recording media erases all existing files saved on it. Be sure to transfer all important files to a PC before formatting.

See "**Formatting recording media [Format]**" (P.93) for the procedure.

Checking recording media

information [Memory Info.]

You can display the capacity and remaining memory space of the recording media from a menu screen.

NOTE

- Some recording media memory capacity is used as a management area, so the actual usable capacity will always be slightly less than the displayed capacity.

Checking voice recorder

information [System Info.]

You can display voice recorder information from a menu screen.

- The voice recorder's [Model], [Version] (system version) and [Serial No.] information is displayed.

Extracting the speaking portions of files of spoken-word content [Voice Detect]

The function extracts the speech portions of a voice file or a file being recorded by the voice recorder.

NOTE

- The [Voice Detect] function can only be used in [Recorder] mode.
- To extract the speech portion from saved files, select a folder from [F1] to [F6] in the [Recorder] folder beforehand.

- 1 Press the MENU/SCENE button while the voice recorder is in stop mode.
- 2 Press the ►OK button to move the cursor into the list of setting items.
- 3 Press the ►OK button.
- 4 Press the + or - button to select [Select a file] or [While recording].

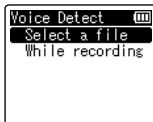
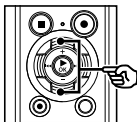

[Select a file]:

Select a file for which you want to extract the speech portion.

[While recording]:

Extract the speech portion while recording.

- 5 Press the ►OK button to move to the respective setting.

When [Select a file] is selected

- 1 Press the + or - button to select the desired file in which you want to detect voice.

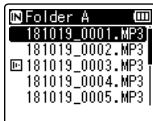

- 2 Press the ►OK button.
- The progress of the operation is shown as a percentage in the display.
 - [Voice Detection completed] appears when the process has finished.

Extracting the speaking portions of files of spoken-word content [Voice Detect]

When [While recording] is selected

- 1 Press the + or – button to select [On] or [Off].



[On]:

Extract the speech portion while recording.

[Off]:

Restores standard recording.

- 2 Press the ►OK button.
- [Setting fixed] appears when the process has finished.

6 Press the STOP (■) button to exit the menu screen.

TIP

- When the voice detection process has finished, the [Voice Playback] item in the [Play Menu] is set to [On] (☞ P.67).

NOTE

- The message [No file] appears if you select a folder that doesn't contain a saved file. You must select a folder containing a file before you can perform the process.
 - The voice recorder may not be able to properly extract non-silent portions from files of non-spoken word content such as recorded musical performances.
 - The voice recorder may not be able to properly extract speaking portions when they were low in volume when recorded (level meter readout of -12 dB or less), or due to surrounding noise.
 - The time needed for the extraction process will increase in proportion to the size of the recorded file. Before starting extraction, it's recommended to charge or replace the battery to ensure it will not run out before the process has finished.
 - Using the [While recording] function will make the battery deplete more quickly.
 - [While recording] function is only available when [Rec Mode] is set to [MP3] (☞ P.61).
 - The following functions are disabled when using the [While recording] function:
 - [Rec Scene] (☞ P.32)
 - [OVER DUB]* (☞ P.35)
 - [VCVA] (☞ P.64)
 - [V-Sync. Rec] (☞ P.65)
- * LS-P4 model only

Moving/copying files [Move/Copy]

Files saved in the internal memory or on a microSD card can be moved or copied within memory.

- 1 Before performing the move/copy operation, first select the folder containing the file you want to move or copy (see P.23).**
- 2 Press the MENU/SCENE button while the voice recorder is in stop mode.**
- 3 Press the ► OK button to move the cursor into the list of setting items.**
- 4 Press the + or – button to select [Move/Copy].**
- 5 Press the ► OK button.**
- 6 Press the + or – button to select the desired file movement/copying method.**

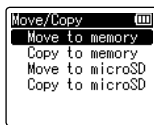
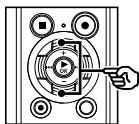

[Move to memory]:

Moves one or more files saved in the internal memory or inserted microSD card to a different folder in the internal memory.

[Copy to memory]:

Copies one or more files saved in the internal memory or inserted microSD card to a different folder in the internal memory.

[Move to microSD]:

Moves one or more files saved in the internal memory or inserted microSD card to a different folder in the microSD card.

[Copy to microSD]:

Copies one or more files saved in the internal memory or inserted microSD card to a different folder in the microSD card.

- 7 Press the ► OK button.**
- 8 Press the + or – button to select the number of files to move or copy.**

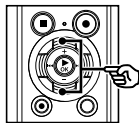

[One file]:

Selects only the specified file.

[Selected files]:

Selects multiple files.

[All files]:

Selects all the files in the folder.

Moving/copying files [Move/Copy]

- 9 Press the **▶OK** button to continue to the next setting.

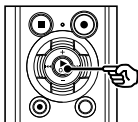

- ② Repeat Step ① to select all the files you want to move or copy, then press the **F2** button.

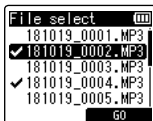

4

When [One file] was selected

- ① Press the **+** or **-** button to select the file to move or copy, then press the **▶OK** button.

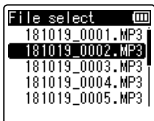

When [All files] was selected

All the files in the current folder are selected automatically, and the display switches to the [Destination] screen.

- 10 Press the **+**, **-**, **▶▶** or **◀◀** button to select the folder to move or copy the files to.

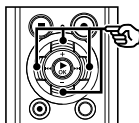

When [Selected files] was selected

- ① Press the **+** or **-** button to select a file to move or copy, then press the **▶OK** button.



TIP

- Files cannot be moved or copied directly within the [Recorder] folder. Press the **▶▶** or **◀◀** button to select a folder from **F1** to **F4** folder in the [Recorder] folder.

TIP

- You can deselect a previously selected file by selecting it and pressing the **▶OK** button again.

11 Press the F2 button.

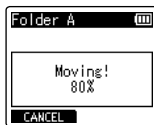

- The progress of the operation is shown as a percentage in the display.
- **[File move completed]** or **[File copy completed]** appears when the process has finished.

TIP

- Locked files (P.57) remain locked after being moved or copied.

NOTE

- Files cannot be copied if there is insufficient remaining memory.
- Files cannot be moved or copied if there are over 200 files.
- To prevent the risk of data damage, never remove the battery while moving or copying a file.
- Files cannot be moved or copied within the same folder.
- When a file moving or copying process is canceled before completion, the files that completed the process will have been moved or copied, and process is canceled for the other files.

Dividing files [File Divide]

Large files or files with long recording times can be divided for easier management and editing.

NOTE

- Only PCM or MP3 format files recorded on the voice recorder can be divided.

- 1 Before performing the file dividing operation, first select the file you want to divide (☞ P.23).
- 2 Press the MENU/SCENE button while the voice recorder is in stop mode.
- 3 Press the ►OK button to move the cursor into the list of setting items.
- 4 Press the + or – button to select [File Divide].
- 5 Press the ►OK button.
- 6 Press the ►OK button and play the file to the desired division point (☞ P.39).

TIP

- Writing an index mark/temp mark at the division point beforehand is handy (☞ P.48).

- 7 Press the F2 button at the desired division point.

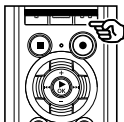

- 8 Press the + button to select [Start].

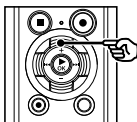

- 9 Press the ►OK button.

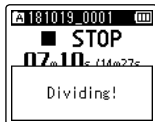
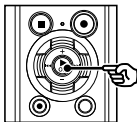

- 10 Press the STOP (■) button to exit the menu screen.

- [Dividing!] appears in the display, and the file dividing process starts. [File divide completed] appears when the process has finished.

Dividing files [File Divide]

TIP

- After dividing a file, the first half of the file is given the name "**File name_1**" and the second half "**File name_2**".

NOTE

- [**File Divide**] can be performed only when the file list is displayed.
- Files cannot be divided if there are 200 files in the folder.
- Locked files (Ⓜ P.57) cannot be divided.
- It may not be possible to divide some MP3 or PCM files with extremely short recording times.
- To prevent the risk of data damage, never remove the battery while dividing a file.

Partially erasing files [Partial Erase]

You can erase unneeded parts of a file.

NOTE

- Only PCM-format file recorded on the voice recorder can be erased.

1 Before performing the file erasing operation, first select the file you want to erase (☞ P.23).

2 Press the MENU/SCENE button while the voice recorder is in stop mode.

3 Press the ►OK button to move the cursor into the list of setting items.

4 Press the + or – button to select [Partial Erase].

5 Press the ►OK button.

6 Press the ►OK button to play the file to the desired erasing point (☞ P.39).

- You can change the playback speed (☞ P.44), and fast-forward/rewind (☞ P.40).

7 Press the F2 button at the partial erase start position.



TIP

- Playback continues while [Start] position is set and as with usual playback, changing the playback speed and fast-forward/rewind can be performed and you can quickly advance to the [End] position.
- When the end of the file is reached while the [End] position is not set, that position becomes the end position of erase.
- Writing an index mark/temp mark at the start point and end point beforehand is handy (☞ P.48).

8 Press the F2 button again at the position where you want to end partial erase.

Partially erasing files [Partial Erase]

- 9 Press the + button to select [Start].

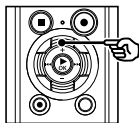

- 10 Press the ► OK button.

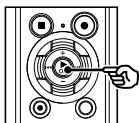

- [Partial erasing!] appears in the display, and the file erasing process starts.
- [Partial erase completed] appears when the process has finished.

- 11 Press the STOP (■) button to exit the menu screen.

NOTE

- Files cannot be restored after being erased, so please check carefully before erasing a file.
- Locked files and read-only files cannot be erased (refer P.57).
- Before erasing a file or folder, charge or replace the battery to ensure it will not run out before the process has finished. Erasing processes can take over 10 seconds to complete. To prevent the risk of damage to data, never attempt to perform any of the following processes before an erasing process has finished:
 - Disconnecting the AC adapter
 - Removing the battery
 - Removing the microSD card (if the recording media has been set to [microSD card]).

Trimming a file [Trimming]

A file can be trimmed down to just the required portion and then re-saved.

! LS-P4 model only

NOTE

- Only PCM-format file recorded on the voice recorder can be trimmed.

4

Trimming a file [Trimming]

- 1 Before performing the file trimming operation, first select the file you want to trim (P.23).**
- 2 Press the MENU/SCENE button while the voice recorder is in stop mode.**
- 3 Press the ►OK button to move the cursor into the list of setting items.**
- 4 Press the + or – button to select [Trimming].**
- 5 Press the ►OK button.**
- 6 Press the ►OK button to play the file to the desired trimming point (P.39).**
 - You can change the playback speed (P.44), and fast-forward/rewind (P.40).

- 7 Press the F2 button at the position where you want to start trimming.**



TIP

- Playback continues while [Start] position is set and as with usual playback, changing the playback speed and fast-forward/rewind can be performed and you can quickly advance to the [End] position.
 - When the end of the file is reached while the [End] position is not set, that position becomes the end position of trimming.
 - Writing an index mark/temp mark at the start point and end point beforehand is handy (P.48).
- 8 Press the F2 button again at the position where you want to end trimming.**

Trimming a file [Trimming]

- 9 Press the + button to select [Start].

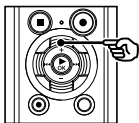

- 10 Press the ► OK button.

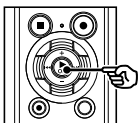

- [Trimming!] appears in the display, and the file trimming process starts. [Trimming completed] appears when the process has finished.

- 11 Press the STOP (■) button to exit the menu screen.

NOTE

- If a file has an extremely short recording time, it may not be trimmed even if it is a PCM file.
- Locked files and read-only files cannot be trimmed (refer P.57).
- Before trimming a file, charge or replace the battery to ensure it will not run out before the process has finished. Trimming processes can take over 10 seconds to complete. To prevent the risk of damage to data, never attempt to perform any of the following processes before a trimming process has finished:
 - Disconnecting the AC adapter
 - Removing the battery
 - Removing the microSD card (if the recording media has been set to [microSD card]).

Fading in/out audio at the beginning/end of a file [Fade in/out]

You can apply fade in/out effect to the beginning/end of a file for approximately 1 second respectively and save the file as another file.

LS-P4 model only

NOTE

- Only PCM format files recorded with this recorder can be faded in/out.

4

Fading in/out audio at the beginning/end of a file [Fade in/out]

- 1 Select a file you want to apply fade in/out effect to (see P.23).
- 2 Press the **MENU/SCENE** button while the voice recorder is in stop mode.
- 3 Press the **▶OK** button to move the cursor into the list of setting items.
- 4 Press the **+** or **-** button to select [Fade in/out].
- 5 Press the **▶OK** button.
- 6 Press the **+** button to select [Start].

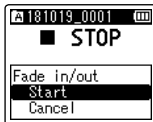
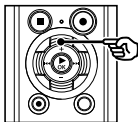

- 7 Press the **▶OK** button.

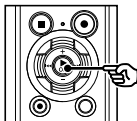

- [Fading in/out!] is displayed on the screen, and the audio is faded in and out. The process is finished when [Faded in/out] is displayed.

- 8 Press the **STOP** (■) button to exit the menu screen.

TIP

- The file is given the name "File name_1" after fade in/out effect is applied.

Setting the voice guidance [Voice Guide]

This feature gives voice announcements of recorder operating conditions. You can set voice announcement On/Off, speed and volume.

LS-P4 model only

- 1 Press the **MENU/SCENE** button while the voice recorder is in stop mode.
- 2 Press the **+ or -** button to select the **[LCD/Sound]** tab.
- 3 Press the **▶OK** button to move the cursor into the list of setting items.
- 4 Press the **+ or -** button to select **[Voice Guide]**.
- 5 Press the **▶OK** button.
- 6 Press the **+ or -** button to select **[On/Off]**, **[Speed]** or **[Volume]**.

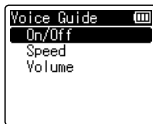
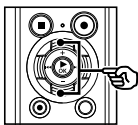

[On/Off]:
Switches voice guidance On/Off.

[Speed]:
Sets the voice guidance speed.

[Volume]:
Sets the voice guidance volume.

- 7 Press the **▶OK** button to move to the respective setting.

When [On/Off] was selected

- 1 Press the **+ or -** button to select **[On]** or **[Off]**.

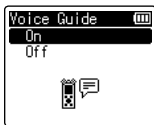

[On]:
Voice guidance will be enabled.

[Off]:
Voice guidance will be canceled.

- 2 Press the **▶OK** button to exit the selection screen.

When [Speed] was selected

- 1 Press the **+ or -** button to select the voice speed.

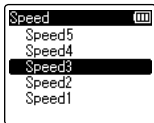

[Speed1] to [Speed5]:
The greater the number, the faster the speed.

- 2 Press the **▶OK** button to exit the selection screen.

Setting the voice guidance [Voice Guide]

When [Volume] was selected

- ① Press the + or – button to select the voice volume.

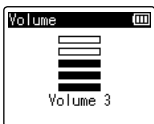

[Volume1] to [Volume5]:

The greater the number, the louder the beep sound.

- ② Press the ►OK button to exit the selection screen.

8 Press the STOP (■) button to exit the menu screen.

NOTE

- During playback of a file, the [Speed] setting of [Voice Guide] is disabled.

Setting the USB connection [USB Settings]

The [PC] setting lets you connect the voice recorder to a PC to transfer files. The [AC Adapter] setting lets you connect the voice recorder to a USB-connection AC adapter (model A514; optional) or a PC to charge the rechargeable battery. You can change the USB class setting as required by different USB applications.

- 1 Press the MENU/SCENE button while the voice recorder is in stop mode.**
- 2 Press the + or – button to select the [Device Menu] tab.**
- 3 Press the ►OK button to move the cursor into the list of setting items.**
- 4 Press the + or – button to select [USB Settings].**
- 5 Press the ►OK button.**
- 6 Press the + or – button to select [USB Connection] or [USB Class].**

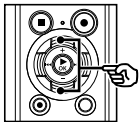

[USB Connection]:

Used to set connection to a PC.

[USB Class]:

Used to set the USB class.

- 7 Press the ►OK button.**

When [USB Connection] was selected

➤ Go to Step 8

When [USB Class] was selected

➤ Go to Step 10

TIP

- If the voice recorder is not recognized by the PC as an external memory device, select [Storage Class] for [USB Class].
- If [AC Adapter] is selected for [USB Connection], the voice recorder will not be recognized if connected to a PC.

Setting the USB connection [USB Settings]

When [USB Connection] was selected

- 8** Press the + or – button to select a setting.

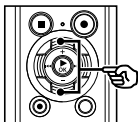

[PC]:

Select to connect the voice recorder to a PC. The voice recorder will be connected as a storage or composite device.

[AC Adapter]:

Select to charge the rechargeable battery from a PC, or to connect the voice recorder to an AC adapter (model A514; optional).

[Optional]:

Select to confirm the connection method whenever making a USB connection.

- 9** Press the ►OK button, and go to Step 12.

When [USB Class] was selected

- 10** Press the + or – button to select a setting.

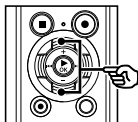

[Storage Class]:

Select to have the voice recorder recognized as an external memory device by a connected PC.

[Composite]:

Select to have the voice recorder recognized as an external memory device by a connected PC, and to use the voice recorder as a USB speaker/microphone.

- 11** Press the ►OK button.
- 12** Press the STOP (■) button to exit the menu screen.

Formatting recording media [Format]

Formatting a recording media erases all existing files saved on it. Be sure to transfer all important files to a PC before formatting.

- 1 Press the **MENU/SCENE** button while the voice recorder is in stop mode.
- 2 Press the **+** or **-** button to select the **[Device Menu]** tab.
- 3 Press the **▶OK** button to move the cursor into the list of setting items.
- 4 Press the **+** or **-** button to select **[Format]**.
- 5 Press the **▶OK** button.
- 6 Press the **+** or **-** button to select the recording media to be formatted.
- 7 Press the **▶OK** button.
- 8 Press the **+** button to select **[Start]**.

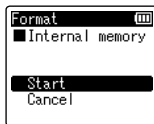
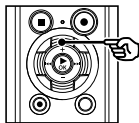

- 9 Press the **▶OK** button.

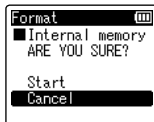
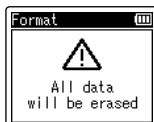
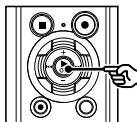

- 10 Press the **+** button to select **[Start]** again.
- 11 Press the **▶OK** button.

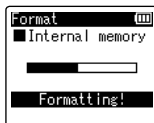
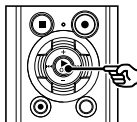

- **[Formatting!]** appears, and formatting starts.
- **[Format done]** appears when the process has finished.

TIP

- To reset all the voice recorder's settings to their default values, use the **[Reset Settings]** operation (P.75).

NOTE

- Never format the voice recorder from a PC.
- Formatting erases all the existing data, including locked files and read-only files.
- If there is a microSD card in the voice recorder, make sure **[Internal memory]** or **[microSD card]** has been correctly selected as the recording media to erase (☞ P.73).
- Before formatting, charge or replace the battery to ensure it will not run out before the process has finished. The formatting process can sometimes take over 10 seconds to complete. To prevent the risk of damage to data, never attempt to perform any of the following processes before a formatting process has finished:
 - Disconnecting the USB-connection AC adapter
 - Removing the battery
 - Removing the microSD card (if the recording media has been set to **[microSD card]**)
- Even when formatting or erasing (☞ P.52) is performed, only the file management information of the internal memory and/or microSD card is updated and the recorded data is not completely erased. When disposing of a microSD card, be sure to destroy the card, format the card and record silence until the recording time runs out, or perform a similar operation in order to prevent the leakage of personal information.

Bluetooth® function

Before using the Bluetooth® function

LS-P4 model only

This function is compatible with Bluetooth® Ver. 2.1+EDR and allows you to connect the voice recorder to a device that is compatible with the same standard.

If you use Bluetooth® compatible earphones, you can use the voice recorder freely within the range that a signal can be received without a troublesome cable connected.

Radio signals extend a certain range and can penetrate obstacles (wood, glass, etc.), thus even if the voice recorder is placed another room, connection is possible.

Furthermore, if you use a special application on your smartphone, you can operate (record/stop) the voice recorder at a distance as long as you are within the range that a signal can be received. For details, see our website.

What can you do with the Bluetooth® function?

- You can use Bluetooth® compatible earphones and other devices wirelessly.
- You can use a smartphone to operate (record/stop) the voice recorder*.
- * To use this function, a special smartphone application needs to be installed.



NOTE

- The Bluetooth® function of the voice recorder is designed to be used in the following regions.

America: United states, Canada

Europe: Austria, Belgium, Bulgaria, Cyprus, Czech Republic, Denmark, Estonia, Finland, France, Germany, Greece, Hungary, Ireland, Italy, Latvia, Lithuania, Luxembourg, Malta, Netherlands, Poland, Portugal, Romania, Slovakia, Slovenia, Spain, Sweden, United Kingdom, Iceland, Liechtenstein, Norway, Switzerland, Croatia, Turkey

Oceania: Australia, New Zealand

Before using the Bluetooth® function

Do not use the Bluetooth® function of the device in regions other than those mentioned above. Also do not use the Bluetooth® function in other than the country or region of purchase.

Using the function could violate the radio signal restrictions in that country. We will assume no responsibility whatsoever for the use of this technology.

- Communication may be affected if there is reinforced structures, metal or concrete between the voice recorder and smartphone.
- Do not use the Bluetooth® function of the voice recorder in a hospital and airplane where its use is prohibited.
- Near a microwave, cordless telephone set, or device that uses the 2.4GHz frequency band, if the voice recorder is used at the same time with such a device, communication performance may be affected. When using the voice recorder, keep a sufficient distance away from such devices.
- To the extent possible, try not to use the voice recorder near mobile phones, televisions, or radios.
 - Mobile phones, PHS, TV sets, and radios use different frequencies than the voice recorder but electromagnetic waves generated from Bluetooth® devices including this voice recorder could generate noise in audio or video images.
- When using the Bluetooth® function, battery life is consumed quickly. Therefore, when using a Bluetooth® connection we recommend using a separately sold AC adapter.
- The voice recorder does not guarantee connection or operation with all Bluetooth®-compatible devices.
- We will assume no responsibility for any loss of data resulting from the use of the Bluetooth® function.

Notes on security when using Bluetooth® devices

- With a Bluetooth® connection, information is exchanged wirelessly between a smartphone and the voice recorder and as long as radio signals reach the unit, flexible connection is possible.
However, because radio signals can penetrate through obstacles (wood, glass, etc.), if there is no security-related setting, the following problems could occur.
 - A malicious third party intentionally intercepts radio signals to spy on communication content.
 - Unauthorized intrusion causes the leaking of personal information.
 - Intercepted communication contents are rewritten and transmitted.
 - Destructive computer viruses are released that can destroy data or systems.
- When you are not using the Bluetooth® function, disconnect the connection.
- Should a problem occur for an inevitable reason due to the specifications of the Bluetooth® connection, we assume no responsibility whatsoever for any damage incurred.

Before using the Bluetooth® function

About OLYMPUS Audio Controller BT



The OLYMPUS Audio Controller BT application for smartphones is required to use your smartphone to operate the voice recorder from a distance.

How to obtain the application

Supported OS (as of September 2017)

- For Android™: Android 4.0 to 7.1

Use the following method to obtain the application.

1 Connect your smartphone to the network.

2 Search for the application.

Using “Google Play™ (formerly called Android Market™)”, search for “OLYMPUS Audio Controller BT”.

3 Select “OLYMPUS Audio Controller BT” and download and install.

- An  icon is added to the smartphone apps menu.

What the application can do

Installing the application on your smartphone allows you to:

Use your smartphone to operate the voice recorder:

Use the Bluetooth® function to operate the voice recorder (recording, stop) from a distance.

NOTE

- For details about the application, see our webpage.
- When you download the application using a mobile phone line such as 3G, depending on your particular contract, you may incur packet communication fees.

Connecting/disconnecting a Bluetooth® device

Connecting a Bluetooth® device

This function is compatible with Bluetooth® Ver. 2.1+EDR and allows you to connect the voice recorder to a device that is compatible with the same standard. A wireless connection enables you to use earphones and other compatible devices freely within a certain range.

NOTE

- Check that there is sufficient battery life. Replace or charge the battery if needed (☞ P.9, P.12).
- Check that the Bluetooth® indicator is off (☞ P.5).
- Turn on the power of the device to be connected and check that there is sufficient battery power.
- Place the voice recorder and device to be connected within 1 m of each other.

TIP

- There are the following two ways to connect a Bluetooth® device.
[Pairing]:
Use this method when connecting a device that is to be used for the first time or when the connection settings have been deleted.
[Connection] (☞ P.100):
Use this method when connecting a Bluetooth® device for which the information is registered*.
* The pairing information has been saved to both devices.

Connecting using [Pairing]

Use this method when connecting a device that is to be used for the first time or when the connection settings have been deleted.

- 1 Switch to pairing mode on the device to be connected.**
 - For details on pairing mode, see the user's manual of the device to be used.
- 2 Press the MENU/SCENE button while the voice recorder is in stop mode.**
- 3 Press the + or – button to select [Device Menu] tab.**
- 4 Press the ►OK button to move the cursor into the list of setting items.**
- 5 Press the + or – button to select [Bluetooth].**

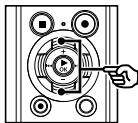

- 6 Press the ►OK button.**

Connecting/disconnecting a Bluetooth® device

- 7** Press the **+ or –** button to select **[Pairing]**.

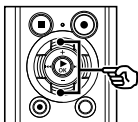

- 8** Press the **▶ OK** button.

- A search is performed for Bluetooth® devices that can be connected.
- It may take a while for the device to be connected to appear.

- 9** Press the **+ or –** button to select the device to be connected.

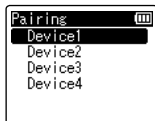
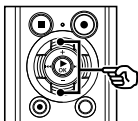

- 10** Press the **▶ OK** button.

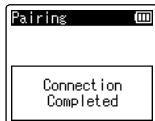
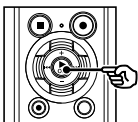

- **[Connecting!]** appears in the display, and the connecting process starts. **[Connection Completed]** appears when the process has finished.
- The Bluetooth® indicator on the screen lights and you become able to use the connected device.

- 11** Press the **STOP (■)** button to exit the menu screen.

■ About pairing

Registering a device pair when connecting with a Bluetooth® device is called pairing. Once pairing is complete, the necessary information is stored on both devices and you can subsequently connect by selecting the device from the list without having to perform pairing again.

Pairing will need to be performed again in the following cases.

- When the information for pairing with the voice recorder has been deleted on the Bluetooth® compatible device to be connected.
- When **[Reset Settings]** item of the voice recorder was executed to restore the factory default settings (see P.75).
- When the pairing information was deleted by a means other than the above.

Connecting/disconnecting a Bluetooth® device

Connecting using [Connection]

Use this method when switching the connection to another Bluetooth® device*.

* The pairing information has been saved to both devices.

- 1 Switch to pairing mode on the device to be connected.**
 - For details on pairing mode, see the user's manual of the device to be used.
- 2 Press the MENU/SCENE button while the voice recorder is in stop mode.**
- 3 Press the + or – button to select [Device Menu] tab.**
- 4 Press the ►OK button to move the cursor into the list of setting items.**
- 5 Press the + or – button to select [Bluetooth].**
- 6 Press the ►OK button.**
- 7 Press the + or – button to select [Connection].**

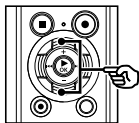

- 8 Press the ►OK button.**

- The name of the Bluetooth® device connected with the voice recorder up until now is displayed in the list.

- 9 Press the + or – button to select the device to be connected.**

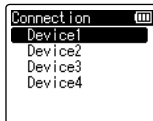
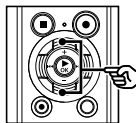

- Press the ►►I button to confirm the name and address of the selected Bluetooth® device. Press the ◀◀ button to return to the previous screen.



- 10 Press the ►OK button.**

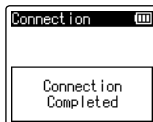
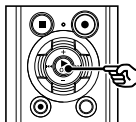

Connecting/disconnecting a Bluetooth® device

- **[Connecting!]** appears in the display, and the connecting process starts. **[Connection Completed]** appears when the process has finished.
- The Bluetooth® indicator on the screen lights and you become able to use the connected device.

11 Press the **STOP** (■) button to exit the menu screen.

NOTE

- Recording, playback, and other operations are not possible during the pairing process.
- Only one Bluetooth® device can be connected by performing pairing setting once. Multiple devices cannot be paired simultaneously. Configure the connection settings separately for each device.
- Only one device can be connected at a time.
- If an operation such as turning the power off is performed after pairing with a Bluetooth® device completes, the Bluetooth® connection will be disconnected. To connect again, perform this **[Connection]** operation.
- If the Bluetooth® connection is disconnected from the Bluetooth® device, the Bluetooth® function of the voice recorder is turned off automatically.
- If communication become unstable after the connecting is completed, the voice recorder may enter the connection wait state.
- If the Bluetooth® connection wait state is entered while recording or playback is in progress, the recording or playback operation is interrupted. Check the status of the voice recorder while recording or playback is in progress.
- If Bluetooth® is disconnected while recording or playback is in progress, the recording or playback operation stops.

Connecting/disconnecting a Bluetooth® device

Disconnecting the connection with a Bluetooth® device

Disconnecting the connection using [Disconnection]

- 1 Press the **MENU/SCENE** button while the voice recorder is in stop mode.
- 2 Press the **+** or **-** button to select [Device Menu] tab.
- 3 Press the **▶OK** button to move the cursor into the list of setting items.
- 4 Press the **+** or **-** button to select [Bluetooth].
- 5 Press the **▶OK** button.
- 6 Press the **+** or **-** button to select [Disconnection].

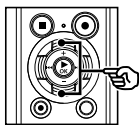

- 7 Press the **▶OK** button.

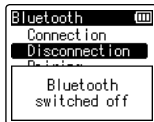
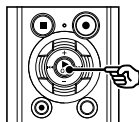

- [Terminating Bluetooth] appears in the display, and the disconnecting process starts. [Bluetooth switched off] appears when the process has finished.
 - The Bluetooth® indicator on the screen turns off.
- 8 Press the **STOP** (■) button to exit the menu screen.

Use with a PC

When connecting the voice recorder to a PC you can do the following:

- You can enjoy MP3 or linear PCM (WAV) format files saved on your PC, or FLAC* format music files downloaded from high-resolution distribution site.
- Use the voice recorder as external storage to save or load data to/from your PC (E8 P.108).

* LS-P4 model only

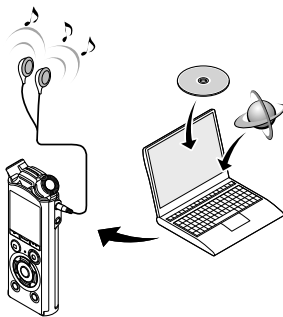

- The earphones are optional

PC operating environment

The requirements shown are the operating environments needed for using a USB connection to save files recorded by the voice recorder on a PC.

Windows

Operating system: Microsoft Windows 7/8/8.1/10 standard installation

PC: Windows PC with at least one available USB port

Macintosh

Operating system: Mac OS X 10.8 to macOS Sierra 10.12 standard installation

PC: Apple Macintosh series PC with at least one available USB port

NOTE

- Even when the requirements for the operating environment are satisfied, updated versions, multiboot environments, self-modified PCs and other compatible machines will not be covered under the operational warranty.

PC connection precautions

- When uploading or downloading a file to or from the voice recorder, data transfer will continue as long as the voice recorder's LED indicator light is flashing, even if the PC data communication screen disappears. Never disconnect the USB connector before data communication has finished. Always use the procedure on [P.107](#) to disconnect the USB connector. Data may not be transferred correctly if you disconnect the connector before the drive has stopped.
- Do not format (initialize) the voice recorder's drive from a PC. Formatting done from a PC will not be done correctly. Use the voice recorder's **[Format]** menu for formatting ([P.93](#)).
- Voice recorder folders or files that are moved or renamed in a Windows or Macintosh file management screen may be reordered or become unrecognizable.
- Note that it will still be possible to read and write data on the voice recorder after setting the attribute of the voice recorder's drive to 'Read only' on a PC.
- To prevent nearby electronic devices being affected by noise, disconnect the external microphone and earphones when connecting the voice recorder to a PC.

PC connection/disconnection

Connecting the voice recorder to a PC

- 1 Start the PC.
- 2 Slide the USB connector slide lever in the direction of the arrow.

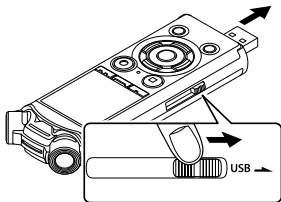

- 3 After making sure the voice recorder is in stop mode, connect its USB connector to a USB port on the PC.

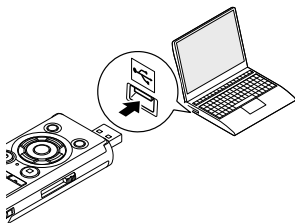

When you use an Olympus nickel-metal hydride rechargeable battery:

- To charge the battery, press the ►OK button.
- To cancel the battery charging, press any button other than ►OK.
- [Remote (Storage)] appears in the voice recorder's display when the USB connector is connected.
- The voice recorder will not connect to the PC if [AC Adapter] was selected for the voice recorder's [USB Connection] setting. Select [PC] for the [USB Connection] setting (☞ P.91).

TIP

- Windows: The voice recorder is recognized and displayed in the [Computer] folder with the model name as the drive name. If there is a microSD card in the voice recorder, it can be used as the [Removable Disk].
- Macintosh: The voice recorder is recognized and displayed on the desktop with the model name as the drive name. If there is a microSD card in the voice recorder, [NO NAME] is displayed.
- For information on the PC's USB port, see the PC's user manual.

NOTE

- Insert the USB connector securely all the way. Operation will not be normal if the connection is not made properly.
- Connecting the voice recorder through a USB hub may result in unstable operation. Do not use a USB hub if operation is unstable.
- Use only a compatible Olympus USB extension cable. Operation is not guaranteed if another manufacturer's cable is used. Only use the Olympus USB extension cable with the voice recorder and never use it with another manufacturer's products.

Disconnecting the voice recorder from a PC

Windows

- 1 Click **[Eject]** on the task bar in the lower right hand corner of the screen and click **[Eject DIGITAL VOICE RECORDER]**.



- The letter used to identify the drive will vary according to your PC.
- When the window indicating it is safe to remove hardware appears, close the window.

- 2 Check that the LED indicator light of the voice recorder has stopped blinking and then disconnect the USB cable.

TIP

- You can disconnect the USB cable and use the voice recorder before the battery is fully charged.

NOTE

- To prevent the risk of data damage, never disconnect the voice recorder from the USB port while the LED indicator light is flashing.

Macintosh

- 1 Drag-and-drop the removable disk icon for the voice recorder shown on the desktop to the trash can icon.



- 2 Check that the LED indicator light of the voice recorder has stopped blinking and then disconnect the USB cable.

Transferring files to a PC

When connecting the voice recorder to a PC you can transfer voice recorder data to save in the PC, and vice-versa. The voice recorder's five folders are displayed on the PC as **[FOLDER_A]**, **[FOLDER_B]**, **[FOLDER_C]**, **[FOLDER_D]** and **[FOLDER_E]** (Fig. C). You can copy voice recorder files to any folder on the PC (Fig. D).

Copying files recorded with the built-in microphone to a PC

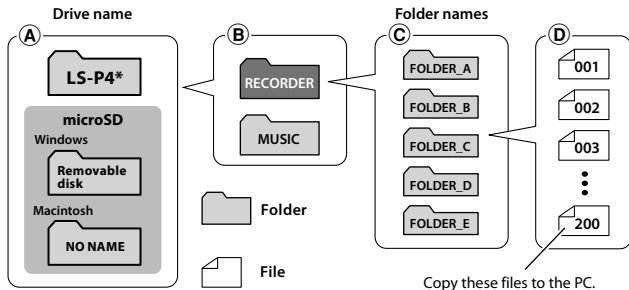

* Recognized/displayed by voice recorder drive name.

Transferring music files and study content

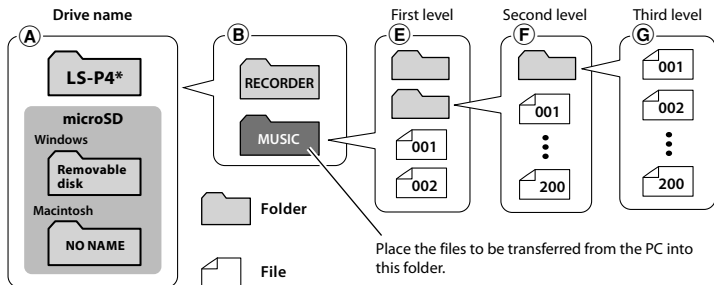

* Recognized/displayed by voice recorder drive name.

Transferring files to a PC

TIP

- Each folder can store up to 200 files.
- Up to 400 folders can be created within the **[Music]** folder (including a **[Music]** folder itself).
- The voice recorder can only recognize two folder sublevels.

Windows

- 1 Connect the voice recorder to the PC (P.105).**
- 2 Open Windows Explorer.**
 - When you open **[Computer]**, the voice recorder is recognized and displayed with the model name as the drive name.
- 3 Click on the folder labeled with your voice recorder's model name.**
- 4 Copy the desired data to the PC.**
- 5 Disconnect the voice recorder from the PC (P.107).**

Macintosh

- 1 Connect the voice recorder to the PC (P.105).**
 - When the voice recorder is connected to the Macintosh operating system, it is recognized and displayed on the desktop with the model name as the drive name.
- 2 Double-click the removable disk icon labeled with your voice recorder's model name.**
- 3 Copy the desired data to the PC.**
- 4 Disconnect the voice recorder from the PC (P.107).**

NOTE

- To prevent the risk of data damage, never disconnect the voice recorder from the USB port while the LED indicator light is flashing.

Other information

Alarm message list

Message	Meaning	Action required
Battery low	The remaining battery power is low.	Replace or charge the battery (☞ P.9, P.12).
File locked	An attempt was made to erase a locked file.	You must unlock the file before you can erase it (☞ P.57).
Further marking not possible	The maximum number of index marks (99 (16*)) have been written in the file.	Erase unneeded index marks (☞ P.48).
	The maximum number of temp marks (99 (16*)) have been written in the file.	Erase unneeded temp marks (☞ P.48).
Folder full	The maximum number of files (200) have been saved in the folder.	Erase unneeded files (☞ P.52).
Memory error	An internal memory error occurred.	Contact the Olympus Customer Support Center (☞ back cover).
Card error	The microSD card was not recognized correctly.	Remove and reinsert the microSD card (☞ P.18, P.19).
Memory full	There is no remaining memory.	Erase unneeded files (☞ P.52).
No file	There are no files in the folder.	Select another folder (☞ P.23).
Format error	A formatting problem occurred.	Format the memory again (☞ P.93).
Can't create the system file. Connect to PC and erase unnecessary file	The voice recorder is unable to create a management file due to low remaining memory.	Connect the voice recorder to a PC and erase unneeded files.
Cannot play this file	The file's format is not supported.	Select a file that can be played by the voice recorder (☞ P.43).
Select a file	No file has been selected.	You must select a file before you can perform the operation (☞ P.23).

Alarm message list

Message	Meaning	Action required
Same folder Can't move (copy)	An attempt was made to move (copy) a file to the same folder.	Select another folder.
Some files can't be moved (copied)	A file with the same name as a file being moved (copied) exists in the destination folder.	Select another file.
This file can't be divided.	An attempt was made to divide a file that is not an MP3- or WAV-format file recorded by the voice recorder.	Select another file.
Partial erase not possible	An attempt was made to erase a file that is not a WAV-format file recorded by the voice recorder.	Select another file.

* LS-P1 model only

Troubleshooting

Problem	Possible cause	Solution
The display is blank.	The battery is not inserted properly.	Check that the positive and negative terminals of the battery are placed correctly (☞ P.9).
	The remaining battery power is low.	Replace or charge the battery (☞ P.9, P.12).
	The power is OFF.	Turn the power ON (☞ P.10).
Unable to operate the voice recorder	The remaining battery power is low.	Replace or charge the battery (☞ P.9, P.12).
	The power is OFF.	Turn the power ON (☞ P.10).
	The voice recorder is in HOLD mode.	Release HOLD mode (☞ P.20).
Unable to record	There is no remaining memory.	Erase unneeded files (☞ P.52).
	The maximum number of recordable files has been reached.	Select another folder (☞ P.23).
Playback is inaudible.	The earphones are connected to the earphone jack.	To output the playback through the built-in speaker, disconnect the earphones.
	[Off] has been selected for [Speaker].	To output the playback through the built-in speaker, select [On] for [Speaker] (☞ P.72).
	The volume is set to [00].	Adjust the volume (☞ P.39).
The recording is too quiet.	A low recording level has been set.	Redo recording after setting the recording level to [High] or [Middle] (☞ P.60).
	The output level of the connected external device may be too low.	Adjust the output level of the external device.
	The recording level hasn't been adjusted.	Redo recording after adjusting the recording level (☞ P.60).

Problem	Possible cause	Solution
Audio file sound is distorted.	The recording level hasn't been adjusted.	Redo recording after adjusting the recording level (☞ P.60).
	The voice recorder's recording level, or the output level of the connected external device may be too high.	If the problem continues after adjusting the voice recorder's recording level (☞ P.60), adjust the output level of the external device.
An audio file is not recorded in stereo.	The connected external microphone is a mono microphone.	Sound recorded by a connected external mono microphone is recorded on the left channel only.
	[Rec Mode] is set to a mono recording format.	Set [Rec Mode] to a stereo recording format (☞ P.61).
	A positive (+) value has been selected for [Zoom Mic].	Select [Off] for [Zoom Mic] (☞ P.62).
Missing audio file	The file was recorded in a different folder.	Select another folder (☞ P.23).
Noise during playback	Objects brushed against the voice recorder while recording.	Try your best not to touch the voice recorder during recording.
	The voice recorder was placed near a mobile phone or fluorescent light during recording or playback.	Redo the operation with the voice recorder in a different location.
Non-voice portions are not skipped during playback.	The [Voice Detect] process has not been performed.	Use the [Voice Detect] function to extract the speaking portions (☞ P.77).
	[Off] has been selected for [Voice Playback].	Select [On] for [Voice Playback] (☞ P.67).
Unable to erase a file	The file is locked.	You must unlock the file before you can erase it (☞ P.57).
	The file is a read-only file.	Unlock the file, or undo the read-only setting on a PC.

Troubleshooting

Problem	Possible cause	Solution
Unable to erase a folder	The folder contains a file that the voice recorder cannot recognize.	Connect the voice recorder to a PC to erase the folder (☞ P.105).
Noise when monitoring a recording	Feedback is being caused.	Connecting a speaker with a built-in amplifier may cause feedback during recording. Using the earphones to monitor recording is recommended. Adjust the recording setup such as by moving the earphones and microphone farther apart, or ensuring the microphone is not facing the earphones.
Unable to overdub	LS-P4 model only	
	The file to be played back is not in [PCM 44.1kHz/16bit] or [PCM 44.1kHz mono] format.	Select a file recorded in [PCM 44.1kHz/16bit] or [PCM 44.1kHz mono] format (☞ P.23, P.39).
	[PCM 44.1kHz/16bit] or [PCM 44.1kHz mono] is not set for [Rec Mode].	Set [PCM 44.1kHz/16bit] or [PCM 44.1kHz mono] for [Rec Mode]. (☞ P.61).
Unable to write index marks/temp marks	The maximum number of marks (99 (16*)) has been reached.	Erase unneeded marks (☞ P.49).
	The file is locked.	Unlock the file (☞ P.57).
	The file is a read-only file.	Unlock the file, or undo the read-only setting on a PC.
Unable to charge the battery.	[Alkaline] has been selected for [Battery].	To use the rechargeable battery provided, select [Ni-MH] for [Battery]. Do not use the rechargeable battery at higher/lower temperatures than the recommended range (☞ P.10, P.16, P.73).
	The ►OK button was not pressed.	Press the ►OK button as directed in the confirmation screen shown when connecting the USB connector.
	[Composite] has been selected for [USB Class].	Select [Storage Class] for [USB Class] (☞ P.91).
The PC is unable to recognize the voice recorder.	[AC Adapter] has been selected for [USB Connection].	Select [PC] for [USB Connection] (☞ P.91).
Playback speed is fast (or slow).	Playback speed function is set to anything other than [x1.0 Play].	Set the playback speed function setting to [x1.0 Play] (☞ P.44).

Troubleshooting

Problem	Possible cause	Solution
Operation is different from usual.	The settings of functions have been changed.	Try [Reset settings]. Various functions will be restored to their initial (factory default) settings. Time clock settings and recorded files are retained (☞ P.75).
Unable to connect with a Bluetooth® device.	LS-P4 model only	
	The Bluetooth® device to be connected is not in a connectable state.	Make the Bluetooth® device connectable and then try configuring the settings again (☞ P.98).
	The distance between the Bluetooth® device and voice recorder is too far or there is an obstruction between them.	Place the Bluetooth® device within 1 m of the voice recorder and then try configuring the settings again (☞ P.98).
	The pairing information has been deleted.	Perform pairing setting again (☞ P.98).
Noise is output when a Bluetooth® device is used.	LS-P4 model only	
	The distance between the Bluetooth® device and voice recorder is too far or there is an obstruction between them.	Use the device close to the voice recorder.
The volume cannot be changed with the recorder while playing a file on a Bluetooth® device.	LS-P4 model only	
	The volume for a file being played on a Bluetooth® device cannot be changed using the recorder.	Change the volume with the Bluetooth® device.
Recording cannot be monitored from a Bluetooth® device.	LS-P4 model only	
	Recording on a Bluetooth® device cannot be monitored from the Bluetooth® device.	You can monitor the recording from the recorder (☞ P.31).

* LS-P1 model only

Recorder care

● Exterior

- Wipe gently with a soft cloth when the recorder gets dirty. If the recorder is very dirty, soak the cloth in mild soapy water and wring well. Wipe the recorder with the damp cloth and then wipe it with a dry cloth.

● Display

- Wipe gently with a soft cloth.

NOTE

- Do not use benzene, alcohol or other strong solvents, or chemical cleaning cloths.

Accessories (optional)

Accessories for Olympus voice recorders can be purchased directly from the Online Shop on the Olympus website.

Availability of accessories differs depending on the country.

ME51SW stereo microphone

Has a large-diameter built-in microphone for sensitive stereo recording.

ME30W two-channel microphone (omnidirectional)

An omnidirectional microphone pair with a low-noise design ideal for recording in lecture halls or other large venues. The left and right microphones can be placed up to about 5 meters apart.

ME31 compact gun microphone (unidirectional)

A directional gun microphone handy for outdoor recording of wild birds singing and other highly directional applications. The metal body provides a highly rigid body.

ME34 compact zoom microphone (unidirectional)

Comes with an integrated stand ideal for table placement when recording events from a distance, such as conferences or lectures.

ME33 boundary microphone

A microphone for recording conferences that enables connection of up to three left- and three right-channel units. Cascade connection enables the left/right channel connections to be extended up to about 12 meters, to capture sound from a broad range.

TP8 telephone pickup microphone

An earphone microphone that can be worn in the ear during phone calls. Clearly captures voices and conversations during phone calls.

BR404 nickel-metal hydride AAA rechargeable battery

A high-efficiency, long-lasting rechargeable battery.

A514 USB-connection AC adapter

A USB-connected AC adapter that provides 5-volt DC output. (100-240 VAC, 50/60 Hz)

KA333 connecting cord

A resistive connection cord with stereo mini-plugs (3.5 mm diameter) on both ends. Used to connect the earphone jack output to the line input when recording. Comes with plug adapters (PA331/PA231) that adapt to mono mini plugs (3.5 mm diameter) or mono mini mini plugs (2.5 mm diameter).

CL4 Stand clip

A clip for securing the voice recorder. It can also be used as a stand when placing the voice recorder on a table.

CS150 Carrying case

WJ2 Windshield

Reduces low-frequency wind noise.

Copyright and trademark information

- The information in this document is subject to change in future without prior notice. Contact Olympus Customer Support Center for the latest product names, model numbers and other information.
- Voice recorder displays and product illustrations shown in this manual may differ from the actual product. While every precaution has been taken to ensure the accuracy of the information in this manual, errors may occasionally arise. Any questions or concerns regarding doubtful information, or possible errors or omissions should be directed to the Olympus Customer Support Center.
- Olympus Corporation is the copyright holders of this manual. Copyright law prohibits unauthorized reproduction of this manual, or unauthorized distribution of reproductions thereof.
- Note that Olympus will assume no liability in the event of damages, lost earnings, or any claims from third parties resulting from improper use of the product.

Trademarks and registered trademarks

- IBM and PC/AT are trademarks or registered trademarks of International Business Machines Corporation.
- Microsoft and Windows are registered trademarks of Microsoft Corporation.
- microSD and microSDHC are trademarks of the SD Card Association.
- Macintosh is a trademark of Apple Inc.
- The product uses voice activity detection technology licensed from NTT Electronics Corporation.
- Android and Google Play are trademarks or registered trademarks of Google Inc.
- The Bluetooth® word mark and logos are registered trademarks owned by Bluetooth SIG, Inc. and any use of such marks by OLYMPUS Corporation is under license. Other trademarks and trade names are those of their respective owners.

All other brand or product names in this manual are the trademarks or registered trademarks of their respective owners.



Notes



WARNING

- **Turn off the voice recorder in a hospital or near medical electric devices.**
Electric waves from the voice recorder could affect electric medical devices and could cause accidents due to malfunction.
- **Keep a distance of at least 22cm from persons who have a pacemaker.**
Electric waves from this voice recorder could affect the operation of a pacemaker.
- **Turn OFF the voice recorder when onboard aircraft.**
Using wireless devices onboard may hinder safe operation of the aircraft.

This product includes software created by the third party. The third party software is distributed to you based on the prescribed conditions imposed by its owner or copyright holder. These conditions are shown below.

libFLAC - Free Lossless Audio Codec library
Copyright © 2000-2009 Josh Coalson
Copyright © 2011-2013 Xiph.Org Foundation

Redistribution and use in source and binary forms, with or without modification, are permitted provided that the following conditions are met:

- Redistributions of source code must retain the above copyright notice, this list of conditions and the following disclaimer.
- Redistributions in binary form must reproduce the above copyright notice, this list of conditions and the following disclaimer in the documentation and/or other materials provided with the distribution.
- Neither the name of the Xiph.org Foundation nor the names of its contributors may be used to endorse or promote products derived from this software without specific prior written permission.

THIS SOFTWARE IS PROVIDED BY THE COPYRIGHT HOLDERS AND CONTRIBUTORS "AS IS" AND ANY EXPRESS OR IMPLIED WARRANTIES, INCLUDING, BUT NOT LIMITED TO, THE IMPLIED WARRANTIES OF MERCHANTABILITY AND FITNESS FOR A PARTICULAR PURPOSE ARE DISCLAIMED. IN NO EVENT SHALL THE FOUNDATION OR CONTRIBUTORS BE LIABLE FOR ANY DIRECT, INDIRECT, INCIDENTAL, SPECIAL, EXEMPLARY, OR CONSEQUENTIAL DAMAGES (INCLUDING, BUT NOT LIMITED TO, PROCUREMENT OF SUBSTITUTE GOODS OR SERVICES; LOSS OF USE, DATA, OR PROFITS; OR BUSINESS INTERRUPTION) HOWEVER CAUSED AND ON ANY THEORY OF LIABILITY, WHETHER IN CONTRACT, STRICT LIABILITY, OR TORT (INCLUDING NEGLIGENCE OR OTHERWISE) ARISING IN ANY WAY OUT OF THE USE OF THIS SOFTWARE, EVEN IF ADVISED OF THE POSSIBILITY OF SUCH DAMAGE.

Safety precautions

Before using the voice recorder, read this manual to ensure correct and safe operation. After reading this manual, be sure to keep it on hand for ready reference whenever needed.

Important safety precautions

- Important safety precautions in this manual are accompanied by the symbol and labels below. Always follow these precautions to prevent harming yourself or others, or causing damage to property.
- The meaning of each precaution type is given below.

DANGER

A precaution about an imminent danger that is expected to result in death or serious injury if equipment is handled incorrectly.

WARNING

A precaution about a situation that is expected to potentially result in death or serious injury if equipment is handled incorrectly.

CAUTION

A precaution about a situation that is expected to potentially result in injury, or is expected to result only in property damage, if equipment is handled incorrectly.

Voice recorder safety precautions

WARNING

- **Do not use the voice recorder in an atmosphere that might contain flammable or explosive gases.**
It may cause fire or explosion.
- **Do not attempt to disassemble, repair or modify the voice recorder.**
It may cause electric shock or injury.
- **Do not operate the voice recorder while operating a vehicle (such as a bicycle, motorcycle or car).**
It may cause traffic accidents.
- **Do not leave the voice recorder in a location accessible to infants and children.**

Pay attention when using the voice recorder near an infant or child, taking care not to leave it unattended. Infants and children are unable to understand voice recorder safety precautions, and are at risk of accidents such as:

- Strangulation caused by accidental entanglement of the earphone cord around the neck.
- Operation errors resulting in injury or electric shock.

- **If you notice unusual odor, noise, heat, burning odor or smoke coming from the recorder:**

- ① Disconnect the battery and USB connection immediately, taking care not to burn or injure yourself. Continued use may result in fire or burns (Do not touch the product with bare hands when it's overheating).
- ② Contact your place of purchase or an Olympus service center.

Safety precautions

- **Do not use the USB power supply via the car cigarette lighter socket or the self-modified power supply.**

It may cause overheating, fire, electric shock or malfunctions.

- **Use microSD/microSDHC memory cards only. Never place other types of cards in the voice recorder.**

If another card type is placed in the voice recorder by accident, do not try to pull it out by force. Contact an Olympus repair center or service center.

- **If the voice recorder is dropped in water or, if water, metal or combustible foreign matter gets inside:**

- ① Remove the battery immediately.
- ② Contact your place of purchase or an Olympus service center for repair. Continued use may result in fire or electric shock.

- **Do not use the voice recorder or use it only as directed in airplanes, hospitals or other locations where use of electronic devices is restricted.**

- **Stop using the voice recorder if you notice unusual odor, noise, or smoke coming from it.**

It may cause fire or burns. Remove the battery immediately, taking care not to burn yourself. Contact your place of purchase or an Olympus repair center or service center. (Do not touch the battery with bare hands when removing it. Remove the battery outdoors, and away from flammable objects.)

- **When carrying the voice recorder by its strap, take care to prevent it becoming caught on other items.**



CAUTION

- **Do not raise the volume before performing an operation.**
Hearing damage or loss may result.

Batteries



DANGER

- **Do not place the battery near ignition sources.**
- **Do not incinerate, heat or disassemble the battery. Do not short-circuit the battery's positive and negative electrodes.**
It may cause fire, ruptures, combustion or overheating.
- **Do not solder connections directly onto the battery. Do not deform, modify or disassemble the battery.**
- **Do not connect the battery's positive and negative terminals.**
It may cause overheating, electric shock or fire.
- **When carrying or storing the battery, always place it in the case and protect its terminals. Do not carry or store the battery together with precious metal items such as key rings.**
It may cause overheating, electric shock or fire.

Safety precautions

- **Do not connect the battery directly to a power outlet or car cigarette lighter.**
- **Do not use or leave the battery in a hot location such as in direct sunlight, inside a vehicle on a hot day, or near a room heater.**

It may cause fire, burns or injuries from leaking, overheating or ruptures.



WARNING

- **Do not touch or hold the battery with wet hands.**

It may cause electric shock or malfunctions.

- **Do not use a battery with a scratched or damaged case.**
- **Do not insert the battery with its positive/negative terminals in the opposite direction.**

It may cause leaking, overheating, combustion or ruptures.

- Do not use a battery with a torn casing seal (insulating covering).
- Always remove the battery when the voice recorder will not be used for an long period.
- When disposing used batteries, insulate their contacts with tape and discard them as general waste in the manner prescribed by the local authority.
- Remove the battery from the voice recorder as soon as the battery becomes unusable. It may cause leakage.

- **Battery fluid in the eyes may cause blindness. If battery fluid gets in eyes, do not rub the eyes. Instead, rinse them thoroughly with tap water or other clean water right away. Go to doctor immediately.**
- **Do not attempt to recharge alkaline, lithium or any other non-rechargeable batteries.**
- **Keep the battery out of the reach of infants and children.**

The battery could be swallowed by infants and children. If swallowed, go to doctor immediately.

- **Do not submerge the battery in freshwater or saltwater, or allow its terminals to become wet.**
- **Discontinue use of the battery if it develops a problem such as leaking, discoloration or deformation.**
- **Stop charging the rechargeable battery if charging has not finished after the specified amount of charging time.**
- **Battery fluid on clothing or skin may damage the skin, so rinse the battery fluid off right away with tap water or other clean water.**



CAUTION

- **Do not throw the battery around, or subject it to strong shocks.**
- **Always charge the rechargeable battery before use when using it for the first time or if it has not been used for a long time.**

Safety precautions

- **Rechargeable batteries have a limited life. When the recorders operating time becomes shorter after recharging under the specified condition, please consider that battery is expired and replace it with a new one.**

- **There is a risk of explosion if the battery is replaced with the incorrect battery type. When disposing used batteries follow the instructions.**

Please recycle batteries to help save our planet's resources. When you throw away dead batteries, be sure to cover their terminals and always observe local laws and regulations.

Disposing the rechargeable battery

- **Recycling batteries helps saving resources. When disposing a used battery, always cover its terminals and observe local laws and regulations.**

Operating precautions

- Do not leave the voice recorder in hot or humid locations such as in direct sunlight inside a vehicle, or on a beach during summer.
- Do not store the voice recorder in humid or dusty locations.
- If the voice recorder becomes wet or damp, wipe off the moisture right away with a dry cloth. Contact with salt water should be particularly avoided.
- Do not place the voice recorder on top of or near a TV, refrigerator or other electrical appliance.
- Prevent sand or mud from getting on the voice recorder. It may cause product not to be repairable.
- Do not subject the voice recorder to intense vibrations or shocks.
- Do not use the voice recorder in humid locations.
- Placing a magnetic card (such as a bank cash card) near the speaker or earphones may cause errors in the data stored on the magnetic card.
- Noise may be heard when the voice recorder is placed near an electric lamp line, fluorescent light or a mobile phone during recording or playback.

Safety precautions

<Data loss precautions>

- Recorded content in the internal memory and microSD card may be destroyed or lost due to reasons such as operating errors, device failure or repair.
- Also, when content is saved in the memory for long period of time or is used repeatedly, operations such as writing to, reading from, or erasing of contents may not be possible.
- Making a backup of important recorded information and saving it on a PC's hard disk or other recording media is recommended.
- Note that Olympus will assume no liability for damages or lost earnings resulting from recorded data damage or loss, regardless of the nature or cause thereof.

<Recorded file precautions>

- Note that Olympus will assume no liability for recorded files being erased or becoming unplayable due to voice recorder or PC failure.
- Recording of copyrighted material is permitted when the recording is for your personal use only. Any other type of use without the permission of the copyright owner is prohibited by copyright law.

<Voice recorder and microSD cards disposal precautions>

- Even when formatting (P.93) or erasing (P.52) are performed, only the file management information of the internal memory and/or microSD card is updated and the recorded data is not completely erased.

When disposing of the voice recorder or a microSD card, be sure to destroy it, format and record silence until the recording time runs out, or perform a similar operation in order to prevent the leakage of personal information.

Specifications

General items

■ Recording formats

Linear PCM format

FLAC* format

MP3 format

* LS-P4 model only

■ Input level

- 60 dBv

■ Sampling frequency

Linear PCM/FLAC* format

96.0 kHz/24 bits	96.0 kHz
88.2 kHz/24 bits	88.2 kHz
48.0 kHz/24 bits*	48.0 kHz
48.0 kHz/16 bits	48.0 kHz
44.1 kHz/24 bits*	44.1 kHz
44.1 kHz/16 bits	44.1 kHz
44.1 kHz mono	44.1 kHz

MP3 format

320 kbps	44.1 kHz
128 kbps	44.1 kHz
64 kbps mono	44.1 kHz

* LS-P4 model only

■ Maximum working output

150 mW (8 Ω speaker)

■ Maximum output voltage

Recorder: ≤ 150 mV

(according to EN 50332-2)

■ Recording media*

Internal NAND flash memory:

LS-P4: 8 GB

LS-P1: 4 GB

microSD card

(Supports card capacities ranging from 2 to 32 GB.)

* Some recording media memory capacity is used as a management area, so the actual usable capacity will always be slightly less than the displayed capacity.

■ Bluetooth® Specification*1

Standard: Version 2.1+ EDR Support

Transmit Power Level: Class2

Communication Distance:

Line of sight approx. 10 m*2 (max.)

Operational Frequency Range:

2.4 GHz to 2.4835 GHz

2 mW or less

Modulation Method: FHSS

Firmware: Ver. 1.0 or later

Compatible Profiles:

A2DP (Advanced Audio Distribution Profile)

AVRCP (Audio/Video Remote Control Profile)

HSP (Headset Profile)

HFP (Handsfree Profile)

SPP (Serial Port Profile)

*1 LS-P4 model only

*2 The communication distance is guideline values. The communication distance may vary depending on ambient conditions.

■ Speaker

Built-in 18 mm diameter round dynamic speaker

■ Microphone jack

3.5 mm diameter; Impedance: 2 kΩ

Specifications

■ Earphones jack

3.5 mm diameter; Impedance: 8 Ω minimum

■ Power source

Standard voltage: 1.5 V

Battery: One AAA dry cell battery (model LR03), or one Olympus nickel-metal hydride rechargeable battery (always use an Olympus BR404 for charging with the recorder)

External power supply: USB-connection AC adapter (model A514; 5 VDC)

■ External dimensions

108.9 × 39.6 × 14.4 mm
(Not including largest projection)

■ Weight

75 g (including battery)

■ Operating temperature

0 to 42°C (32 to 107.6°F)

Frequency response

■ When recording from microphone jack

Linear PCM/FLAC* format

96.0 kHz/24 bits	20 Hz to 44 kHz
88.2 kHz/24 bits	20 Hz to 42 kHz
48.0 kHz/24 bits*	20 Hz to 23 kHz
48.0 kHz/16 bits	20 Hz to 23 kHz
44.1 kHz/24 bits*	20 Hz to 21 kHz
44.1 kHz/16 bits	20 Hz to 21 kHz
44.1 kHz mono	20 Hz to 21 kHz

MP3 format

320 kbps	20 Hz to 21 kHz
128 kbps	20 Hz to 17 kHz
64 kbps mono	20 Hz to 13 kHz

* LS-P4 model only

■ When recording with built-in stereo microphone

LS-P4:

20 Hz to 20 kHz ((**Central Mic On**))

60 Hz to 20 kHz ((**Central Mic Off**))

LS-P1:

60 Hz to 20 kHz

(Frequency response upper limit is set by recording mode during MP3-format recording.)

■ During playback

20 Hz to 44 kHz

(The upper and lower limit values of the frequency response depend on each recording format.)

Battery life

The figures below are guideline values.

■ When recording with built-in stereo microphone (using internal memory)

Recording mode		Alkaline dry cell battery	Nickel-metal hydride rechargeable battery
Linear PCM format	96.0 kHz/24 bits	16 hours (approx.)	13 hours (approx.)
	88.2 kHz/24 bits	17 hours (approx.)	14 hours (approx.)
	48.0 kHz/24 bits*	24 hours (approx.)	17 hours (approx.)
	48.0 kHz/16 bits	26 hours (approx.)	20 hours (approx.)
	44.1 kHz/24 bits*	25 hours (approx.)	17 hours (approx.)
	44.1 kHz/16 bits	28 hours (approx.)	21 hours (approx.)
	44.1 kHz mono	32 hours (approx.)	24 hours (approx.)
FLAC* format	96.0 kHz/24 bits	11 hours (approx.)	9 hours (approx.)
	88.2 kHz/24 bits	12 hours (approx.)	11 hours (approx.)
	48.0 kHz/24 bits	13 hours (approx.)	12 hours (approx.)
	48.0 kHz/16 bits	15 hours (approx.)	14 hours (approx.)
	44.1 kHz/24 bits	18 hours (approx.)	15 hours (approx.)
	44.1 kHz/16 bits	19 hours (approx.)	16 hours (approx.)
	44.1 kHz mono	21 hours (approx.)	18 hours (approx.)
MP3 format	320 kbps	31 hours (approx.)	22 hours (approx.)
	128 kbps	35 hours (approx.)	25 hours (approx.)
	64 kbps mono	39 hours (approx.)	28 hours (approx.)

* LS-P4 model only

Specifications

■ During audio file playback (all playback modes)

During speaker playback

Recording mode		Alkaline dry cell battery	Nickel-metal hydride rechargeable battery
Linear PCM format	96.0 kHz/24 bits	11 hours (approx.)	10 hours (approx.)
	88.2 kHz/24 bits	11 hours (approx.)	10 hours (approx.)
	48.0 kHz/24 bits*	12 hours (approx.)	11 hours (approx.)
	48.0 kHz/16 bits	13 hours (approx.)	11 hours (approx.)
	44.1 kHz/24 bits*	13 hours (approx.)	11 hours (approx.)
	44.1 kHz/16 bits	13 hours (approx.)	11 hours (approx.)
	44.1 kHz mono	13 hours (approx.)	11 hours (approx.)
FLAC* format	96.0 kHz/24 bits	8 hours (approx.)	7 hours (approx.)
	88.2 kHz/24 bits	9 hours (approx.)	8 hours (approx.)
	48.0 kHz/24 bits	12 hours (approx.)	10 hours (approx.)
	48.0 kHz/16 bits	12 hours (approx.)	11 hours (approx.)
	44.1 kHz/24 bits	12 hours (approx.)	11 hours (approx.)
	44.1 kHz/16 bits	12 hours (approx.)	11 hours (approx.)
	44.1 kHz mono	12 hours (approx.)	11 hours (approx.)
MP3 format	320 kbps	13 hours (approx.)	11 hours (approx.)
	128 kbps	13 hours (approx.)	11 hours (approx.)
	64 kbps mono	13 hours (approx.)	11 hours (approx.)

* LS-P4 model only

Specifications

During earphone playback

Recording mode		Alkaline dry cell battery	Nickel-metal hydride rechargeable battery
Linear PCM format	96.0 kHz/24 bits	17 hours (approx.)	14 hours (approx.)
	88.2 kHz/24 bits	18 hours (approx.)	15 hours (approx.)
	48.0 kHz/24 bits*	26 hours (approx.)	20 hours (approx.)
	48.0 kHz/16 bits	26 hours (approx.)	20 hours (approx.)
	44.1 kHz/24 bits*	28 hours (approx.)	21 hours (approx.)
	44.1 kHz/16 bits	28 hours (approx.)	21 hours (approx.)
	44.1 kHz mono	31 hours (approx.)	22 hours (approx.)
FLAC* format	96.0 kHz/24 bits	16 hours (approx.)	12 hours (approx.)
	88.2 kHz/24 bits	16 hours (approx.)	12 hours (approx.)
	48.0 kHz/24 bits	25 hours (approx.)	19 hours (approx.)
	48.0 kHz/16 bits	28 hours (approx.)	20 hours (approx.)
	44.1 kHz/24 bits	30 hours (approx.)	21 hours (approx.)
	44.1 kHz/16 bits	31 hours (approx.)	22 hours (approx.)
	44.1 kHz mono	31 hours (approx.)	22 hours (approx.)
MP3 format	320 kbps	30 hours (approx.)	22 hours (approx.)
	128 kbps	30 hours (approx.)	22 hours (approx.)
	64 kbps mono	31 hours (approx.)	22 hours (approx.)

* LS-P4 model only

NOTE

- The battery life figures shown here were determined using an Olympus test method (When **[Mic Select]*** is set to **[Central Mic Off]**, and **[LED]** is set to **[Off]**). Actual battery life figures will vary greatly according to the battery used and usage conditions (Changing the playback speed or using the **[Zoom Mic]**, **[Noise Cancel]**, **[Voice Balancer]** and **[Bluetooth]** functions may affect the battery life).
- Battery life will be shorter when using a nickel-metal hydride rechargeable battery that has been used repeatedly.
- Battery life will be shorter when using a microSD card.

* LS-P4 model only

Specifications

Recording time

The figures below are guideline values.

■ Linear PCM format

Recording mode	Internal memory		microSD card		
	LS-P4 (8GB)	LS-P1 (4GB)	32 GB	16 GB	8 GB
96.0 kHz/24 bits	3 hours, 30 minutes (approx.)	1 hour, 30 minutes (approx.)	14 hours, 30 minutes (approx.)	7 hours, 15 minutes (approx.)	3 hours, 30 minutes (approx.)
88.2 kHz/24 bits	3 hours, 45 minutes (approx.)	1 hour, 45 minutes (approx.)	16 hours (approx.)	7 hours, 45 minutes (approx.)	3 hours, 45 minutes (approx.)
48.0 kHz/24 bits*	7 hours (approx.)	—	29 hours (approx.)	14 hours, 30 minutes (approx.)	7 hours, 15 minutes (approx.)
48.0 kHz/16 bits	10 hours, 30 minutes (approx.)	5 hours (approx.)	44 hours (approx.)	22 hours (approx.)	11 hours (approx.)
44.1 kHz/24 bits*	7 hours, 30 minutes (approx.)	—	32 hours (approx.)	15 hours, 30 minutes (approx.)	7 hours, 45 minutes (approx.)
44.1 kHz/16 bits	11 hours (approx.)	5 hours, 30 minutes (approx.)	48 hours (approx.)	23 hours, 30 minutes (approx.)	11 hours, 30 minutes (approx.)
44.1 kHz mono	22 hours, 30 minutes (approx.)	11 hours (approx.)	96 hours (approx.)	47 hours, 30 minutes (approx.)	23 hours, 30 minutes (approx.)

* LS-P4 model only

Specifications

■ FLAC* format

Recording mode	Internal memory		microSD card		
	LS-P4 (8GB)	32 GB	16 GB	8 GB	
96.0 kHz/24 bits	5 hours (approx.)	21 hours (approx.)	10 hours (approx.)	5 hours (approx.)	
88.2 kHz/24 bits	5 hours, 15 minutes (approx.)	22 hours, 30 minutes (approx.)	11 hours (approx.)	5 hours, 30 minutes (approx.)	
48.0 kHz/24 bits	10 hours (approx.)	42 hours (approx.)	20 hours, 30 minutes (approx.)	10 hours (approx.)	
48.0 kHz/16 bits	15 hours (approx.)	63 hours (approx.)	31 hours (approx.)	15 hours, 30 minutes (approx.)	
44.1 kHz/24 bits	10 hours, 30 minutes (approx.)	45 hours, 30 minutes (approx.)	22 hours, 30 minutes (approx.)	11 hours (approx.)	
44.1 kHz/16 bits	16 hours (approx.)	68 hours (approx.)	34 hours (approx.)	17 hours (approx.)	
44.1 kHz mono	32 hours, 30 minutes (approx.)	137 hours (approx.)	68 hours (approx.)	34 hours (approx.)	

* LS-P4 model only

■ MP3 format

Recording mode	Internal memory		microSD card		
	LS-P4 (8GB)	LS-P1 (4GB)	32 GB	16 GB	8 GB
320 kbps	50 hours (approx.)	24 hours, 30 minutes (approx.)	212 hours (approx.)	105 hours (approx.)	52 hours (approx.)
128 kbps	126 hours (approx.)	61 hours (approx.)	530 hours (approx.)	264 hours (approx.)	132 hours (approx.)
64 kbps mono	253 hours (approx.)	123 hours (approx.)	1060 hours (approx.)	525 hours (approx.)	264 hours (approx.)

NOTE

- Actually available recording times may be shorter than the figures shown here when making short recordings repeatedly (Equipment displays of available/elapsed recording times should be considered guideline values).
- Available recording time will also vary due to differences in the available memory capacity of different microSD cards.

Specifications

Maximum recording time per file

- The maximum file size is limited to approximately 2 GB in linear PCM (WAV) format, and approximately 4 GB in FLAC*/MP3 format.
- Regardless of the amount of remaining memory, the maximum recording time per file is restricted to the following values:

* LS-P4 model only

Linear PCM format

Recording mode	Recording time
96.0 kHz/24 bits	1 hour (approx.)
88.2 kHz/24 bits	1 hour (approx.)
48.0 kHz/24 bits*	2 hours (approx.)
48.0 kHz/16 bits	3 hours (approx.)
44.1 kHz/24 bits*	2 hours (approx.)
44.1 kHz/16 bits	3 hours, 20 minutes (approx.)
44.1 kHz mono	6 hours, 40 minutes (approx.)

* LS-P4 model only

FLAC* format

Recording mode	Recording time
96.0 kHz/24 bits	2 hours, 50 minutes (approx.)
88.2 kHz/24 bits	3 hours, 10 minutes (approx.)
48.0 kHz/24 bits	5 hours, 50 minutes (approx.)
48.0 kHz/16 bits	8 hours, 50 minutes (approx.)
44.1 kHz/24 bits	6 hours, 20 minutes (approx.)
44.1 kHz/16 bits	9 hours, 30 minutes (approx.)
44.1 kHz mono	19 hours, 10 minutes (approx.)

* LS-P4 model only

MP3 format

Recording mode	Recording time
320 kbps	29 hours, 40 minutes (approx.)
128 kbps	74 hours, 30 minutes (approx.)
64 kbps mono	149 hours (approx.)

Number of music tracks (songs) that can be recorded

The figures below are guideline values.

LS-P4 (8 GB)	1850 tracks (approx.)
LS-P1 (4 GB)	900 tracks (approx.)

(At 128 kbps, 4 minutes per track)

Note that voice recorder specifications and appearance are subject to change without prior notice for performance improvements or other upgrading.

Additions/modifications by firmware update

The following functions are added/modified by firmware update.

■ Additions/modifications by the firmware version 1.10

New recording-related menu items *	☞ P.133
Recording a Reference Tone for Use When Synchronizing Audio and Video: [Slate Tone] *	☞ P.134
Adjusting Sound Level for Output to the Camera: [Test Tone] *	☞ P.137

* LS-P4 model only

Additions/modifications by the firmware version 1.10

Using the voice recorder as an external microphone when filming videos with your digital camera yields sound of better quality than audio recorded via the camera's built in mic.

New recording-related menu items

The following items have been added to the menu in the recording tab.

📌 LS-P4 model only

Tab	Menu items	Description/options
[Rec Menu]	[Slate Tone] ☞ P.134	Emit and record a slate (reference) tone during filming. [On] [Off]
	[Test Tone] ☞ P.137	Adjust audio output with reference to a test tone emitted at a selected volume. [00] - [30]

📌 Default options are highlighted in **gray**.

Additions/modifications by the firmware version 1.10

Recording a Reference Tone for Use When Synchronizing Audio and Video: [Slate Tone]

Reference tones, otherwise known as “slate tones”, can be recorded for use during editing to help synchronize audio and video when audio from the voice recorder is substituted for sound recorded by the camera (☞ P.136).

LS-P4 model only

Selecting [On] for [Slate Tone]

- 1 Press the **MENU/SCENE** button while the voice recorder is in stop mode.
- 2 Press the **+ or –** button to select the [Rec Menu] tab.
- 3 Press the **▶OK** button to move the cursor into the list of setting items.
- 4 Press the **+ or –** button to select [Slate Tone].

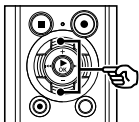

- 6 Press the **+ or –** button to select [On].

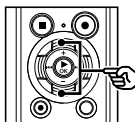

- 7 Press the **▶OK** button to finalize the setting.
- 8 Press the **STOP** button to exit the menu screen.

NOTE

- Selecting [On] for [Slate Tone] selects [Off] for:
 - [VCVA] (☞ P.64)
 - [V-Sync. Rec] (☞ P.65)

- 5 Press the **▶OK** button.

Shooting Videos with a Slate Tone

- 1 Connect the camera audio input jack to the earphone jack (🔊) on the voice recorder (📻 P.38).

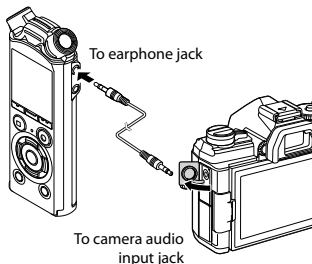

- 2 Press the REC (●) button to prepare for recording.

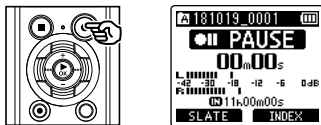

- 3 Press the ►► or ◀◀ button to adjust the recording level.

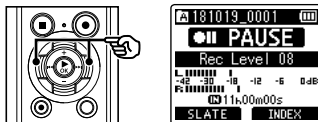

- 4 Press the REC (●) button to start recording.

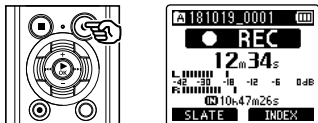

- During recording, the recording indicator light (LED) turns on and [●REC] appears in the display.

- 5 Start filming on the camera.

- For information on filming videos, see the user's manual provided with the camera.

Additions/modifications by the firmware version 1.10

6 Press the F1 (SLATE) button on the voice recorder.

- A beep (slate tone) will be recorded.



8 Press the STOP (■) button when you want to stop recording.

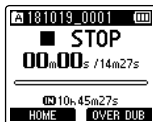
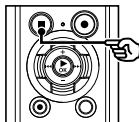

7 End filming on the camera.

NOTE

- The slate tone is recorded to both the video and audio files.
- The slate tone is not output on the voice recorder or the camera's built-in speaker during filming.

TIP

- Having the slate tone waveform available as a marker will help you synchronize the audio and video when using Olympus Workspace to replace the audio originally recorded with the video with the sound file from the voice recorder. For information on downloading Olympus Workspace, visit: <https://support.olympus-imaging.com/owdownload/>
- Third-party editing software can also be used. For more information, see the user's manual provided with the editing software.

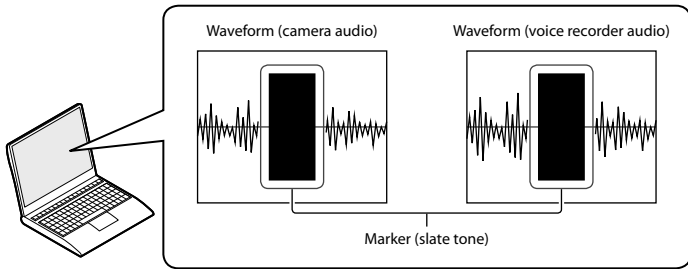

Additions/modifications by the firmware version 1.10

Adjusting Sound Level for Output to the Camera: [Test Tone]

Using a test tone to match output volume to the optimal camera recording level before beginning recording helps prevent crackling and distortion.

LS-P4 model only

- 1 Connect the camera audio input jack to the earphone jack (🔊) on the voice recorder (📄 P.38).

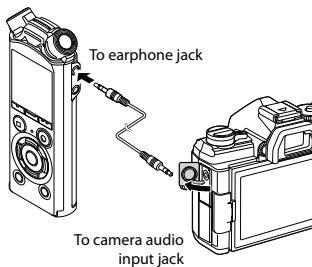

- 2 Press the **MENU/SCENE** button while the voice recorder is in stop mode.
- 3 Press the **+ or -** button to select the **[Rec Menu]** tab.

- 4 Press the **▶OK** button to move the cursor into the list of setting items.
- 5 Press the **+ or -** button to select **[Test Tone]**.

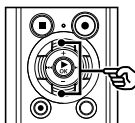

- 6 Press the **▶OK** button.
- 7 Press the **▶OK** button again to sound a test tone.

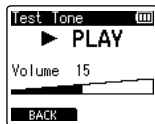
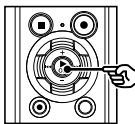

Additions/modifications by the firmware version 1.10

- 8 Adjust the volume using the + or – button.**

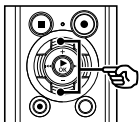

- The volume can be adjusted to a setting between [00] to [30]. The higher the number, the louder the volume.
- If the volume is set too loud, a warning screen may appear.

- 9 Press the STOP (■) button to stop the test tone.**

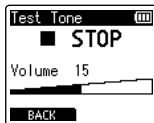
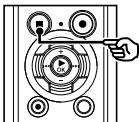

- 10 Press the F1 (BACK) button to return to the menus.**

- 11 Press the STOP (■) button to exit the menu screen.**

- Press and hold the **STOP (■)** button when the voice recorder is stopped to check setting indicators meanings.

NOTE

- Changes to test tone volume also apply to voice recorder playback volume (see P.39).
- The test tone is not output on the voice recorder or the camera's built-in speaker.

TIP

- Noise can be minimized by setting the voice recorder to maximum volume and adjusting the recording level on the camera.

For customers in North and South America:

FCC Notice

- This equipment has been tested and found to comply with the limits for a Class B digital device, pursuant to Part 15 of the FCC Rules. These limits are designed to provide reasonable protection against harmful interference in a residential installation.
- This equipment generates, uses, and can radiate radio frequency energy and, if not installed and used in accordance with the instructions, may cause harmful interference to radio communications.
- However, there is no guarantee that interference will not occur in a particular installation. If this equipment does cause harmful interference to radio or television reception, which can be determined by turning the equipment off and on, the user is encouraged to try to correct the interference by one or more of the following measures:
 - Reorient or relocate the receiving antenna.
 - Increase the separation between the equipment and receiver.
 - Connect the equipment into an outlet on a circuit different from that to which the receiver is connected.
 - Consult the dealer or an experienced radio/TV technician for help.
 - Use only Olympus' supplied cable or AC adapter when you connect the applicable equipment to an external device or a power outlet.

FCC CAUTION

Changes or modifications not expressly approved by the party responsible for compliance could void the user's authority to operate the equipment.

This transmitter must not be co-located or operated in conjunction with any other antenna or transmitter.

This equipment complies with FCC/IC

radiation exposure limits set forth for an uncontrolled environment and meets the FCC radio frequency (RF) Exposure Guidelines in Supplement C to OET65 and RSS-102 of the IC radio frequency (RF) Exposure rules. This equipment has very low levels of RF energy that are deemed to comply without testing of specific absorption ratio (SAR).

For customers in USA

Declaration of Conformity

Model Number: LS-P4/LS-P1

Trade Name: OLYMPUS

Responsible Party: OLYMPUS AMERICA INC.

Address: 3500 Corporate Parkway, P.O. Box 610, Center Valley, PA 18034-0610, U.S.A.

Telephone Number: 484-896-5000

Tested To Comply With FCC Standards FOR HOME OR OFFICE USE

This device complies with Part 15 of FCC Rules and Industry Canada licence-exempt RSS standard(s).

Operation is subject to the following two conditions:

- (1) this device may not cause harmful interference, and
- (2) this device must accept any interference received, including interference that may cause undesired operation of this device.

For customers in CANADA

CAN ICES-3 (B)/NMB-3 (B)

For customers in Europe:



The "CE" mark indicates that this product complies with the European requirements for safety, health, environment and customer protection. CE-mark products are for sale in Europe.



This symbol [crossed-out wheeled bin WEEE Annex IV] indicates separate collection of waste electrical and electronic equipment in the EU countries. Please do not throw the equipment into the domestic refuse. Please use the return and collection systems available in your country for the disposal of this product.



This symbol [crossed-out wheeled bin Directive 2006/66/EC Annex II] indicates separate collection of waste batteries in the EU countries. Please do not throw the batteries into the domestic refuse. Please use the return and collection systems available in your country for the disposal of the waste batteries.



To prevent possible hearing damage, do not listen at high volume levels for long periods.

Hereby, Olympus Corporation declares that the radio equipment type LS-P4 is in compliance with Directive 2014/53/EU.

The full text of the EU declaration of conformity is available at the following internet address:
<http://www.olympus-europa.com/>

OLYMPUS®

OLYMPUS CORPORATION

2951 Ishikawa-machi, Hachioji-shi, Tokyo 192-8507, Japan.

OLYMPUS AMERICA INC.

3500 Corporate Parkway, P.O. Box 610, Center Valley, PA 18034-0610, U.S.A.
Tel. 484-896-5000

Technical Support (USA):

24/7 online automated help:
<http://www.olympusamerica.com/support>
Phone customer support:
Tel.: 1-888-553-4448 (Toll-free)

Our phone customer support is available from 9 am to 9 pm (Monday to Friday) ET
<http://www.olympusamerica.com/contactus>
Olympus software updates can be obtained at:
<http://www.olympusamerica.com/digital>

OLYMPUS EUROPA SE & CO. KG

Premises:

Consumer Product Division
Wendenstrasse 14 - 18, 20097 Hamburg, Germany.
Tel. :+49 40 -23 77 3-0 / Fax +49 40 - 23 07 61

Goods delivery:

Modul H, Willi-Bleicher Str. 36, 52353 Düren, Germany.

Letters:

Postfach 10 49 08, 20034 Hamburg, Germany.

European Technical Customer Support:

Please visit our homepage <http://www.olympus-europa.com>

or call our TOLL FREE NUMBER*: **00800 - 67 10 83 00**

for Austria, Belgium, Czech Republic, Denmark, Finland, France, Germany, Luxemburg, Netherlands, Norway, Poland, Portugal, Russia, Spain, Sweden, Switzerland, United Kingdom.

* Please note some (mobile) phone services / provider do not permit access or request an additional prefix to +800 numbers.

For all not listed European Countries and in case that you can't get connected to the above mentioned number please make use of the following

CHARGED NUMBER: **+ 49 40 - 237 73 899.**

OLYMPUS AUSTRALIA PTY LTD.

Level 4, 97 Waterloo Road, Macquarie Park NSW 2113

Tel: **+61 2 9886 3992**

<http://www.olympus.com.au>

Customer Service Centres:

Australia

Olympus Australia Pty Ltd.

Tel: **1300 659 678**

Fax: **+61 2 9889 7988**

<http://www.olympus.com.au>

New Zealand

Dictation Distributors Ltd.

Tel: **0800 659 678**

Fax: **+64 9 303 3189**

<http://www.dictation.co.nz>

OLYMPUS SINGAPORE PTE. LTD.

491B River Valley Road #12-01/04 Valley Point Office Tower, Singapore 248373

Tel. (65) 6834-0010

<http://www.olympus.com.sg>

OLYMPUS (MALAYSIA) SDN. BHD.

Unit No.10-8, Menara 1MK, Kompleks '1 Mont' Kiara', No.1, Jalan Kiara, Mont' Kiara,

50480 Kuala Lumpur, Malaysia

Tel. (60) 3-6411-0000

<http://www.olympus.com.my>

OLYMPUS HONG KONG AND CHINA LIMITED

L43, Office Tower, Langham Place, 8 Argyle Street, Mongkok, Kowloon, Hong Kong

Tel. (852) 2481-7812

<https://www.olympus.com.hk>

OLYMPUS (THAILAND) CO., LTD.

Imaging Products Division

23/112 Sorachai Building, 27th Floor, Soi Sukhumvit 63 (Ekamai), Sukhumvit Road,

Klongton Nua, Wattana, Bangkok, 10110 Thailand

Tel. (66) 2-787-8200

<http://www.olympusimaging-th.com>