

OLYMPUS[®]

DIGITAL CAMERA

FE-230/X-790
FE-240/X-795

**Basic
Manual**

ENGLISH 2

FRANÇAIS 26

ESPAÑOL 50

PORTUGUÊS 74

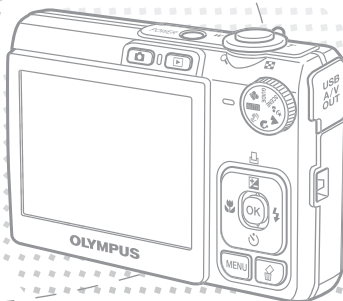
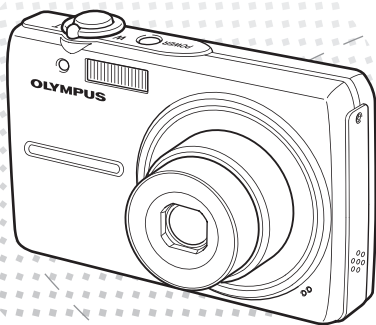

Table of Contents

Gather these items (box contents)	3
Attach the strap	3
Prepare the battery	4
Turn the camera on	5
Set the date and time	6
About the date and time setting screen	6
Set the language	8
Take a picture	9
Review your pictures	10
Erase pictures	10
Basic operation	11
Shooting Mode Buttons	11
Scene Modes	12
Macro Mode	12
Flash Modes	13
Self-Timer	13
Power Save Feature.....	13
Menus and settings	14
Top Menu	14
Erase All Pictures	14
Connecting the camera	15
Playback on a TV	15
Direct Printing (PictBridge).....	16
Transfer images	17
OLYMPUS Master software	19
Specifications	20
Safety Precautions	22

En

- Before using your camera, read this manual carefully to ensure correct use.
- We recommend that you take test shots to get accustomed to your camera before taking important photographs.
- Please observe the safety precautions at the end of this manual.
- The images on the LCD screen and illustrations of the camera used in this manual may differ from the actual product. Unless otherwise specified, the explanation about these illustrations is provided for FE-230/X-790.

Gather these items (box contents)



Digital Camera



Strap

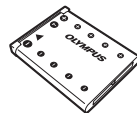

Lithium Ion Battery
(LI-42B)

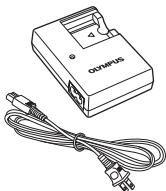

Battery Charger
(LI-40C)



USB Cable

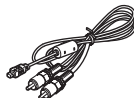

AV Cable



OLYMPUS Master
CD-ROM

En

Items not shown: Advanced Manual (CD-ROM), Basic Manual (this manual), and the Warranty Card. Contents may vary depending on purchase location.

Attach the strap

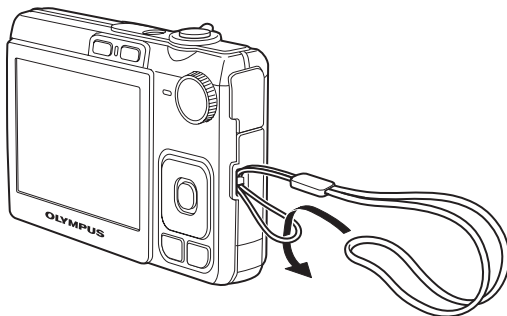

- Pull the strap tight so that it does not come loose.

Prepare the battery

a. Charge the battery.

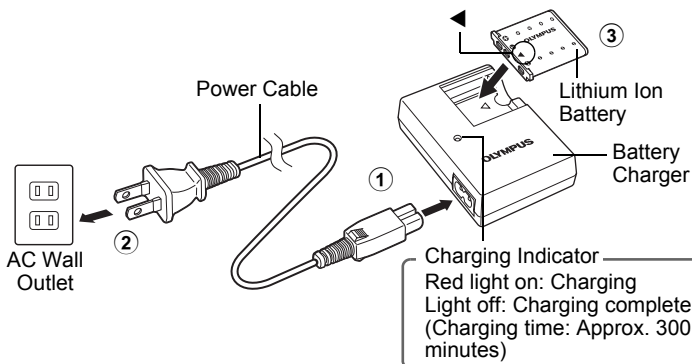

- Battery comes partially charged.

b. Insert the battery in the camera.

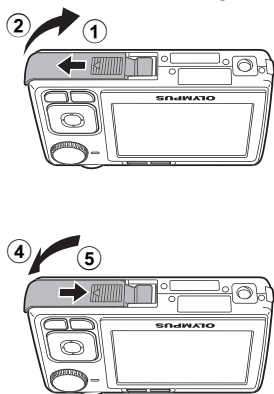

- Insert the battery in the direction indicated by the ▼ mark.

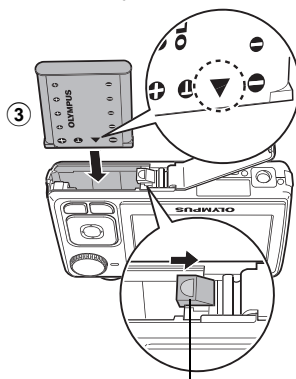

Battery lock knob

- To remove the battery, press the battery lock knob in the direction of the arrow.

- With this camera, you can take pictures without inserting the optional xD-Picture Card™ (hereinafter referred to as “the card”). For details on inserting the card, please refer to the Advanced Manual.

Turn the camera on

This explains how to turn on the camera in shooting mode.

a. Set the mode dial to **AUTO**.

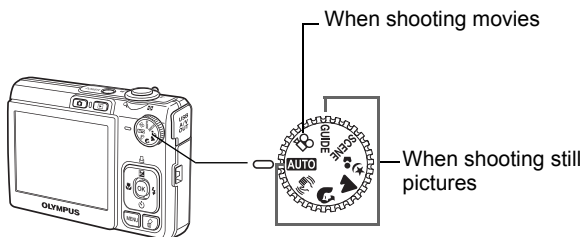



Still picture shooting modes

AUTO For normal shooting.

 This function reduces the blur incurred by a moving subject or camera movement when taking pictures.

 Suitable for taking pictures of people.

 Suitable for taking pictures of a landscape.

 Suitable for taking pictures of people at night.

SCENE Select from 10 available scene modes (FE-240/X-795) or 13 available scene modes (FE-230/X-790), according to the shooting conditions.

GUIDE Use the shooting guide displayed on the screen to shoot pictures according to the situation.



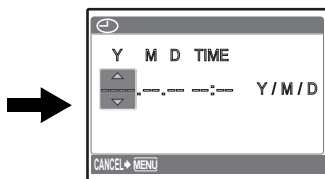
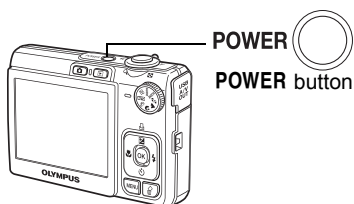

b. Press the **POWER** button.



● This screen is displayed if the date and time are not set.

● To turn off the camera, press the **POWER** button once again.

Hint

The directions of the arrow pad is indicated with     in the supplied instruction manual.

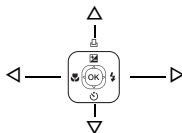

Set the date and time

About the date and time setting screen

En

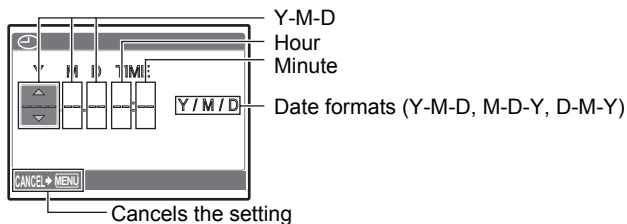

a. Press the and buttons to select [Y].

- The first two digits of the year are fixed.

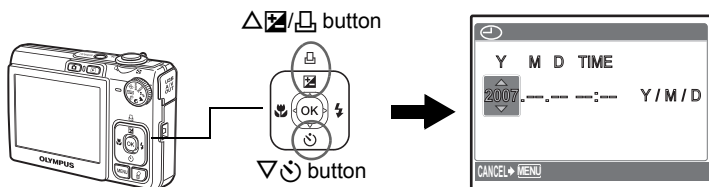

b. Press the button.

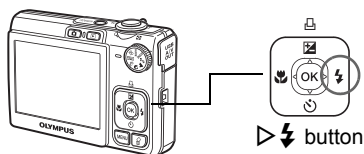

c. Press the and buttons to select [M].

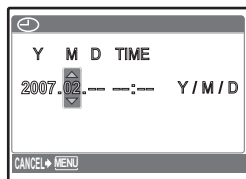

- d. Press the button.
 e. Press the / and buttons to select [D].

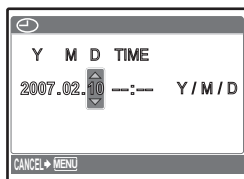

- f. Press the button.
 g. Press the / and buttons to select the hours and minutes.
 • The time is displayed in the 24-hour format.

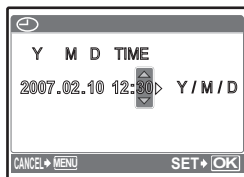

- h. Press the button.
 i. Press the / and buttons to select [Y/M/D].



- j. After all settings have been set, press .
 • For a more accurate setting, press when the time signal hits 00 seconds.

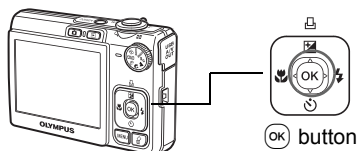

Set the language

- a. Press the MENU button to display the top menu.





MENU button

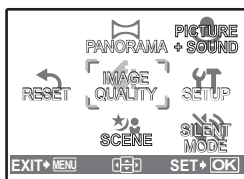



MENU



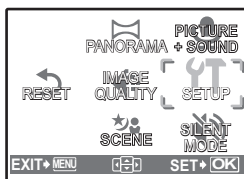



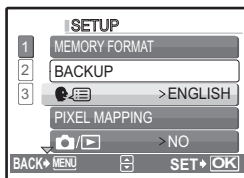

En

- b. Press the  button to select [SETUP], and press .



- c. Press the ,  and  buttons to select , and press .



- d. Press the arrow pad (, , , ) to select a language, and press .

- You can add other languages to your camera with the provided OLYMPUS Master software. Please refer to the Advanced Manual.

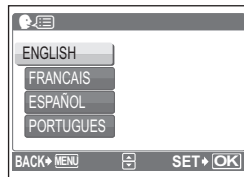

Take a picture

a. Hold the camera.

Horizontal grip

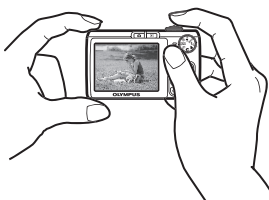
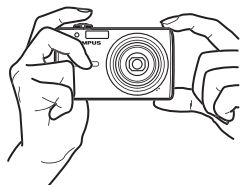

Vertical grip



En

b. Focus.

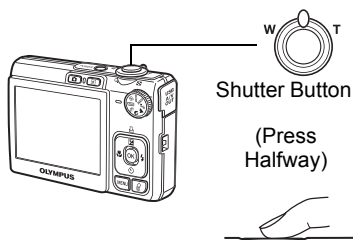

Place this mark over your subject.



The number of pictures that can be taken is displayed.

The green lamp indicates the focus and exposure are locked.

c. Shoot.

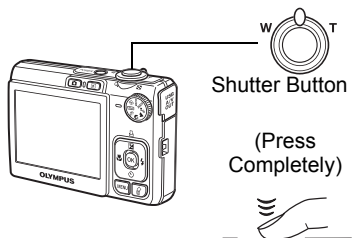

The card access lamp blinks.



Review your pictures

- a. Press the  button.

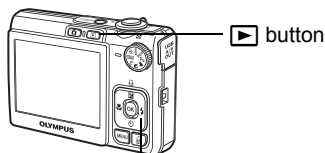

Arrow pad





Displays the next image

Displays the previous image



Erase pictures

- a. Press the  and  buttons to display the picture you want to erase.
- b. Press the  button.

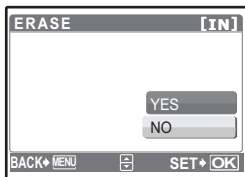
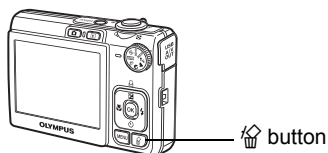

- c. Press the  button, select [YES], and press .

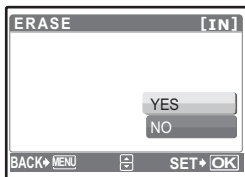
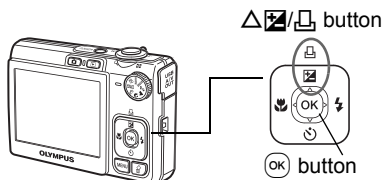

Basic operation

Shooting Mode Buttons

While in shooting mode, use these buttons for quick access to some of the more commonly used features.

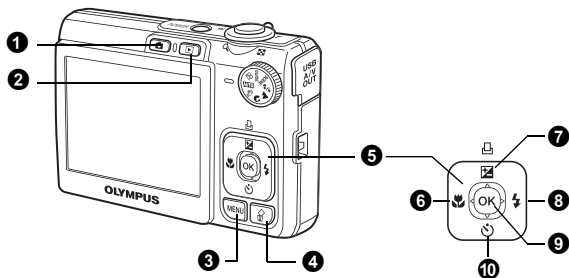

En

- 1** **button (Shooting)**
Selects the shooting mode.
- 2** **button (Playback)**
Selects the playback mode.
- 3** **MENU button**
Displays the top menu.
- 4** **button (Erase)**
Selects the picture you want to erase in playback mode.
- 5** **Arrow pad ($\Delta \nabla \triangleleft \triangleright$)**
Selects scenes, playback pictures and menu items.
- 6** **button (Macro Mode)**
Enables macro or super macro mode for taking close-up pictures.
- 7** **button (Exposure Compensation/Print)**
While in shooting mode, press this button to adjust the exposure compensation value, which affects picture brightness.
- 8** **button (Flash Mode)**
Selects from 4 flash modes - AUTO, (Red-eye reduction), (Fill-in flash), or (Flash off).
- 9** **button (OK)**
Confirms settings.
- 10** **button (Self-timer)**
Sets the self-timer to take the shot approximately 12 seconds after the shutter button is pressed.

Scene Modes

This function allows you to switch the **SCENE** (scene mode) according to the subject.

- 1 Set the mode dial to **SCENE**.

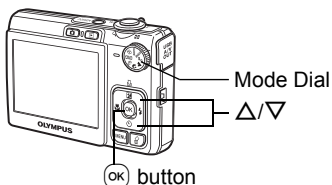
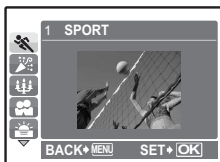

- 2 Press Δ/∇ to select the scene modes and press OK .

Shooting Scene Modes

- SPORT
- SELF PORTRAIT
- BEHIND GLASS
- AUCTION
- UNDER WATER MACRO*¹
- INDOOR
- SUNSET
- CUISINE
- UNDER WATER WIDE1*¹
- CANDLE
- FIREWORKS
- DOCUMENTS
- UNDER WATER WIDE2*¹

*¹ Available for the FE-230/X-790 only.



Macro Mode

- This mode lets you take pictures as close as 10 cm (3.9 in.) with FE-230/X-790, 20 cm (7.9 in.) with FE-240/X-795 to your subject. (at the widest angle)
- Use this mode to take pictures as close as 5 cm (2.0 in.) with FE-230/X-790, 3 cm (1.2 in.) with FE-240/X-795 to your subject. In mode, the position of the zoom lens is fixed.

- 1 Press the \triangleleft button repeatedly to select or and press OK .



Flash Modes

- 1 Press the \triangleright ⚡ button repeatedly to select the flash mode and press OK .
- 2 Press the shutter button halfway.
 - When the flash is set to fire, the ⚡ mark lights.
- 3 Press the shutter button completely to take the picture.

Icon	Flash Mode	Description
No indication	Auto flash	The flash fires automatically in low light or backlight conditions.
	Red-eye reduction flash	The red-eye reduction flash mode significantly reduces this phenomenon by emitting pre-flashes before firing the regular flash.
	Fill-in flash	The flash fires regardless of the available light.
	Flash off	The flash does not fire even in low light conditions.

En

Self-Timer

- 1 Press the ∇  button to select [] and press OK .
- 2 Press the shutter button fully to take the picture.
 - The self-timer lamp lights for approximately 10 seconds after the shutter button is pressed, then starts blinking. After blinking for approximately 2 seconds, the picture is taken.

Self-timer Lamp



Power Save Feature

- To save the battery power, the camera automatically enters sleep mode and stops operating if not used for approximately 3 minutes. Operate the shutter button or zoom lever to reactivate the camera.
- If the camera is not operated for approximately 12 minutes after the camera enters sleep mode, it automatically retracts the lens and turns off. To resume operation, turn on the power again.

Menus and settings

Top Menu

- 1 Press the **MENU** button to display the top menu on the monitor.
- 2 Use the arrow pad ($\Delta \nabla \triangleleft \triangleright$) to select menu items.

En

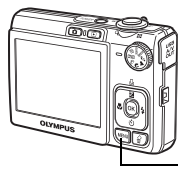

MENU button



Top menu in shooting mode

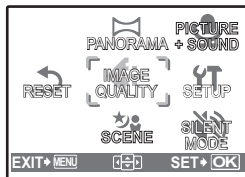

IMAGE QUALITY

Sets image quality and resolution.

PANORAMA

Creates a panoramic picture.

RESET

Resets to the factory default settings.

SCENE

Select a scene according to the subject and shooting condition.

SILENT MODE

Mutes the operation sounds, warning sounds, shutter sound, etc... during shooting and playback.

SETUP

Sets the date and time, language and other settings.

PICTURE+SOUND/MOVIE W/SOUND

Records sound during shooting.

Erase All Pictures

- 1 Press the **MENU** button to display the top menu in playback mode.
- 2 Select [ERASE], [ALL ERASE], and press **OK**.
- 3 Select [YES], and press **OK**.
 - All the pictures are erased.

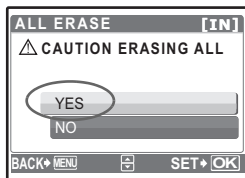

Connecting the camera



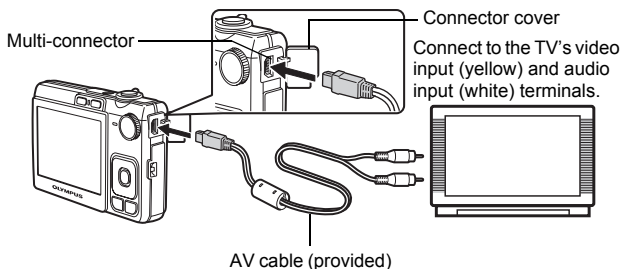

Playback on a TV

Use the AV cable provided with the camera to playback recorded images on your TV. Both still pictures and movies can be played back.

- 1 Make sure that the TV and camera are turned off. Connect the multi-connector on the camera to the video input terminal on the TV using the AV cable.



En

- 2 Turn the TV on and set it to the video input mode.
 - For details on switching to video input, refer to your TV's instruction manual.
- 3 Turn the camera on and press the  button to select the playback mode.
 - The last picture taken is displayed on the TV. Use the arrow pad (   ) to select the picture you want to display.

Direct Printing (PictBridge)

Using the provided USB cable, you may connect your camera directly to a PictBridge compatible printer to make prints. You can print a picture with simple operations.

- 1 In playback mode, display the picture you want to print out on the monitor.
- 2 Connect one end of the provided USB cable into the camera's multi-connector and the other end into the printer's USB connector.

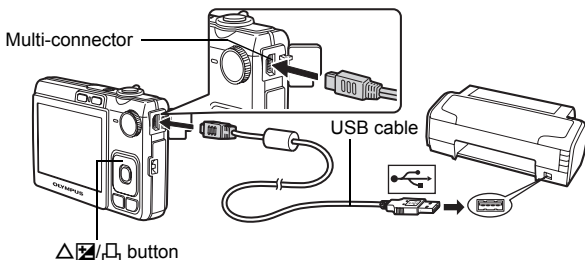

- 3 Press the △ [Print] button.
 - Printing starts.
 - When you are finished, disconnect the USB cable from the camera with the picture selection screen displayed.



Transfer images

a. Install the software

- 1 Insert the OLYMPUS Master CD-ROM.
- 2 **Windows:** Click the "OLYMPUS Master 2" button.
Macintosh: Double-click the "Setup" icon.
- 3 Simply follow the on-screen instructions.



En

b. Connect the camera to the computer

- 1 Connect the camera and computer using the USB cable (provided).
 - The monitor will turn on automatically.

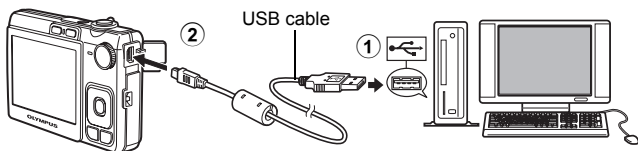

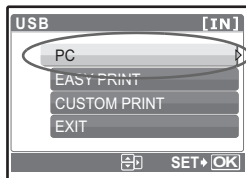

- 2 Select [PC] on the monitor, and press **OK**.



- Your PC will now recognize your camera as a removable storage drive.

c. Transfer images to the computer

- 1 With the camera now connected, open OLYMPUS Master.
- 2 Click “Transfer Images”  on the browse window, and then click “From Camera” .
- 3 Simply follow the on-screen instructions.



En

Tips

- For more detailed information regarding camera setup and usage, please refer to the camera’s “Advanced Manual” provided on CD-ROM.
- For additional assistance, refer to the “Help” file in the OLYMPUS Master software.

OLYMPUS Master software

OLYMPUS Master Software: Use this software to download pictures from the camera, view, organize, retouch, e-mail and print your digital pictures, movies and more!



● System Requirements

OS	Windows 2000 Professional/XP Home Edition/XP Professional/Vista or Mac OS X (v10.3 or later)
CPU	Pentium III 500 MHz/Power PC G3 500 MHz/Intel Core Solo/Duo 1.5 GHz, or later
RAM	256 MB or more
Hard Disk	500 MB or more free space
Connection	USB port/IEEE 1394 port
Monitor	1024 × 768 pixels resolution or more with minimum 65,536 colors (Windows), 32,000 colors (Macintosh)
Other	Internet Explorer 6 or later (Windows), Safari 1.0 or later, QuickTime 6 or later (Macintosh)

En

For the latest support information, visit the Olympus website (<http://www.olympus.com/>)



User Registration

Register your camera when you install OLYMPUS Master to activate your warranty, receive notifications for software and camera firmware updates, and more.

Specifications

● Camera

Product type	: Digital camera (for shooting and displaying)
Recording system	
Still pictures	: Digital recording, JPEG (in accordance with Design rule for Camera File system (DCF))
Applicable standards	: Exif 2.2, Digital Print Order Format (DPOF), PRINT Image Matching III, PictBridge
Sound with still	: Wave format
Movie	: AVI Motion JPEG
Memory	: Internal memory xD-Picture Card (16 MB – 2 GB) (Type H/M, Standard)
Number of effective pixels	: 7,100,000 pixels
Image pickup device	: 1/2.5" CCD (primary color filter), 7,400,000 pixels (gross)
Lens	: FE-230/X-790: Olympus lens 6.3 to 18.9 mm, f3.1 to 5.9 (equivalent to 38 to 114 mm on a 35 mm camera) FE-240/X-795: Olympus lens 6.4 to 32 mm, f3.3 to 5.0 (equivalent to 38 to 190 mm on a 35 mm camera)
Photometric system	: Digital ESP metering
Shutter speed	: 4 to 1/2000 sec.
Shooting range	: FE-230/X-790: 0.6 m (2.0 ft.) to ∞ (W), 1.0 m (3.2 ft.) to ∞ (T) (normal) 0.1 m (0.3 ft.) to ∞ (W), 0.6 m (2.0 ft.) to ∞ (T) (macro mode) 0.05 m (0.2 ft.) (super macro mode) FE-240/X-795: 0.7 m (2.3 ft.) to ∞ (normal) 0.2 m (0.7 ft.) to ∞ (W), 0.6 m (2.0 ft.) to ∞ (T) (macro mode) 0.03 m (0.1 ft.) (super macro mode)
Monitor	: 2.5" TFT color LCD display, 115,000 pixels
Outer connector	: USB connector, A/V OUT jack (multi-connector)
Automatic calendar system	: 2000 up to 2099
Operating environment	
Temperature	: 0°C to 40°C (32°F to 104°F) (operation)/ -20°C to 60°C (-4°F to 140°F) (storage)
Humidity	: 30% to 90% (operation)/10% to 90% (storage)
Power supply	: One Olympus lithium ion battery (LI-42B/LI-40B)

Dimensions	: FE-230/X-790: 90.5 mm (W) × 55.0 mm (H) × 16.5 mm (D) (3.6 × 2.2 × 0.6 in.) (excluding protrusions) FE-240/X-795: 93.5 mm (W) × 56.0 mm (H) × 20.0 mm (D) (3.7 × 2.2 × 0.8 in.) (excluding protrusions)
Weight	: FE-230/X-790: 105 g (3.7 oz) without battery and card FE-240/X-795: 115 g (4.0 oz) without battery and card

● **Lithium ion battery (LI-42B)**

Product type	: Lithium ion rechargeable battery
Standard voltage	: DC 3.7 V
Standard capacity	: 740 mAh
Battery life	: Approx. 300 full charges (varies on usage)
Operating environment	
Temperature	: 0°C to 40°C (32°F to 104°F) (charging)/ -10°C to 60°C (14°F to 140°F) (operation)/ -20°C to 35°C (-4°F to 95°F) (storage)
Dimensions	: 31.5 × 39.5 × 6 mm (1.2 × 1.5 × 0.2 in.)
Weight	: Approx. 15 g (0.5 oz)

En

● **Battery charger (LI-40C)**

Power requirements	: AC 100 to 240 V (50 to 60 Hz) 3.2 VA (100 V) to 5.0 VA (240 V)
Output	: DC 4.2 V, 200 mA
Charging time	: Approx. 300 min.
Operating environment	
Temperature	: 0°C to 40°C (32°F to 104°F) (operation)/ -20°C to 60°C (-4°F to 140°F) (storage)
Dimensions	: 62 × 23 × 90 mm (2.4 × 0.9 × 3.5 in.)
Weight	: Approx. 65 g (2.3 oz)

Design and specifications subject to change without notice.

Safety Precautions

En



CAUTION

RISK OF ELECTRIC SHOCK
DO NOT OPEN



CAUTION: TO REDUCE THE RISK OF ELECTRICAL SHOCK, DO NOT REMOVE COVER (OR BACK). NO USER-SERVICEABLE PARTS INSIDE. REFER SERVICING TO QUALIFIED OLYMPUS SERVICE PERSONNEL.



An exclamation mark enclosed in a triangle alerts you to important operating and maintenance instructions in the documentation provided with the product.



DANGER

If the product is used without observing the information given under this symbol, serious injury or death may result.



WARNING

If the product is used without observing the information given under this symbol, injury or death may result.



CAUTION

If the product is used without observing the information given under this symbol, minor personal injury, damage to the equipment, or loss of valuable data may result.

WARNING!

TO AVOID THE RISK OF FIRE OR ELECTRICAL SHOCK, NEVER DISASSEMBLE, EXPOSE THIS PRODUCT TO WATER OR OPERATE IN A HIGH HUMIDITY ENVIRONMENT.

General Precautions

- Read All Instructions** — Before you use the product, read all operating instructions. Save all manuals and documentation for future reference.
- Cleaning** — Always unplug this product from the wall outlet before cleaning. Use only a damp cloth for cleaning. Never use any type of liquid or aerosol cleaner, or any type of organic solvent to clean this product.
- Attachments** — For your safety, and to avoid damaging the product, use only accessories recommended by Olympus.
- Water and Moisture** — For precautions on products with weatherproof designs, read the weatherproofing sections.
- Location** — To avoid damage to the product, mount the product securely on a stable tripod, stand, or bracket.
- Power Source** — Connect this product only to the power source described on the product label.
- Foreign Objects** — To avoid personal injury, never insert a metal object into the product.
- Heat** — Never use or store this product near any heat source such as a radiator, heat register, stove, or any type of equipment or appliance that generates heat, including stereo amplifiers.

Handling the Camera



WARNING

- **Do not use the camera near flammable or explosive gases.**
- **Do not use the flash on people (infants, small children, etc.) at close range.**
 - You must be at least 1 m (3 ft.) away from the faces of your subjects. Firing the flash too close to the subject's eyes could cause a momentary loss of vision.
 - Keep young children and infants away from the camera.
 - Always use and store the camera out of the reach of young children and infants to prevent the following dangerous situations which could cause serious injury:
 - Becoming entangled in the camera strap, causing strangulation.
 - Accidentally swallowing the battery, cards or other small parts.
 - Accidentally firing the flash into their own eyes or those of another child.
 - Accidentally being injured by the moving parts of the camera.
- **Do not look at the sun or strong lights with the camera.**
- **Do not use or store the camera in dusty or humid places.**
- **Do not cover the flash with a hand while firing.**



CAUTION

- **Stop using the camera immediately if you notice any unusual odors, noise, or smoke around it.**
 - Never remove the batteries with bare hands, which may cause a fire or burn your hands.
- **Never hold or operate the camera with wet hands.**
- **Do not leave the camera in places where it may be subject to extremely high temperatures.**
 - Doing so may cause parts to deteriorate and, in some circumstances, cause the camera to catch fire. Do not use the charger if it is covered (such as a blanket). This could cause overheating, resulting in fire.
- **Handle the camera with care to avoid getting a low-temperature burn.**
 - When the camera contains metal parts, overheating can result in a low-temperature burn. Pay attention to the following:
 - When used for a long period, the camera will get hot. If you hold on to the camera in this state, a low-temperature burn may be caused.
 - In places subject to extremely cold temperatures, the temperature of the camera's body may be lower than the environmental temperature. If possible, wear gloves when handling the camera in cold temperatures.
- **Be careful with the strap.**
 - Be careful with the strap when you carry the camera. It could easily catch on stray objects - and cause serious damage.

Battery Handling Precautions

Follow these important guidelines to prevent batteries from leaking, overheating, burning, exploding, or causing electrical shocks or burns.

DANGER

- The camera uses a lithium ion battery specified by Olympus. Charge the battery with the specified charger. Do not use any other chargers.
- Never heat or incinerate batteries.
- Take precautions when carrying or storing batteries to prevent them from coming into contact with any metal objects such as jewelry, pins, fasteners, etc.
- Never store batteries where they will be exposed to direct sunlight, or subjected to high temperatures in a hot vehicle, near a heat source, etc.
- To prevent causing battery leaks or damaging their terminals, carefully follow all instructions regarding the use of batteries. Never attempt to disassemble a battery or modify it in any way, by soldering, etc.
- If battery fluid gets into your eyes, flush your eyes immediately with clear, cold running water and seek medical attention immediately.
- Always store batteries out of the reach of small children. If a child accidentally swallows a battery, seek medical attention immediately.

WARNING

- Keep batteries dry at all times.
- To prevent batteries from leaking, overheating, or causing a fire or explosion, use only batteries recommended for use with this product.
- Insert the battery carefully as described in the operating instructions.
- If rechargeable batteries have not been recharged within the specified time, stop charging them and do not use them.
- Do not use a battery if it is cracked or broken.
- If a battery leaks, becomes discolored or deformed, or becomes abnormal in any other way during operation, stop using the camera.
- If a battery leaks fluid onto your clothing or skin, remove the clothing and flush the affected area with clean, running cold water immediately. If the fluid burns your skin, seek medical attention immediately.
- Never subject batteries to strong shocks or continuous vibration.

CAUTION

- Before loading, always inspect the battery carefully for leaks, discoloration, warping, or any other abnormality.
- The battery may become hot during prolonged use. To avoid minor burns, do not remove it immediately after using the camera.
- Always unload the battery from the camera before storing the camera for a long period.

For customers in North and South America

For customers in USA

Declaration of Conformity

Model Number : FE-230/X-790

FE-240/X-795

Trade Name : OLYMPUS

Responsible Party : OLYMPUS IMAGING AMERICA INC.

Address : 3500 Corporate Parkway, P.O. Box 610, Center Valley,

PA 18034-0610, U.S.A.

Telephone Number : 484-896-5000

Tested To Comply With FCC Standards

FOR HOME OR OFFICE USE

This device complies with Part 15 of the FCC rules. Operation is subject to the following two conditions:

(1) This device may not cause harmful interference.

(2) This device must accept any interference received, including interference that may cause undesired operation.

For customers in Canada

This Class B digital apparatus meets all requirements of the Canadian Interference-Causing Equipment Regulations.

En

Trademarks

- IBM is a registered trademark of International Business Machines Corporation.
- Microsoft and Windows are registered trademarks of Microsoft Corporation.
- Macintosh is a trademark of Apple Computer Inc.
- xD-Picture Card™ is a trademark.
- All other company and product names are registered trademarks and/or trademarks of their respective owners.
- The standards for camera file systems referred to in this manual are the "Design Rule for Camera File System/DCF" standards stipulated by the Japan Electronics and Information Technology Industries Association (JEITA).

Table des matières

Réunissez ces éléments (contenu de la boîte)	27
Attachez la courroie	27
Préparer la batterie	28
Allumer l'appareil photo	29
Régler la date et l'heure	30
A propos de l'écran de réglage de la date et de l'heure	30
Régler la langue	32
Prendre une photo	33
Vérifier les images	34
Effacer des photos	34
Fonctionnement de base	35
Touches du mode prise de vue	35
Modes de scène	36
Mode gros plan	36
Modes flash	37
Retardateur	37
Fonctionnalité d'économie d'énergie	37
Menus et réglages	38
Menu principal	38
Effacement de toutes les photos	38
Connexion de l'appareil photo	39
Affichage sur un téléviseur	39
Impression directe (PictBridge)	40
Transfert d'images	41
Logiciel OLYMPUS Master	43
Caractéristiques	44
Précautions de sécurité	46

- Avant d'utiliser votre appareil photo, lisez attentivement ce manuel pour garantir une utilisation correcte.
- Nous vous recommandons de prendre des photos-test pour vous habituer à votre appareil avant de commencer à prendre de vraies photos.
- Veillez à ce que les mesures de sécurité présentées à la fin de ce manuel soit respectées.
- Les images sur l'écran ACL et les illustrations de l'appareil photo figurant dans ce manuel peuvent différer de celles du produit. Sauf indication contraire, les explications relatives à ces illustrations sont fournies dans les guides relatifs aux modèles FE-230/X-790.

Réunissez ces éléments (contenu de la boîte)



Appareil photo numérique



Courroie

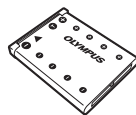

Batterie au lithium-ion (LI-42B)

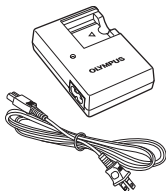

Chargeur de batterie (LI-40C)



Câble USB

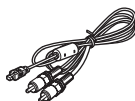

Câble AV



CD-ROM OLYMPUS Master

Fr

Éléments non illustrés : Manuel Avancé (CD-ROM), Manuel de Base (présent manuel), carte de garantie. Le contenu est susceptible de varier en fonction de l'endroit où l'appareil est acheté.

Attachez la courroie

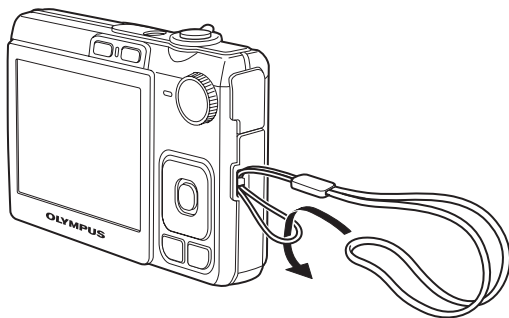

- Tendez la courroie afin qu'elle ne soit pas relâchée.

Préparer la batterie

a. Chargez la batterie.

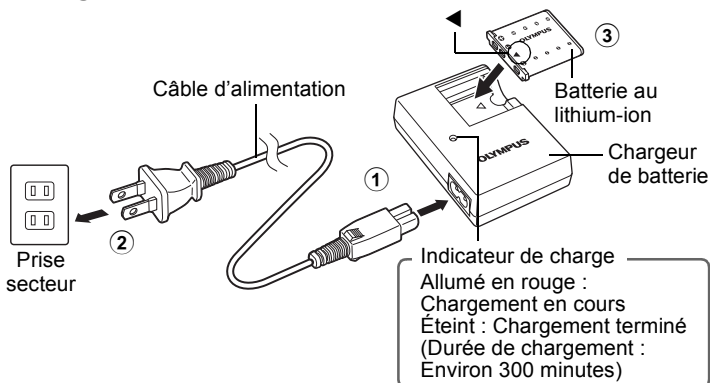

- La batterie est livrée en partie chargée.

b. Insérez la batterie dans l'appareil photo.

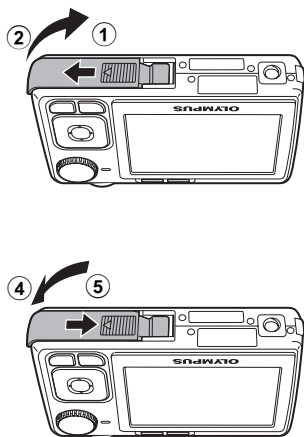

- Insérez la batterie dans le sens indiqué par le symbole ▼.

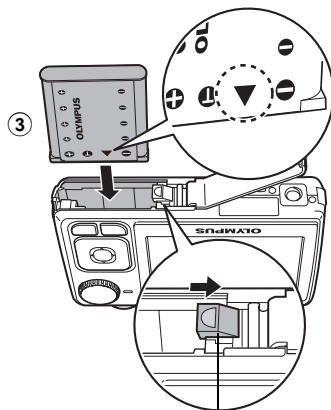

- Bouton de verrouillage de la batterie
- Pour retirer la batterie, appuyez sur le bouton de verrouillage de la batterie dans le sens indiqué par la flèche.

- Avec cet appareil photo, vous pouvez prendre des photos sans insérer la xD-Picture Card™ en option (appelée ci-après "la carte"). Pour plus d'informations sur l'insertion de la carte, reportez-vous au Manuel Avancé.

Régler la date et l'heure

A propos de l'écran de réglage de la date et de l'heure

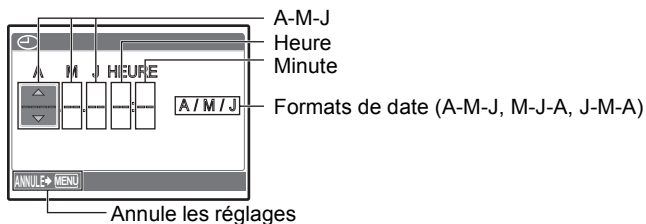

Fr

a. Appuyez sur les touches Δ et ∇ pour sélectionner [A].

- Les deux premiers chiffres de l'année sont fixes.

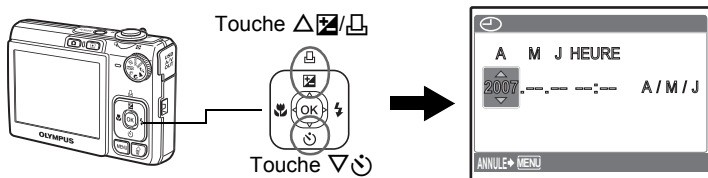

b. Appuyez sur la touche \triangleright .

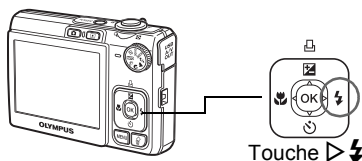

c. Appuyez sur les touches Δ et ∇ pour sélectionner [M].

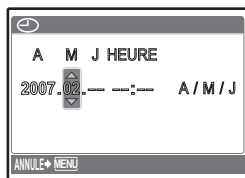

- d. Appuyez sur la touche \triangleright \blacklightning .
- e. Appuyez sur les touches \triangle \square / \square et ∇ \smile pour sélectionner [J].

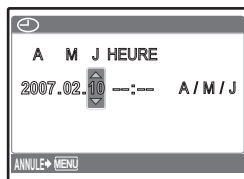

- f. Appuyez sur la touche \triangleright \blacklightning .
- g. Appuyez sur les touches \triangle \square / \square et ∇ \smile pour sélectionner les heures et les minutes.
- L'heure est affichée au format 24 heures.



Fr

- h. Appuyez sur la touche \triangleright \blacklightning .
- i. Appuyez sur les touches \triangle \square / \square et ∇ \smile pour sélectionner [A/M/J].



- j. Une fois que vous avez paramétré tous ces réglages, appuyez sur OK .

- Pour un réglage plus précis, appuyez sur OK lorsque l'horloge franchit 00 seconde.

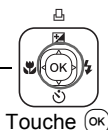
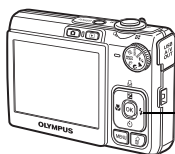

Régler la langue

- a. Appuyez sur la touche **MENU** pour afficher le menu principal.

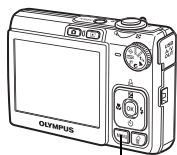

Touche **MENU**

MENU

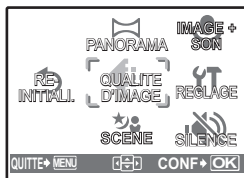

Fr

- b. Appuyez sur la touche **▶⚡** pour sélectionner **[REGLAGE]** et appuyez sur **(OK)**.

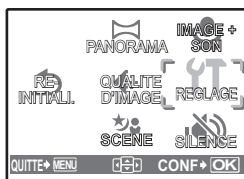

- c. Appuyez sur les touches **△▶/▣** et **▽⌚** pour sélectionner **[REGLAGE]**, puis appuyez sur **(OK)**.

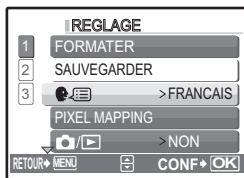

- d. Appuyez sur la molette de défilement (**△▽◀▶**) pour sélectionner une langue, puis appuyez sur **(OK)**.

- Vous pouvez ajouter d'autres langues à votre appareil à l'aide du logiciel OLYMPUS Master fourni. Reportez-vous au Manuel Avancé.



Prendre une photo

a. Tenez l'appareil photo.

Tenue horizontale

Tenue verticale

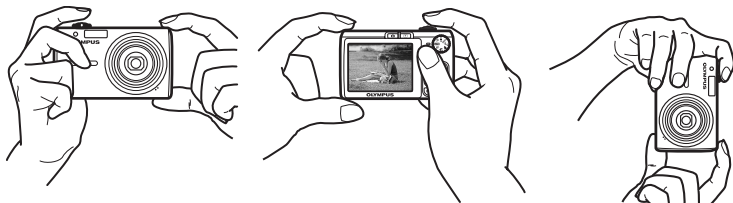

Fr

b. Effectuez la mise au point.

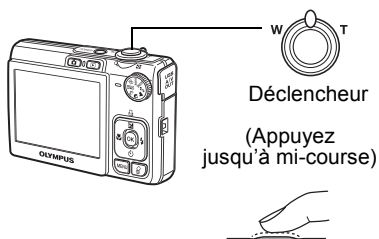

Placez cette marque sur votre sujet.



Le nombre de photos pouvant être prises est affiché.

Le voyant vert indique que la mise au point et l'exposition sont verrouillées.

c. Prenez la photo.

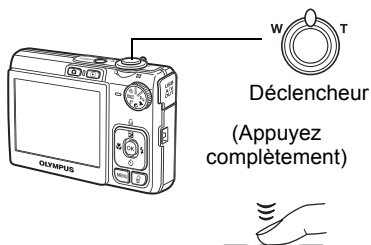

Voyant d'accès de carte.



Vérifier les images

a. Appuyez sur la touche .

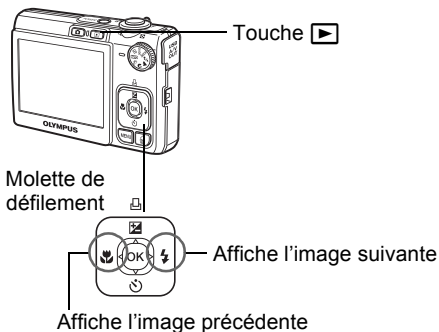

Effacer des photos

a. Appuyez sur les touches   et   pour afficher l'image que vous voulez effacer.

b. Appuyez sur la touche .

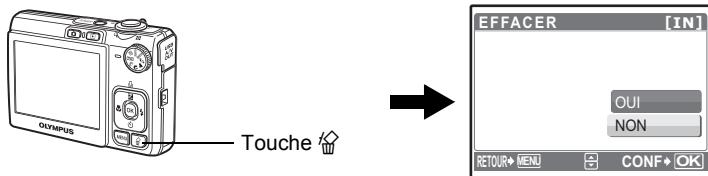

c. Appuyez sur la touche   , sélectionnez [OUI], et appuyez sur .

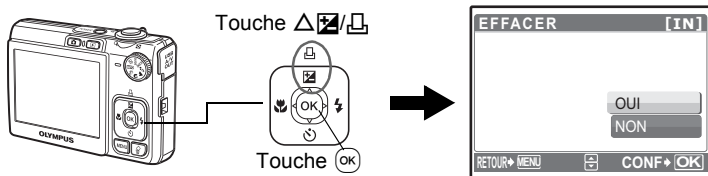







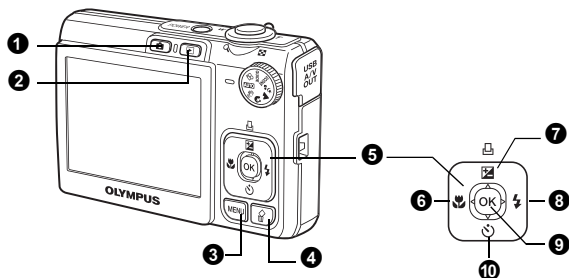









Fonctionnement de base

Touches du mode prise de vue

Lorsque vous êtes en mode prise de vue, ces touches vous permettent d'accéder rapidement à certaines des fonctions les plus utilisées.



Fr

- 1 Touche  (Prise de vue)**
Sélectionne le mode de prise de vue.
- 2 Touche  (Affichage)**
Sélectionne le mode d'affichage.
- 3 Touche MENU**
Affiche le menu principal.
- 4 Touche  (Effacement)**
Sélectionne l'image que vous voulez supprimer en mode d'affichage.
- 5 Molette de défilement (   )**
Sélectionne des scènes, des images affichées et des éléments de menu.
- 6 Touche  (Mode gros plan)**
Active le mode gros plan ou super gros plan pour la prise de photos rapprochées.
- 7 Touche    (compensation d'exposition/impression)**
En mode prise de vue, appuyez sur cette touche pour régler la valeur de compensation d'exposition qui modifie la luminosité de la photo.
- 8 Touche  (Mode flash)**
Sélectionne un des quatre modes de flash - AUTO,  (Atténuant l'effet yeux rouges),  (Flash d'appoint), ou  (Flash désactivé).
- 9 Touche  (OK)**
Confirme les réglage.
- 10 Touche  (Retardateur)**
Sélectionne le retardateur pour retarder la prise de vue d'environ 12 secondes une fois que le déclencheur a été enfoncé.

Modes de scène

Cette fonction vous permet de sélectionner le mode **SCENE** (scène) en fonction du sujet.

- 1 Amenez la molette mode sur **SCENE**.

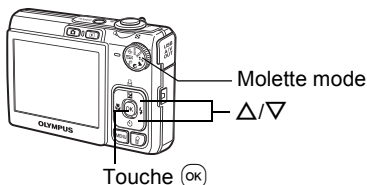
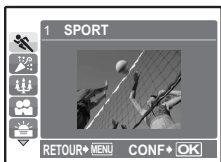

- 2 Appuyez sur Δ/∇ pour sélectionner des modes de scène et appuyez sur OK .

Modes de scène de prise de vue

- SPORT
- AUTO PORTRAIT
- VITRINE
- ENCHÈRE
- SOUS-MARIN MACRO*1
- INTERIEUR
- COUCHER DE SOLEIL
- CUISINE
- SOUS-MARIN LARGE1*1
- BOUGIE
- FEUX D'ARTIFICES
- DOCUMENTS
- SOUS-MARIN LARGE2*1

*1 Uniquement disponible pour le FE-230/X-790.



Mode gros plan

- Ce mode vous permet de prendre des photos à une distance de 10 cm (modèle FE-230/X-790) ou de 20 cm (modèle FE-240/X-795). (avec le plus grand angle)
- Ce mode vous permet de prendre des photos à une distance de 5 cm (modèle FE-230/X-790) ou de 3 cm (modèle FE-240/X-795). En mode s, la position du zoom est fixe.

- 1 Appuyez plusieurs fois sur la touche \triangleleft pour sélectionner [] ou [] et appuyez sur OK .

Modes flash

- 1 Appuyez plusieurs fois sur la touche $\triangleright \text{⚡}$ pour sélectionner le mode de flash et appuyez sur OK .
- 2 Appuyez sur le déclencheur jusqu'à mi-course.
 - Lorsque le flash est réglé pour se déclencher, l'indication ⚡ s'allume.
- 3 Enfoncez complètement le déclencheur pour prendre la photo.

Icône	Mode flash	Description
Aucune indication	Flash automatique	Le flash se déclenche automatiquement lorsque l'éclairage est faible ou à contre-jour.
	Flash atténuant l'effet "yeux rouges"	Ce mode permet d'atténuer considérablement l'effet "yeux rouges" en émettant une série de pré-éclairs avant de déclencher le flash principal.
	Flash d'appoint	Le flash se déclenche quelles que soient les conditions d'éclairage.
	Flash désactivé	Le flash ne se déclenche pas, même dans des situations de faible éclairage.

Fr

Retardateur

- 1 Appuyez sur la touche $\nabla \text{⌚}$ pour sélectionner $[\text{⌚}]$ et appuyez sur OK .
- 2 Enfoncez complètement le déclencheur pour prendre la photo.
 - Le voyant du retardateur s'allume pendant environ 10 secondes après que le déclencheur ait été enfoncé, puis il clignote. La photo est prise après environ 2 secondes de clignotement.

Voyant du retardateur



Fonctionnalité d'économie d'énergie

- Pour économiser l'énergie de la batterie, l'appareil photo passe automatiquement en mode veille et cesse de fonctionner après 3 minutes d'inactivité environ. Actionnez le déclencheur ou le levier de zoom pour réactiver l'appareil photo.
- Une fois qu'il est entré en mode veille, si l'appareil n'est toujours pas utilisé au bout de 12 minutes, l'objectif se rétracte automatiquement et l'appareil s'éteint. Pour l'utiliser à nouveau, remettez-le sous tension.

Menus et réglages

Menu principal

- 1 Appuyez sur la touche **MENU** pour afficher le menu principal à l'écran.
- 2 Utilisez la molette de défilement ($\Delta \nabla \triangleleft \triangleright$) pour sélectionner des éléments de menu.

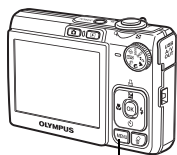

Touche **MENU**

Menu principal en mode prise de vue

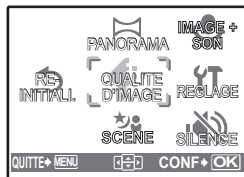

QUALITE D'IMAGE

Définit la qualité de l'image et la résolution.

PANORAMA

Crée une image panoramique.

REINITIALI.

Rétablit les réglages d'usine par défaut.

SCENE

Sélectionnez une scène en fonction du sujet et des conditions de prise de vue.

SILENCE

Désactive le son de fonctionnement, d'avertissement, du déclencheur, etc. en mode prise de vue et d'affichage.

REGLAGE

Définit la date et l'heure, la langue et d'autres paramètres.

IMAGE + SON/VIDEO AVEC SON

Permet d'enregistrer des sons lors de la prise de vue.

Effacement de toutes les photos

- 1 Appuyez sur la touche **MENU** pour afficher le menu principal en mode d'affichage.
- 2 Sélectionnez [EFFACER], [TOUT EFFAC] et appuyez sur **OK**.
- 3 Sélectionnez [OUI] et appuyez sur **OK**.
 - Toutes les images sont effacées.



Connexion de l'appareil photo



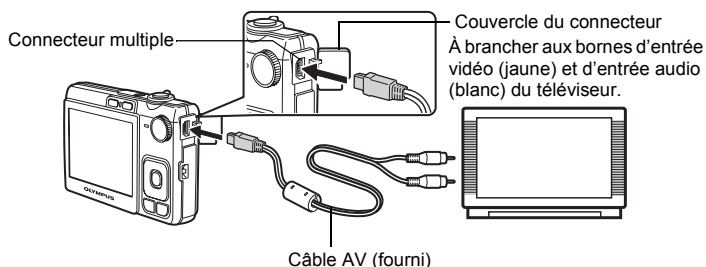

Affichage sur un téléviseur

Utilisez le câble AV fourni avec l'appareil photo pour visualiser les images enregistrées directement sur votre téléviseur. Vous pouvez lire ainsi à la fois les images fixes et les vidéos.

- 1 Assurez-vous que le téléviseur et l'appareil photo sont éteints. Branchez le connecteur multiple de l'appareil photo à la prise d'entrée vidéo du téléviseur avec le câble AV.



Fr

- 2 Allumez le téléviseur et mettez-le en mode entrée vidéo.
 - Pour en savoir plus sur la commutation de l'entrée vidéo, veuillez consulter le manuel du téléviseur.
- 3 Allumez l'appareil photo et appuyez sur la touche  pour sélectionner le mode d'affichage.
 - La dernière photo prise est affichée sur le téléviseur. Utilisez la molette de défilement (   ) pour sélectionner la photo que vous voulez afficher.

Impression directe (PictBridge)

A l'aide du câble USB fourni, vous pouvez connecter votre appareil photo directement à une imprimante compatible PictBridge pour effectuer des impressions. Vous pouvez imprimer facilement des images.

- 1 En mode d'affichage, affichez la photo que vous souhaitez imprimer sur l'écran ACL.
- 2 Connectez une des extrémités du câble USB dans le connecteur multiple de l'appareil photo et l'autre dans le connecteur USB de l'imprimante.

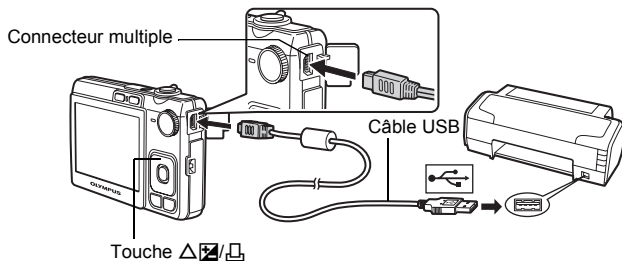

- 3 Appuyez sur la touche Δ/☒/☐.
 - L'impression démarre.
 - Lorsque l'impression est terminée, déconnectez le câble USB de l'appareil photo. L'écran de sélection des photos s'affiche.



Transfert d'images

a. Installez le logiciel

- 1 Insérez le CD-ROM OLYMPUS Master.
- 2 **Windows:** Cliquez sur la touche "OLYMPUS Master 2".
Macintosh: Double-cliquez sur l'icône "Setup".
- 3 Suivez simplement les instructions à l'écran.

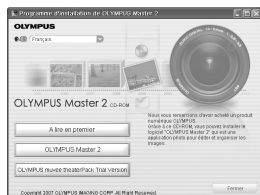

b. Connectez l'appareil photo à l'ordinateur

Fr

- 1 Connectez l'appareil photo et l'ordinateur à l'aide du câble USB (fourni).
 - L'écran ACL s'allume automatiquement.

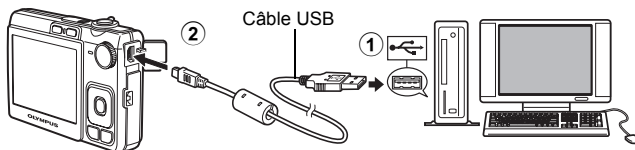

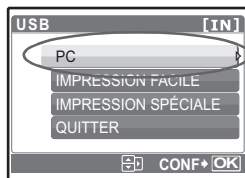

- 2 Sélectionnez [PC] à l'écran ACL et appuyez sur **OK**.



- Votre PC reconnaît maintenant votre appareil photo comme unité de stockage amovible.

c. Transférez les images vers l'ordinateur

- 1 Gardez votre appareil photo connecté, puis ouvrez OLYMPUS Master.
- 2 Cliquez sur "Transférer des images"  dans la fenêtre Parcourir, puis cliquez sur "Depuis l'appareil photo"  .



- 3 Suivez simplement les instructions à l'écran.

Fr

Conseils

- Pour des informations plus détaillées concernant la configuration et l'utilisation de l'appareil photo, veuillez consulter le "Manuel Avancé" de l'appareil photo fourni sur le CD-ROM.
- Pour plus d'informations, consultez le fichier "Aide" du logiciel OLYMPUS Master.

Logiciel OLYMPUS Master

Logiciel OLYMPUS Master : Utilisez ce logiciel pour télécharger des photos à partir de l'appareil photo, pour afficher, organiser, retoucher, envoyer par courrier électronique et imprimer vos photos et vidéos numériques, etc.



● Configurations système minimales

SE	Windows 2000 Professional/XP Home Edition/XP Professional/Vista ou Mac OS X (10.3 ou version ultérieure)
UC	Pentium III 500 MHz/Power PC G3 500 MHz/Intel Core Solo/Duo 1.5 GHz, ou ultérieur
RAM	256 Mo ou plus
Disque dur	500 Mo ou plus d'espace disque
Connexion	Port USB/port IEEE 1394
Écran ACL	Résolution de 1024 × 768 pixels ou plus avec un minimum de 65.536 couleurs (Windows), 32.000 couleurs (Macintosh)
Autres	Internet Explorer 6 ou ultérieur (Windows), Safari 1.0 ou ultérieur, QuickTime 6 ou ultérieur (Macintosh)

Pour obtenir les dernières informations relatives à la prise en charge, consultez le site Web d'Olympus (<http://www.olympus.com/>)



Enregistrement de l'utilisateur

Enregistrez votre appareil photo lorsque vous installez OLYMPUS Master pour activer la garantie, recevoir des notifications pour le logiciel et les mises à jour de micro-logiciels et plus encore.

Fr

Caractéristiques

● Appareil photo

Type de produit	: Appareil photo numérique (prise de vue et affichage)
Système d'enregistrement	
Photos	: Enregistrement numérique, JPEG (conforme à la norme DCF (Design rule for Camera File system))
Normes applicables	: Exif 2.2, Digital Print Order Format (DPOF), PRINT Image Matching III, PictBridge
Image fixe avec son	: Format Wave
Vidéo	: AVI Motion JPEG
Mémoire	: Mémoire interne xD-Picture Card (16 Mo à 2 Go) (Type H/M, Standard)
Nombre de pixels effectifs	: 7.100.000 de pixels
Capteur d'image	: CCD (filtre de couleur primaire) de 1/2,5" 7.400.000 pixels (brut)
Objectif	: FE-230/X-790: Objectif Olympus 6,3 mm à 18,9 mm, f3,1 à 5,9 (équivalent à un objectif de 38 mm à 114 mm sur un appareil photo de 35 mm) FE-240/X-795: Objectif Olympus 6,4 mm à 32 mm, f3,3 à 5,0 (équivalent à un objectif de 38 mm à 190 mm sur un appareil photo de 35 mm)
Système de mesure	: Mesure ESP numérique
Vitesse d'obturation	: 4 à 1/2000 sec.
Portée de prise de vue	: FE-230/X-790: 0,6 m à ∞ (W), 1,0 m à ∞ (T) (normal) 0,1 m à ∞ (W), 0,6 m à ∞ (T) (mode gros plan) 0,05 m pour (mode super gros plan) FE-240/X-795: 0,7 m à ∞ (normal), 0,2 m à ∞ (W), 0,6 m à ∞ (T) (mode gros plan) 0,03 m (mode super gros plan)
Écran ACL	: Écran couleur à cristaux liquides TFT de 2,5", 115.000 pixels
Connecteurs externes	: Connecteur USB, prise OUT A/V (connecteur multiple)
Calendrier automatique	: de 2000 à 2099
Conditions de fonctionnement	
Température	: 0°C à 40°C (fonctionnement)/ -20°C à 60°C (stockage)
Humidité	: 30% à 90% (fonctionnement)/10% à 90% (stockage)
Alimentation	: Une batterie au lithium-ion Olympus (LI-42B/LI-40B)

Dimensions	: FE-230/X-790: 90,5 mm (P) × 55,0 mm (H) × 16,5 mm (D) (hors saillies) FE-240/X-795: 93,5 mm (P) × 56,0 mm (H) × 20,0 mm (D) (hors saillies)
Poids	: FE-230/X-790: 105 g sans la batterie et la carte FE-240/X-795: 115 g sans la batterie et la carte

● Batterie au lithium-ion (LI-42B)

Type de produit	: Batterie au lithium-ion rechargeable
Tension standard	: 3,7 V CC
Capacité standard	: 740 mAh
Durée de vie de la batterie	: Environ 300 charges complètes (en fonction de l'utilisation)
Conditions de fonctionnement	
Température	: 0°C à 40°C (charge)/ -10°C à 60°C (fonctionnement)/ -20°C à 35°C (stockage)
Dimensions	: 31,5 × 39,5 × 6 mm
Poids	: Environ 15 g

Fr

● Chargeur de batterie (LI-40C)

Alimentation requise	: 100 à 240 V CA (50 à 60 Hz) 3,2 VA (100 V) à 5,0 VA (240 V)
Sortie	: 4,2 V CC, 200 mA
Durée de charge	: Environ 300 minutes
Conditions de fonctionnement	
Température	: 0°C à 40°C (fonctionnement)/ -20°C à 60°C (stockage)
Dimensions	: 62 × 23 × 90 mm
Poids	: Environ 65 g

La conception et les caractéristiques peuvent être modifiées sans préavis.

Précautions de sécurité



ATTENTION

RISQUE DE DÉCHARGE
ÉLECTRIQUE NE PAS OUVRIR



ATTENTION: POUR RÉDUIRE LE RISQUE DE DÉCHARGE ÉLECTRIQUE, NE RETIRER NI LA PARTIE ANTERIEURE NI POSTERIEURE DU BOÎTIER. AUCUNE PIÈCE À L'INTÉRIEUR NE PEUT ÊTRE RÉPARÉE PAR L'UTILISATEUR. SE RÉFÉRER À DU PERSONNEL DE DÉPANNAGE QUALIFIÉ POUR UNE RÉPARATION.



Le point d'exclamation à l'intérieur d'un triangle vous alerte sur certains points importants concernant le maniement et l'entretien de l'appareil figurant dans la documentation fournie avec le produit.



DANGER

Si le produit est utilisé sans respecter les informations données sous ce symbole, des blessures graves, voire mortelles pourraient en résulter.



AVERTISSEMENT

Si le produit est utilisé sans respecter les informations données sous ce symbole, des blessures voire la mort pourraient en résulter.



ATTENTION

Si le produit est utilisé sans observer les informations données sous ce symbole, des blessures, des dommages à l'appareil ou des pertes de données pourraient en résulter.

AVERTISSEMENT !

POUR ÉVITER LES RISQUES D'INCENDIE OU DE DÉCHARGE ÉLECTRIQUE, NE JAMAIS DÉMONTER, EXPOSER CE PRODUIT À L'EAU NI LE FAIRE FONCTIONNER DANS UN ENVIRONNEMENT TRÈS HUMIDE.

Précautions générales

Lire toutes les instructions — Avant d'utiliser l'appareil, lire toutes les instructions de fonctionnement. Sauvegarder tous les manuels et la documentation pour s'y référer ultérieurement.

Nettoyage — Toujours débrancher ce produit de la prise de courant avant nettoyage. N'utiliser qu'un chiffon humide pour le nettoyage. Ne jamais utiliser de produits de nettoyage liquides ou aérosols, ni de solvants organiques pour nettoyer ce produit.

Accessoires — Pour votre sécurité, et pour éviter d'endommager le produit, n'utiliser que des accessoires recommandés par Olympus.

Eau et humidité — Pour les précautions sur des produits avec une conception imperméable, lire les sections imperméabilisation.

Emplacement — Pour éviter d'endommager l'appareil, monter le produit solidement sur un trépied ou un sabot stable.

Alimentation — Ne raccorder ce produit qu'à la source d'alimentation décrite sur l'étiquette du produit.

Entrée d'objets — Pour éviter des blessures, ne jamais introduire d'objet métallique dans le produit.

Chaleur — Ne jamais utiliser ni ranger ce produit près d'une source de chaleur telle qu'un radiateur, un accumulateur de chaleur, ou tout type d'appareil qui génère de la chaleur, comprenant les amplificateurs.



AVERTISSEMENT

- **Ne pas utiliser l'appareil à proximité de gaz inflammables ou explosifs.**
- **Ne pas utiliser le flash de très près sur des personnes (bébés, jeunes enfants, etc.).**
 - Vous devez être au moins à 1 m des visages de vos sujets. Déclencher le flash trop près des yeux du sujet pourrait causer une perte momentanée de la vision.
 - Ne pas laisser l'appareil à la portée des enfants.
 - Toujours utiliser et ranger l'appareil hors de la portée des jeunes enfants et des bébés pour empêcher les situations dangereuses suivantes qui pourraient causer des blessures graves :
 - S'enrouler dans la courroie de l'appareil, causant la strangulation.
 - Avaler accidentellement la batterie, des cartes ou d'autres petites pièces.
 - Déclencher accidentellement le flash dans leurs yeux ou ceux d'un autre enfant.
 - Se blesser accidentellement par des parties en mouvement de l'appareil.
- **Ne pas regarder le soleil ni de la lumière puissante avec l'appareil.**
- **Ne pas utiliser ni ranger l'appareil dans des endroits poussiéreux ou humides.**
- **Ne pas couvrir le flash avec une main pendant le déclenchement.**



ATTENTION

- **Arrêter immédiatement d'utiliser l'appareil si vous remarquez une odeur, un bruit anormal ou de la fumée provenant de l'appareil.**
 - Ne jamais retirer les batteries les mains nues, ce qui pourrait vous brûler les mains.
- **Ne jamais manipuler l'appareil avec des mains mouillées.**
- **Ne pas laisser l'appareil dans des endroits où il pourrait être soumis à des températures très élevées.**
 - Ceci pourrait causer une détérioration de certaines pièces et, dans certaines circonstances, l'appareil pourrait prendre feu. Ne pas utiliser le chargeur s'il est couvert (par exemple par une couverture). Ce qui pourrait causer une surchauffe, débouchant sur un incendie.
- **Manipuler l'appareil soigneusement afin d'éviter une brûlure à basse température.**
 - Lorsque l'appareil contient des parties métalliques, une surchauffe peut déboucher sur une brûlure à basse température. Faire attention aux points suivants :
 - Utilisé pendant une longue durée, l'appareil devient chaud. Si vous tenez l'appareil dans ces conditions, une brûlure à basse température risque de se produire.
 - Dans des endroits sujets à des températures très froides, la température du corps de l'appareil peut être plus basse que la température ambiante. Si possible, mettre des gants en tenant l'appareil à des températures basses.
- **Faire attention avec la courroie.**
 - Faire attention avec la courroie en portant l'appareil. Elle peut facilement s'accrocher à des objets sur le passage et causer des dommages sérieux.

Précautions de manipulation de la batterie

Veillez suivre ces consignes importantes pour éviter le coulage du liquide de la batterie, une génération de chaleur, des brûlures, une explosion, ou de causer des décharges électriques ou brûlures.

DANGER

- L'appareil photo utilise une batterie lithium ion spécifiée par Olympus. Chargez l'appareil avec le chargeur spécifié. N'utilisez aucun autre chargeur.
- Ne jamais chauffer ni mettre au feu la batterie.
- Prendre des précautions en transportant ou rangeant la batterie pour éviter qu'elle vienne en contact avec des objets métalliques comme des bijoux, des épingles à cheveux, des agrafes, etc.
- Ne jamais ranger la batterie dans un lieu où elle serait exposée en plein soleil, ou sujette à des températures élevées dans un véhicule chaud, près d'une source de chaleur, etc.
- Pour éviter de causer des coulages de liquide de la batterie ou d'endommager ses bornes, respecter scrupuleusement toutes les instructions concernant l'usage de la batterie. Ne jamais tenter de démonter la batterie ni la modifier, en soudant, etc.
- Si du liquide de la batterie entrait dans vos yeux, les laver immédiatement avec de l'eau claire et froide du robinet et consulter immédiatement un médecin.
- Toujours ranger la batterie hors de la portée des jeunes enfants. Si un enfant avale accidentellement une batterie, consulter immédiatement un médecin.

AVERTISSEMENT

- Maintenir à tout moment la batterie au sec.
- Pour éviter un coulage du liquide de la batterie, une génération de chaleur ou de causer un incendie ou une explosion, n'utiliser que la batterie recommandée pour l'usage avec ce produit.
- Introduire soigneusement la batterie comme décrit dans les instructions de fonctionnement.
- Si les batteries rechargeables n'ont pas été rechargées au bout de la durée spécifiée, arrêter de les charger et ne pas les utiliser.
- Ne pas utiliser une batterie si elle est endommagée ou cassée.
- Si la batterie coule, devient décolorée ou déformée, ou devient anormale sous d'autres aspects pendant le fonctionnement, arrêter d'utiliser l'appareil.
- Si du liquide de la batterie coule sur vos vêtements ou sur votre peau, retirer le vêtement et laver immédiatement la zone affectée avec de l'eau claire et froide du robinet. Si le liquide vous brûle la peau, consulter immédiatement un médecin.
- Ne jamais soumettre la batterie à des chocs violents ni à des vibrations continues.

ATTENTION

- Avant sa mise en place, toujours contrôler soigneusement la batterie pour des coulages, décoloration, gauchissement ou toutes autres anomalies.
- La batterie peut devenir chaude pendant une utilisation prolongée. Pour éviter des brûlures mineures, ne pas la retirer immédiatement après avoir utilisé l'appareil.
- Toujours retirer la batterie de l'appareil avant de le ranger pour une longue durée.

Pour les utilisateurs d'Amérique du Nord et du Sud

Pour les utilisateurs aux États-Unis

Déclaration de conformité

Modèle numéro : FE-230/X-790
FE-240/X-795
Marque : OLYMPUS
Organisme responsable : OLYMPUS IMAGING AMERICA INC.
Adresse : 3500 Corporate Parkway, P.O. Box 610, Center Valley,
PA 18034-0610, U.S.A.
Numéro de téléphone : 484-896-5000

Testé pour être en conformité avec la réglementation FCC
POUR L'UTILISATION A LA MAISON OU AU BUREAU

Cet appareil est conforme aux normes de la Section 15 des directives FCC. Son utilisation est soumise aux deux conditions suivantes :

- (1) Cet appareil ne doit pas causer de brouillage radioélectrique.
- (2) Cet appareil doit pouvoir résister à toutes les interférences, y compris celles susceptibles d'entraver son bon fonctionnement.

Pour les utilisateurs au Canada

Cet appareil numérique de la catégorie B est conforme à la législation canadienne sur

Fr

Marques déposées

- IBM est une marque déposée de la société International Business Machines Corporation.
- Microsoft et Windows sont des marques déposées de la société Microsoft Corporation.
- Macintosh est une marque de Apple Computer Inc.
- xD-Picture Card™ est une marque déposée.
- Tous les autres noms de sociétés et appellations de produits sont des marques, déposées ou non, des propriétaires respectifs.
- Les normes pour les systèmes de fichiers d'appareil photo indiquées dans ce manuel sont les normes "Design Rule for Camera File System/DCF" stipulées par l'association JEITA (Japan Electronics and Information Technology Industries Association).

Tabla de contenidos

Contenido de la caja	51
Fije la correa.....	51
Prepare la batería	52
Encienda la cámara	53
Ajuste la fecha y hora	54
Información de la pantalla de ajuste de fecha y hora.....	54
Ajuste el idioma	56
Tome una fotografía	57
Revise sus fotografías	58
Borrado de imágenes.....	58
Funcionamiento básico	59
Botones del modo de fotografía.....	59
Modos de escena.....	60
Modo macro.....	60
Modos de flash.....	61
Disparador automático.....	61
Función de ahorro de energía.....	61
Menús y ajustes	62
Menú superior.....	62
Borrar todas las fotografías.....	62
Conexión de la cámara	63
Reproducción en un televisor.....	63
Impresión directa (PictBridge).....	64
Transferir imágenes	65
Software OLYMPUS Master	67
Especificaciones	68
Precauciones de seguridad	70

- Antes de utilizar la cámara, lea con atención este manual para asegurarse de su uso correcto.
- Antes de tomar fotografías importantes, le recomendamos que realice varias tomas de prueba para familiarizarse con el uso de su cámara.
- Le rogamos observe todas las precauciones de seguridad que figuran al final de este manual.
- Las imágenes que aparecen en la pantalla y las ilustraciones de la cámara utilizadas en este manual pueden ser distintas que el producto real. A menos que se indique lo contrario, las ilustraciones están basadas en el modelo FE-230/X-790.

Contenido de la caja



Cámara digital



Correa

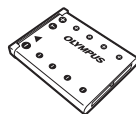

Batería de iones de litio
(LI-42B)

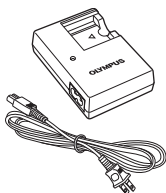

Cargador de
batería (LI-40C)

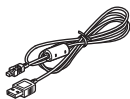

Cable USB

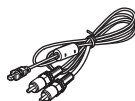

Cable AV



OLYMPUS Master
CD-ROM

Componentes no mostrados: Manual Avanzado (CD-ROM), Manual Básico (este manual) y tarjeta de garantía. Los contenidos pueden variar dependiendo del lugar de compra.

Fije la correa

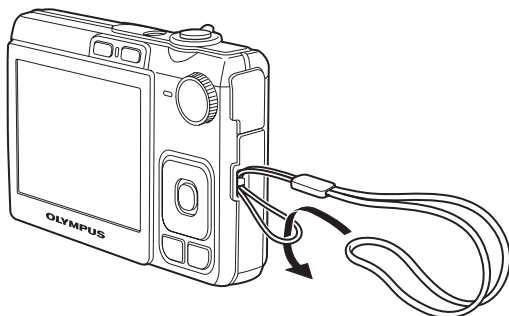

- Tire de la correa para que quede apretada y no se suelte.

Es

Prepare la batería

a. Cargue la batería.

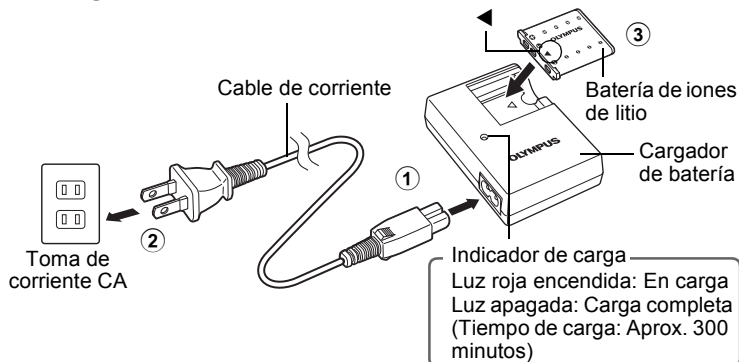

Es

- La batería viene cargada parcialmente.

b. Inserte la batería en la cámara.

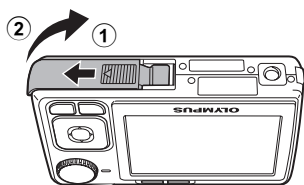

- Inserte la batería en la dirección indicada por la marca ▼.

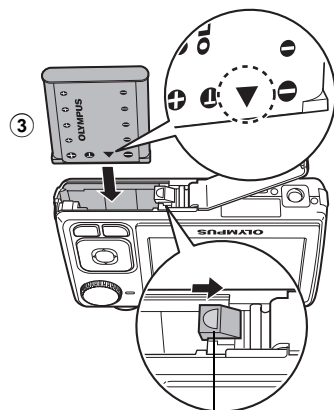
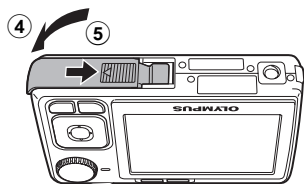

Botón de bloqueo de la batería

- Para extraer la batería, presione el botón de bloqueo de la batería en la dirección de la flecha.
- Esta cámara le permite tomar fotos sin tener que insertar la tarjeta opcional xD-Picture Card™ (en adelante, "la tarjeta"). Para obtener información acerca de la inserción de la tarjeta, consulte el Manual Avanzado.

Encienda la cámara

Esta sección explica cómo encender la cámara en el modo de fotografía.

a. Sitúe el disco de modo en **AUTO**.

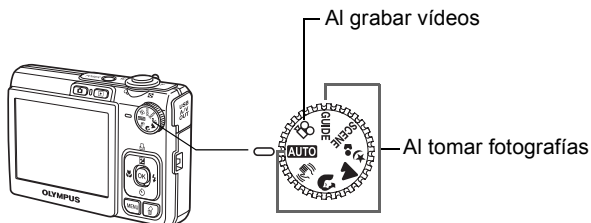

Modos de toma de fotografías

AUTO	Para toma de fotografías normal.
	Esta función reduce la posibilidad de que las fotografías salgan borrosas debido al movimiento del sujeto o de la cámara.
	Adecuado para tomar fotografías de personas.
	Adecuado para tomar fotografías de paisajes.
	Adecuado para tomar fotografías de personas por la noche.
SCENE	Seleccione uno de los 10 modos de escena (FE-240/X-795) o 13 modos de escena disponibles (FE-230/X-790) en función de las condiciones fotográficas.
GUIDE	Utilice la toma de imágenes que se muestra en la pantalla para fotografiar según la situación.

Es

b. Presione el botón **POWER**.

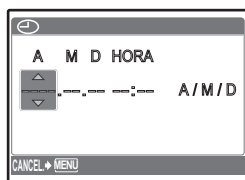
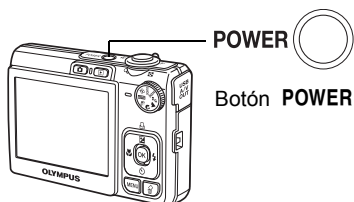

● Esta pantalla aparece si la fecha y la hora no están ajustadas.

● Para apagar la cámara, presione de nuevo el botón **POWER**.

Consejo

En el manual de instrucciones suministrado se indica la dirección de las teclas de control con Δ ∇ \triangleleft \triangleright .

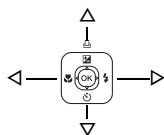

Ajuste la fecha y hora

Información de la pantalla de ajuste de fecha y hora

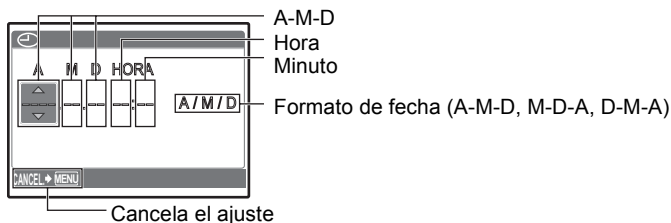

a. Presione los botones Δ y ∇ para seleccionar [A].

- Los dos primeros dígitos del año son fijos.

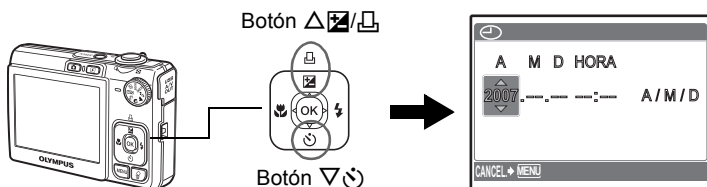



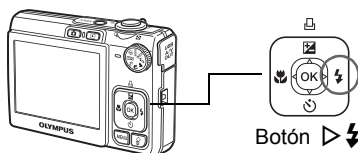

b. Presione el botón \triangleright .







c. Presione los botones Δ y ∇ para seleccionar [M].







- d. Presione el botón .
- e. Presione los botones ,  y  para seleccionar [D].





- f. Presione el botón .
- g. Presione los botones ,  y  para seleccionar las horas y los minutos.
- La hora se muestra en el formato de 24 horas.



- h. Presione el botón .
- i. Presione los botones ,  y  para seleccionar [A/M/D].



- j. Cuando se hayan realizado todos los ajustes, presione .
- Para un ajuste más preciso, presione  cuando el reloj marque 00 segundos.

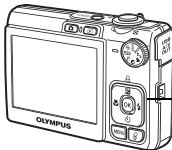

Es

Ajuste el idioma

a. Presione el botón **MENU** para ver el menú superior.

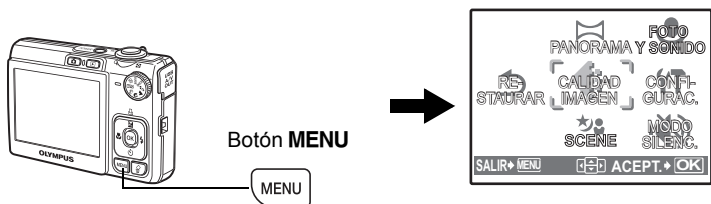

b. Presione el botón **▷⚡** para seleccionar **[CONFIGURAC.]** y presione **OK**.

Es

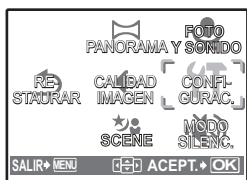

c. Presione los botones **△+⊕/□** y **▽⌚** para seleccionar **[⚙️]**, y presione **OK**.

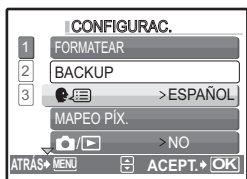

d. Presione las teclas de control (**△▽◀▶**) para elegir un idioma y, a continuación, presione **OK**.

- Se pueden añadir otros idiomas a la cámara con el software OLYMPUS Master suministrado. Consulte el Manual Avanzado.

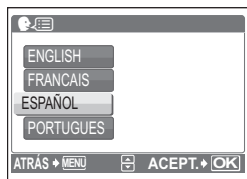

Tome una fotografía

a. Sujete la cámara.

Sujeción horizontal

Sujeción vertical

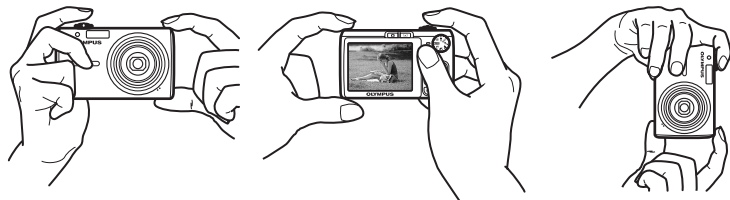

b. Enfoque.

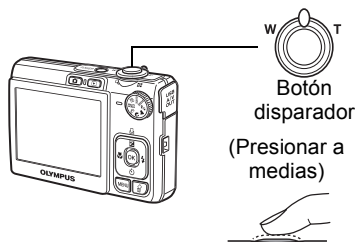

Coloque esta marca sobre su sujeto.



Se muestra el número de fotografías que se pueden tomar.

El piloto verde indica que el enfoque y la exposición están bloqueados.

Es

c. Tome la fotografía.

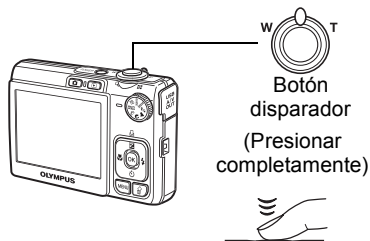

El piloto de control de la tarjeta parpadea.



Revise sus fotografías

a. Presione el botón .

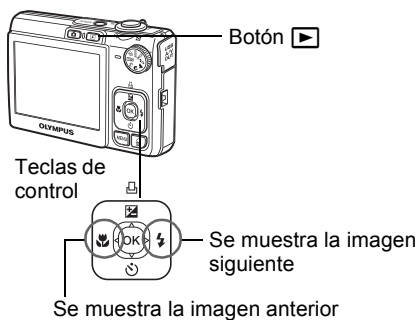





Es

Borrado de imágenes

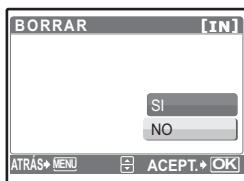
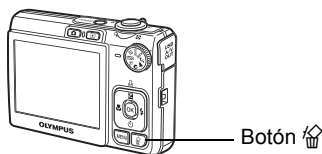
a. Presione los botones  y  para ver la fotografía que desea borrar.

b. Presione el botón .



c. Presione el botón /, seleccione [SI] y presione .

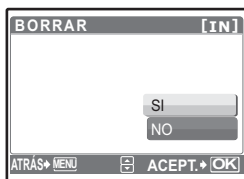
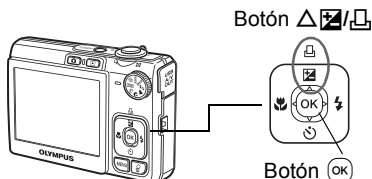







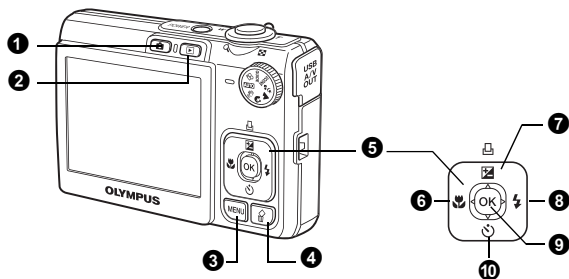







Funcionamiento básico

Botones del modo de fotografía

En el modo de fotografía, puede usar estos botones para acceder rápidamente a las funciones más habituales.



- 1 Botón  (Fotografía)**
Selecciona el modo de fotografía.
- 2 Botón  (Reproducción)**
Selecciona el modo de reproducción.
- 3 Botón MENU**
Muestra el menú superior.
- 4 Botón  (Borrar)**
Selecciona la imagen que desea borrar en el modo de reproducción.
- 5 Teclas de control (   **)
Selecciona las escenas, reproduce imágenes y elementos de menú.
- 6 Botón  (Modo macro)**
Activa el modo macro o supermacro para obtener primeros planos.
- 7 Botón  (Compensación de la exposición/Imprimir)**
En modo de fotografía, presione este botón para ajustar el valor de compensación de la exposición, que influye en la luminosidad de la imagen.
- 8 Botón  (Modo de flash)**
Es posible seleccionar de entre 4 modos de flash - AUTO,  (Reducción del efecto de ojos rojos),  (Flash de relleno) o  (Flash desactivado).
- 9 Botón  (OK)**
Confirma los ajustes.
- 10 Botón  (Disparador automático)**
Seleccione el disparador automático para retrasar la toma 12 segundos aproximadamente desde el momento de presionar el botón disparador.

Modos de escena

Esta función le permite cambiar el modo de **SCENE** (escena) en función del sujeto.

- 1 Sitúe el disco de modo en **SCENE**.

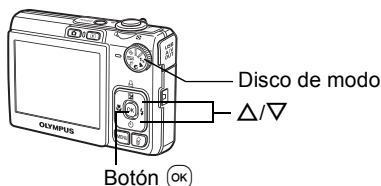

- 2 Presione Δ/∇ para seleccionar los modos de escena y presione OK .

Fotografía de modos de escena

- DEPORTE
- INTERIORES
- VELAS
- AUTO - RETRATO
- PUESTA SOL
- FUEG.ARTIF.
- VITRINA
- COCINA
- DOCUMENTOS
- SUBASTA
- SUBACUÁTICO AMPLIO.1^{*1}
- SUBACUÁTICO AMPLIO.2^{*1}
- SUBACUÁTICO MACRO^{*1}





*1 Disponible únicamente para el modelo FE-230/X-790.



Modo macro

- Este modo le permite tomar fotos del sujeto a tan solo 10 cm de distancia con el modelo FE-230/X-790, y a 20 cm de distancia con el modelo FE-240/X-795. (en el ángulo mayor)
- Utilice este modo para tomar fotos del sujeto a tan solo 5 cm de distancia con el modelo FE-230/X-790, y a 3 cm de distancia con el modelo FE-240/X-795. En el modo , la posición del objetivo zoom está fijada.

- 1 Presione varias veces el botón \triangleleft para seleccionar o y presione OK .





Modos de flash

- 1 Presione varias veces el botón   para seleccionar el modo de flash y presione .
- 2 Presione a medias el botón disparador.
 - Si el flash está ajustado para dispararse, se ilumina la marca .
- 3 Presione el botón disparador a fondo para tomar la fotografía.

Icono	Modo de flash	Descripción
Sin indicación	Flash automático	El flash se dispara automáticamente en condiciones de baja iluminación o de contraluz.
	Flash con reducción de ojos rojos	El modo de flash con reducción de ojos rojos reduce significativamente este fenómeno emitiendo destellos previos antes de dispararse el flash normal.
	Flash de relleno	El flash se dispara independientemente de la luz disponible.
	Flash desactivado	El flash no se dispara, incluso en condiciones de baja iluminación.

Es

Disparador automático

- 1 Presione el botón   para seleccionar [] y presione .
- 2 Presione el botón disparador a fondo para tomar la fotografía.
 - El LED del disparador automático se ilumina durante unos 10 segundos después de presionar el botón disparador, luego empieza a parpadear. Tras parpadear durante 2 segundos aproximadamente, se toma la fotografía.

LED del disparador automático



Función de ahorro de energía

- Para ahorrar energía de la batería, la cámara entra automáticamente en el modo de reposo y deja de funcionar después de unos 3 minutos de inactividad en modo de fotografía. Utilice el botón disparador o el mando de zoom para reactivar la cámara.
- Si la cámara no se utiliza durante aproximadamente 12 minutos después de entrar en el modo de reposo, se retrae automáticamente el objetivo y se apaga. Para volver a utilizarla, enciéndala otra vez.

Menús y ajustes

Menú superior

- 1 Presione el botón **MENU** para ver el menú superior en el monitor.
- 2 Use las teclas de control (Δ ∇ \langle \rangle) para seleccionar los elementos de menú.

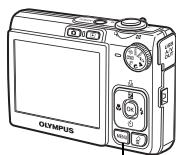

Botón **MENU**

MENU

Menú superior en modo de fotografía



Es

CALIDAD IMAGEN

Ajusta la calidad de imagen y la resolución.

PANORAMA

Crea una fotografía panorámica.

RESTAURAR

Permite restaurar los ajustes predefinidos de fábrica.

SCENE

Seleccione una escena en función del sujeto y las condiciones fotográficas.

MODO SILENC.

Desactiva los sonidos de las funciones, los sonidos de advertencia, el sonido del disparador, etc. durante la toma de fotografías y la reproducción.

CONFIGURAC.

Ajusta la fecha y hora, el idioma y otros ajustes.

FOTO Y SONIDO/VIDEO Y SONIDO

Graba el sonido durante la filmación.

Borrar todas las fotografías

- 1 Presione el botón **MENU** para ver el menú superior en modo de reproducción.
- 2 Seleccione **[BORRAR]**, **[BORRAR TODO]** y presione **(OK)**.
- 3 Seleccione **[SI]** y presione **(OK)**.
 - Se borran todas las fotografías.

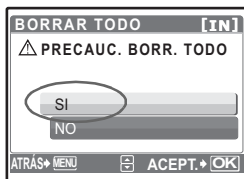

Conexión de la cámara



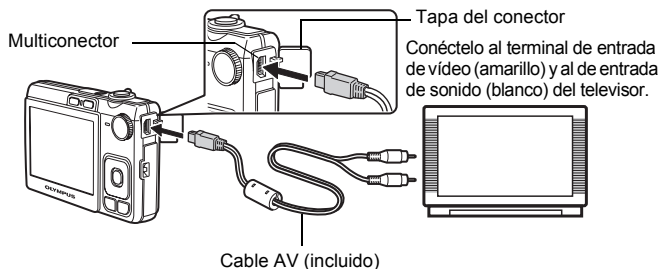

Reproducción en un televisor

Utilice el cable AV suministrado con la cámara para reproducir imágenes grabadas en un televisor. Puede reproducir tanto fotografías como vídeos.

- 1 Compruebe que el televisor y la cámara estén apagados. Conecte el multiconector de la cámara al terminal de entrada de vídeo del televisor usando el cable AV.



Es

- 2 Encienda el televisor y cambie al modo de entrada de vídeo.
 - Para más información sobre cómo cambiar a entrada de vídeo, consulte el manual de instrucciones del televisor.
- 3 Encienda la cámara y presione el botón  para seleccionar el modo de reproducción.
 - En el televisor aparecerá la última fotografía tomada. Utilice las teclas de control (   ) para seleccionar la fotografía que desea ver.

Impresión directa (PictBridge)

Usando el cable USB suministrado, puede conectar la cámara a una impresora compatible con PictBridge para imprimir fotografías. Puede imprimir una imagen realizando unas sencillas operaciones.

- 1 En el modo de reproducción, localice en el monitor la fotografía que desea imprimir.
- 2 Conecte un extremo del cable USB suministrado al multiconector de la cámara y el otro extremo al conector USB de la impresora.

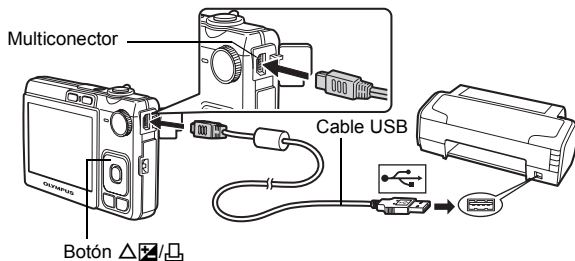

- 3 Presione el botón Δ/X/OK.
 - Se inicia la impresión.
 - Cuando haya terminado, desconecte el cable USB de la cámara con la pantalla de selección de fotografías activa.



Transferir imágenes

a. Instale el software

- 1 Inserte el CD-ROM de OLYMPUS Master.
- 2 **Windows:** Haga clic en el botón "OLYMPUS Master 2".
Macintosh: Haga doble clic en el icono "Setup".
- 3 Siga las instrucciones en pantalla.

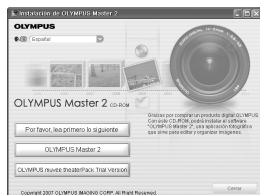

b. Conecte la cámara a un ordenador

- 1 Conecte la cámara y el ordenador usando el cable USB (incluido).
 - El monitor se encenderá automáticamente.

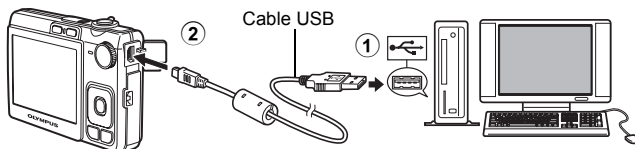

- 2 Seleccione [PC] en el monitor y presione (OK).

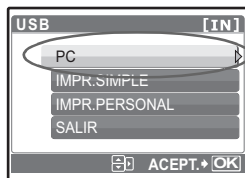



- Ahora el ordenador reconocerá su cámara como una unidad de almacenamiento extraíble.

Es

c. Transfiera las imágenes al ordenador

1 Ahora, con la cámara conectada, abra el programa OLYMPUS Master.

2 Haga clic en “Transferir imágenes”  en la ventana de examinar y haga clic en “De cámara”  .



3 Siga las instrucciones en pantalla.

Es

Consejos

- Para obtener información más detallada sobre la configuración y el uso de la cámara, consulte el “Manual Avanzado” de la misma incluido en el CD-ROM.
- Si necesita ayuda adicional, consulte el archivo “Ayuda” del software OLYMPUS Master.

Software OLYMPUS Master

Software OLYMPUS Master: Utilice este software para descargar fotografías de la cámara, ver, organizar, retocar, enviar por correo electrónico e imprimir sus fotografías y vídeos digitales, y mucho más.



● Requisitos del sistema

SO	Windows 2000 Professional/XP Home Edition/XP Professional/Vista o Mac OS X (10.3 o posterior)
CPU	Pentium III 500 MHz/Power PC G3 500 MHz/Intel Core Solo/Duo 1.5 GHz, o posterior
RAM	256 MB o más
Disco duro	500 MB de espacio libre o más
Conexión	Puerto USB/puerto IEEE 1394
Monitor	1024 × 768 píxeles de resolución o más con un mínimo de 65.536 colores (Windows), 32.000 colores (Macintosh)
Otros	Internet Explorer 6 o posterior (Windows), Safari 1.0 o posterior, QuickTime 6 o posterior (Macintosh)

Es

Para obtener la información técnica más reciente, visite la página web de Olympus (<http://www.olympus.com/>)



Registro de usuario

Registre su cámara cuando instale OLYMPUS Master para activar su garantía, recibir notificaciones sobre actualizaciones de software y firmware de la cámara, y mucho más.

Especificaciones

● Cámara

Tipo de producto	: Cámara digital (para fotografía y reproducción)
Sistema de grabación	
Fotografías	: Grabación digital, JPEG (según la norma Design rule for Camera File system (DCF))
Estándares aplicables	: Exif 2.2, Formato de reserva de impresión digital (DPOF), PRINT Image Matching III, PictBridge
Sonido con fotografías	: Formato WAVE
Vídeo	: AVI Motion JPEG
Memoria	: Memoria interna xD-Picture Card (16 MB – 2 GB) (Type H/M, Standard)
Número de píxeles efectivos	: 7.100.000 píxeles
Dispositivo de captura de imagen	: CCD de 1/2,5" (filtro de colores primarios), 7.400.000 píxeles (brutos)
Objetivo	: FE-230/X-790: Objetivo Olympus 6,3 a 18,9 mm, f3,1 a 5,9 (equivalente a un objetivo de 38 a 114 mm en una cámara de 35 mm) FE-240/X-795: Objetivo Olympus 6,4 a 32 mm, f3,3 a 5,0 (equivalente a un objetivo de 38 a 190 mm en una cámara de 35 mm)
Sistema fotométrico	: Medición ESP digital
Velocidad de obturación	: 4 a 1/2000 seg.
Alcance de fotografía	: FE-230/X-790: 0,6 m a ∞ (W), 1,0 m a ∞ (T) (modo normal) 0,1 m a ∞ (W), 0,6 m a ∞ (T) (modo macro) 0,05 m (modo supermacro) FE-240/X-795: 0,7 m a ∞ (modo normal) 0,2 m a ∞ (W), 0,6 m a ∞ (T) (modo macro) 0,03 m (modo supermacro)
Monitor	: Pantalla LCD TFT en color de 2,5", 115.000 píxeles
Conector exterior	: conector USB, jack A/V OUT (multiconector)
Sistema de calendario automático	: 2000 hasta 2099
Entorno de funcionamiento	
Temperatura	: 0 °C a 40 °C (funcionamiento)/ -20 °C a 60 °C (almacenamiento)
Humedad	: 30% a 90% (funcionamiento)/ 10% a 90% (almacenamiento)
Fuente de alimentación	: Una batería de iones de litio Olympus (LI-42B/LI-40B)

Dimensiones	: FE-230/X-790: 90,5 mm (ancho) × 55,0 mm (altura) × 16,5 mm (prof.) (sin incluir los salientes) FE-240/X-795: 93,5 mm (ancho) × 56,0 mm (altura) × 20,0 mm (prof.) (sin incluir los salientes)
Peso	: FE-230/X-790: 105 g sin la batería ni la tarjeta FE-240/X-795: 115 g sin la batería ni la tarjeta

● **Batería de iones de litio (LI-42B)**

Tipo de producto	: Batería recargable de iones de litio
Voltaje estándar	: CC 3,7 V
Capacidad estándar	: 740 mAh
Duración de la batería	: Aprox. 300 recargas completas (varía según el uso)
Entorno de funcionamiento	
Temperatura	: 0 °C a 40 °C (durante la carga)/ -10 °C a 60 °C (funcionamiento)/ -20 °C a 35 °C (almacenamiento)
Dimensiones	: 31,5 × 39,5 × 6 mm
Peso	: Aprox. 15 g

Es

● **Cargador de batería (LI-40C)**

Requisitos de potencia	: CA de 100 a 240 V (50 a 60 Hz) 3,2 VA (100 V) a 5,0 VA (240 V)
Salida	: CC 4,2 V, 200 mA
Tiempo de carga	: Aprox. 300 min.
Entorno de funcionamiento	
Temperatura	: 0 °C a 40 °C (funcionamiento)/ -20 °C a 60 °C (almacenamiento)
Dimensiones	: 62 × 23 × 90 mm
Peso	: Aprox. 65 g

El diseño y las especificaciones están sujetos a cambios sin previo aviso.

Precauciones de seguridad



PRECAUCIÓN
RIESGO DE DESCARGAS
ELÉCTRICAS
NO ABRIR



PRECAUCIÓN: PARA REDUCIR EL RIESGO DE DESCARGAS ELÉCTRICAS, NO RETIRE LA CUBIERTA (O PARTE TRASERA), EN EL INTERIOR NO HAY PIEZAS QUE EL USUARIO PUEDA REPARAR. REMITA LA REPARACIÓN A PERSONAL DE SERVICIO ESPECIALIZADO OLYMPUS.



El signo de admiración dentro de un triángulo equilátero tiene como finalidad alertar al usuario de la existencia de importantes instrucciones de operación y mantenimiento en la documentación suministrada con el producto.



PELIGRO

Si el producto es utilizado sin observar la información representada bajo este símbolo, podría causar serias lesiones o muerte.



ADVERTENCIA

Si el producto es utilizado sin observar la información representada bajo este símbolo, podría causar serias lesiones o muerte.



PRECAUCIÓN

Si el producto es utilizado sin observar la información representada bajo este símbolo, podría causar lesiones personales menores, daños al equipo, o pérdida de datos importantes.

¡ADVERTENCIA!
PARA EVITAR EL RIESGO DE INCENDIO O DESCARGAS ELÉCTRICAS, NUNCA DESMONTE NI EXPONGA ESTE PRODUCTO AL AGUA NI LO UTILICE EN UN ENTORNO MUY HÚMEDO.

Es

Precauciones Generales

- Lea todas las instrucciones** — Antes de utilizar este producto, lea todas las instrucciones operativas. Guarde todos los manuales y la documentación para futuras consultas.
- Limpieza** — Siempre desenchufe el producto de la toma de corriente antes de limpiarlo. Para la limpieza use sólo un paño húmedo. Nunca use limpiadores líquidos o aerosoles, ni solventes orgánicos de ningún tipo para limpiar este producto.
- Accesorios** — Para su seguridad y evitar daños al producto, utilice únicamente los accesorios recomendados por Olympus.
- Agua y humedad** — En las precauciones de los productos diseñados a prueba de la intemperie, consulte las secciones de resistencia a la intemperie en sus respectivos manuales.
- Ubicación** — Para evitarle daños al producto, monte el producto sobre un trípode, caballete o soporte estable.
- Fuentes de alimentación** — Conecte este producto únicamente con la fuente de alimentación descrita en la etiqueta del producto.
- Objetos extraños** — Para evitar daños personales, nunca inserte objetos de metal en el producto.
- Calentadores** — Nunca utilice ni guarde este producto cerca de fuentes de calor, tales como radiadores, rejillas de calefacción, estufas o cualquier tipo de equipo o aparato generador de calor, incluyendo amplificadores estéreo.



ADVERTENCIA

- **No utilice la cámara cerca de gases inflamables o explosivos.**
- **No utilice el flash a corta distancia de las personas (especialmente niños menores y mayores, etc.).**
 - Cuando dispare el flash, deberá mantener, por lo menos, una distancia de 1 m de la cara de los sujetos. El disparo demasiado cercano de los ojos del sujeto podrá causar la pérdida de visión momentánea.
 - Mantenga a los niños menores y mayores alejados de la cámara.
 - Utilice y guarde siempre la cámara fuera del alcance de los niños menores y mayores, para prevenir las siguientes situaciones de peligro que podrían causarles serias lesiones:
 - Enredarse con la correa de la cámara, ocasionando asfixia.
 - Ingerir accidentalmente una batería, tarjetas, u otras piezas pequeñas.
 - Disparar el flash accidentalmente hacia sus propios ojos o hacia los ojos de otro niño.
 - Lesionarse accidentalmente con las piezas móviles de la cámara.
- **No mire al sol ni a luces fuertes a través de la cámara.**
- **No utilice ni guarde la cámara en lugares polvorientos o húmedos.**
- **No cubra el flash con la mano mientras efectúa el disparo.**



PRECAUCIÓN

- **Interrumpa inmediatamente el uso de la cámara si percibe algún olor, ruido o humo extraño alrededor de la misma.**
 - Nunca retire las baterías con las manos descubiertas, ya que podría causar un incendio o quemarle las manos.
- **Nunca sujete ni utilice la cámara con las manos mojadas.**
- **No deje la cámara en lugares donde pueda estar sujeta a temperaturas extremadamente altas.**
 - Si lo hace puede provocar el deterioro de las piezas y, en algunas circunstancias, provocar que se prenda fuego. No utilice el cargador si está cubierto (por ejemplo con una manta). Esto podría causar recalentamiento, resultando en incendio.
- **Manipule la cámara con cuidado para evitar una quemadura leve.**
 - Ya que la cámara contiene partes metálicas, el recalentamiento puede resultar en una quemadura de baja temperatura. Preste atención a lo siguiente:
 - Cuando utilice la cámara durante un largo período, ésta se recalentará. Si mantiene la cámara en este estado, podría causar una quemadura de baja temperatura.
 - En lugares sujetos a temperaturas extremadamente bajas, la temperatura de la carcasa de la cámara puede ser más baja que la temperatura ambiente. Si es posible, póngase guantes cuando manipule la cámara en temperaturas bajas.
- **Tenga cuidado con la correa.**
 - Tenga cuidado con la correa cuando transporte la cámara. Podría engancharse en objetos sueltos y provocar daños graves.

Precauciones acerca del uso de la batería

Siga estas importantes indicaciones para evitar que se produzcan fugas, recalentamientos, incendios o explosión de la batería, o que cause descargas eléctricas o quemaduras.



PELIGRO

- La cámara utiliza una batería de iones de litio especificada por Olympus. Cargue la batería con el cargador especificado. No utilice otros cargadores.
- Nunca caliente ni incinere las baterías.
- Tome precauciones al transportar o guardar las baterías a fin de evitar que entren en contacto con objetos metálicos, tales como alfileres, horquillas, cierres, etc.
- Nunca guarde las baterías en lugares donde queden expuestas a la luz solar directa o sujetas a altas temperaturas en el interior de un vehículo con calefacción, cerca de fuentes de calor, etc.
- Para evitar que ocurran fugas de líquido de las baterías o daños de sus terminales, siga cuidadosamente todas las instrucciones respectivas al uso de las baterías. Nunca intente desarmar una batería ni modificarla de ninguna manera, por soldadura, etc.
- Si el fluido de la batería penetrara en sus ojos, lávelos de inmediato con agua corriente fresca y limpia, y solicite atención médica inmediatamente.
- Siempre guarde las baterías fuera del alcance de los niños menores. Si un niño ingiere una batería accidentalmente, solicite atención médica inmediatamente.



ADVERTENCIA

- Conserve la batería siempre seca.
- Para evitar que ocurran fugas de líquido, recalentamiento de la batería, o que cause incendio o explosión, utilice únicamente la batería recomendada para el uso con este producto.
- Inserte la batería cuidadosamente, tal como se describe en el manual de instrucciones.
- Si las baterías recargables no han sido recargadas dentro del tiempo especificado, interrumpa la carga y no las utilice.
- No utilice una batería si está rajada o quebrada.
- Si se producen fugas de líquido, decoloración o deformación de la batería, o cualquier otra anomalía durante la operación, interrumpa el uso de la cámara y consulte a su distribuidor o a un centro de servicio autorizado Olympus. El uso continuo de la cámara puede resultar en incendio o choques eléctricos.
- Si se producen fugas de líquido, decoloración o deformación de la batería, o cualquier otra anomalía durante la operación, interrumpa el uso de la cámara.
- Nunca exponga la batería a fuertes impactos ni a vibraciones continuas.



PRECAUCIÓN

- Antes de colocarla, siempre inspeccione la batería atentamente para verificar si no ocurre fugas de líquido, decoloración, deformación o cualquier otra anomalía.
- La batería puede recalentarse durante el uso prolongado. Para evitar quemaduras menores, no la retire inmediatamente después de utilizar la cámara.
- Siempre retire la batería de la cámara antes de guardar la cámara por un largo tiempo.

Para los clientes de Norte y Sudamérica

Para los clientes de Estados Unidos

Declaración de conformidad

Número de modelo : FE-230/X-790

FE-240/X-795

Nombre comercial : OLYMPUS

Entidad responsable: OLYMPUS IMAGING AMERICA INC.

Dirección : 3500 Corporate Parkway, P.O. Box 610, Center Valley,
PA 18034-0610, U.S.A.

Número de teléfono : 484-896-5000

Se ha probado su cumplimiento con las normas FCC

PARA USO DOMÉSTICO O COMERCIAL

Este dispositivo cumple con el Apartado 15 de las normas FCC. La operación se encuentra sujeta a las dos condiciones siguientes:

(1) Este dispositivo podría no causar interferencia perjudicial.

(2) Este dispositivo debe aceptar cualquier interferencia que se reciba, incluyendo aquellas interferencias que pueden provocar un funcionamiento no deseado.

Para los clientes de Canadá

Este aparato digital de Clase B cumple con todos los requerimientos de las

Es

Marcas comerciales

- IBM es una marca registrada de International Business Machines Corporation.
- Microsoft y Windows son marcas registradas de Microsoft Corporation.
- Macintosh es una marca comercial de Apple Computer Inc.
- xD-Picture Card™ es una marca comercial.
- Todos los demás nombres de compañías y productos son marcas registradas y/o marcas comerciales de sus respectivos propietarios.
- Las normas para sistemas de archivos de cámara referidas en este manual son las "Normas de Diseño para Sistema de Archivos de Cámara/DCF" estipuladas por la Asociación de Industrias Electrónicas y de Tecnología de Información de Japón (JEITA).

Índice

Reunir estes itens (conteúdo da embalagem)	75
Colocar a correia	75
Preparar a bateria	76
Ligar a câmara	77
Definir a data e hora	78
Sobre o ecrã de definição da data e hora	78
Definir o idioma	80
Fotografar	81
Ver as suas imagens	82
Apagar imagens	82
Funcionamento básico	83
Botões Modo Fotografia	83
Modos Cena	84
Modo Macro	84
Modos de Flash	85
Temporizador	85
Função Economia Energia	85
Menus e definições	86
Menu principal	86
Apagar todas as imagens.....	86
Ligar a câmara	87
Reproduzir numa TV	87
Impressão directa (PictBridge)	88
Transferir imagens	89
Software OLYMPUS Master	91
Especificações	92
Precauções de segurança	94

- Antes de usar a sua câmara, leia atentamente o presente manual de modo a garantir a sua correcta utilização.
- É aconselhável testar as fotografias de modo a familiarizar-se com a sua câmara antes de fotografar imagens importantes.
- Cumpra rigorosamente as precauções de segurança indicadas no final do manual.
- As imagens no ecrã LCD e as ilustrações da câmara usadas neste manual podem variar ligeiramente deste equipamento. Salvo indicação em contrário, a explicação sobre estas ilustrações é fornecida no modelo FE-230/X-790.

Reunir estes itens (conteúdo da embalagem)



Câmara Digital



Correia

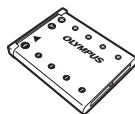

Bateria de íões de lítio
(LI-42B)

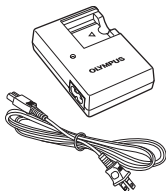

Carregador de
bateria (LI-40C)

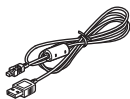

Cabo USB

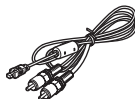

Cabo AV



CD-ROM
OLYMPUS Master

Itens não visualizados: Manual Avançado (CD-ROM), Manual Básico (o presente manual) e o Certificado de Garantia. O conteúdo pode variar mediante o local de aquisição.

Colocar a correia

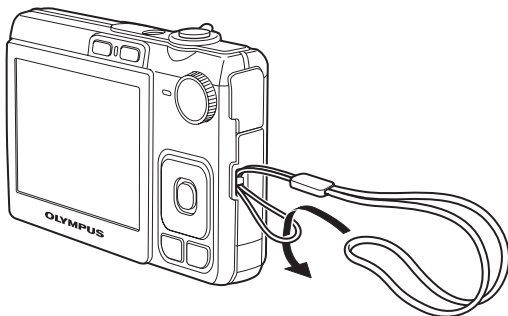

- Puxar bem a correia de modo a que não fique solta.

Preparar a bateria

a. Carregar a bateria.

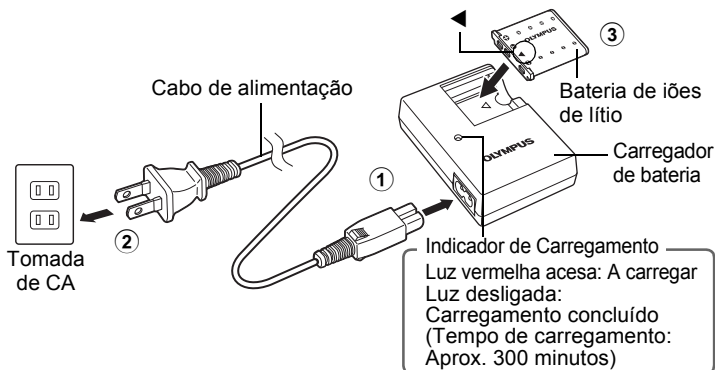

- A bateria vem parcialmente carregada.

b. Introduzir a bateria na câmara.

Pt

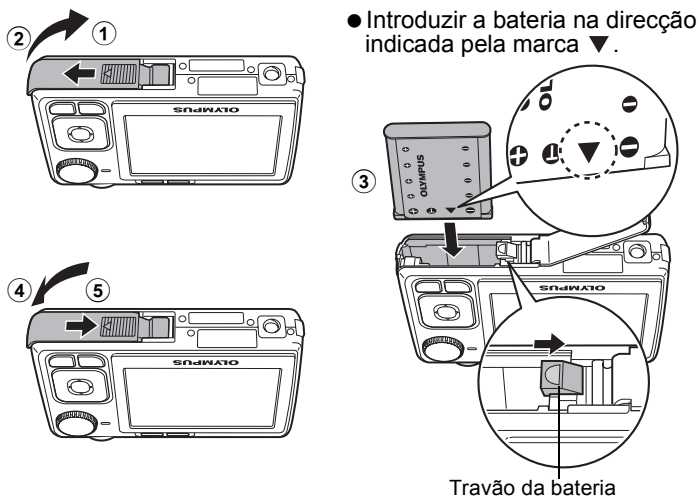

- Introduzir a bateria na direcção indicada pela marca ▼.

- Para remover a bateria, prima o travão da bateria na direcção indicada pela seta.

- Com esta câmara, pode-se tirar fotografias sem introduzir o xD-Picture Card™ opcional (a partir de aqui designado apenas por “cartão”). De modo a obter informações sobre como introduzir o cartão, consultar o Manual avançado.

Ligar a câmara

Este modo explica como ligar a câmara no modo fotografia.

a. Colocar o selector de modo em **AUTO**.

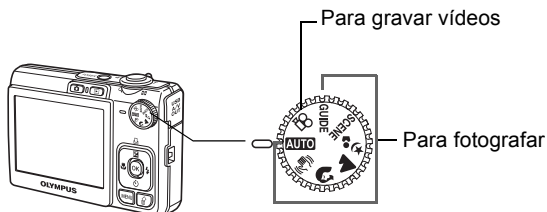

Modos de fotografia

AUTO	Para uma fotografia normal.
	Esta função reduz o efeito de arrastamento resultante de um tema fotográfico em movimento ou da própria oscilação da câmara ao fotografar.
	Ideal para fotografar pessoas.
	Ideal para fotografar uma paisagem.
	Ideal para fotografar pessoas à noite.
SCENE	Selecione de entre os 10 (FE-240/X-795) ou 13 (FE-230/X-790) modos de cena disponíveis, de acordo com as condições fotográficas.
GUIDE	Usar o assistente de fotografia, visualizado no ecrã, para fotografar imagens mediante a situação.

b. Premir o botão **POWER**.

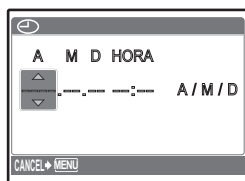
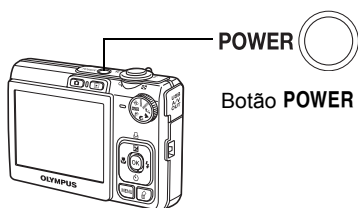

- No caso da data e da hora não estarem definidas, é visualizado o ecrã seguinte.

- Para desligar a câmara, premir novamente o botão **POWER**.

Sugestão

As direcções do selector em cruz são indicadas com no manual de instruções fornecido.

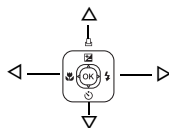

Definir a data e hora

Sobre o ecrã de definição da data e hora

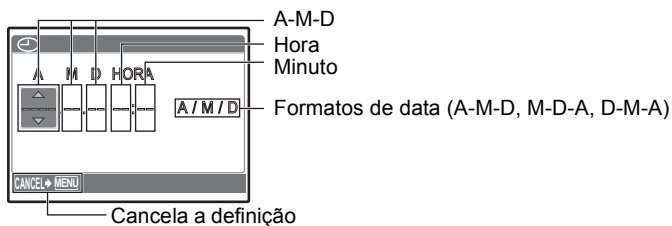

a. Premir os botões e de modo a seleccionar [A].

- Os primeiros dois dígitos do ano são fixos.

Pt

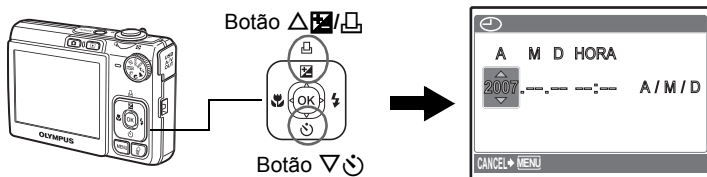



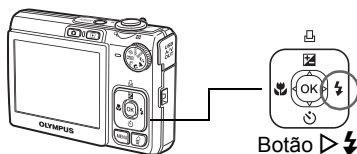

b. Premir o botão .

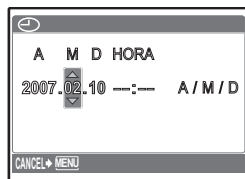





c. Premir os botões e para seleccionar [M].







- d. Premir o botão .
- e. Premir os botões /  e  para seleccionar [D].



- f. Premir o botão .
- g. Premir os botões /  e  para seleccionar as horas e minutos.
- A hora é visualizada no formato de 24 horas.



- h. Premir o botão .
- i. Premir os botões /  e  para seleccionar [A/M/D].



- j. Depois de configuradas todas as definições, premir .

- Para uma definição mais precisa, premir  quando o sinal de hora chegar aos 00 segundos.

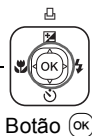
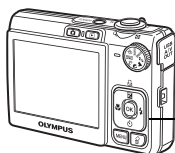

Definir o idioma

- a. Premir o botão MENU para visualizar o menu superior.



Botão MENU

MENU

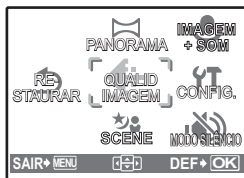

- b. Premir o botão para seleccionar [CONFIG.] e premir .

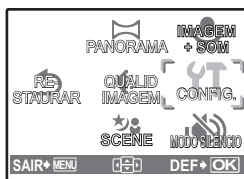

- c. Premir os botões e para seleccionar e premir .

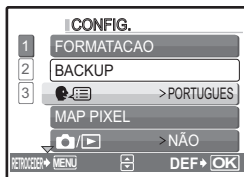

- d. Pressione o selector em cruz () para seleccionar um idioma e pressione .

- Pode adicionar outros idiomas à sua câmara usando o software OLYMPUS Master fornecido. Consultar o Manual Avançado.

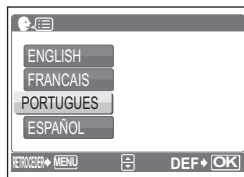

Fotografar

a. Segurar a câmara.

Segurar na horizontal

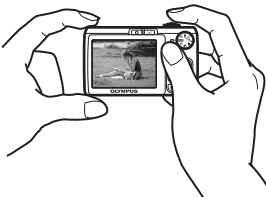
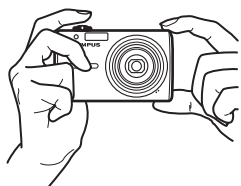

Segurar na vertical

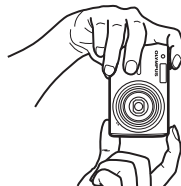

b. Focagem.

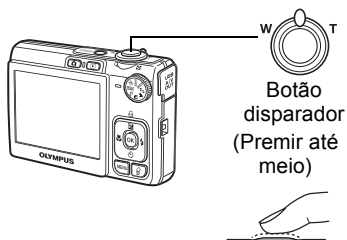

Botão disparador
(Premir até meio)

Centrar esta marca sobre o seu tema fotográfico.



É visualizado o número de imagens disponíveis para fotografar.

A luz verde indica que a focagem e a exposição estão bloqueadas.

Pt

c. Fotografar.

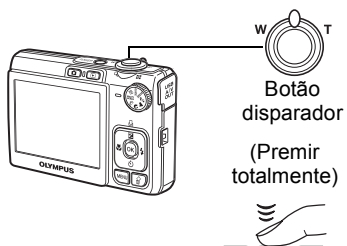

Botão disparador
(Premir totalmente)

A luz de acesso ao cartão fica intermitente.



Ver as suas imagens

a. Premir o botão .

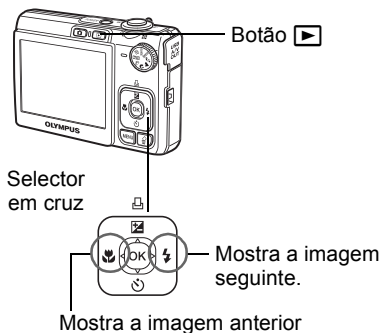

Apagar imagens

Pt

a. Premir os botões e de modo a visualizar a imagem que pretende apagar.

b. Premir o botão .

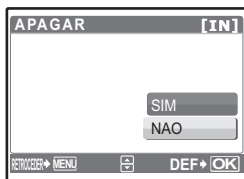
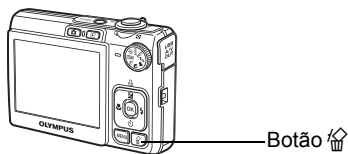

c. Premir o botão / , para seleccionar [SIM], e premir .

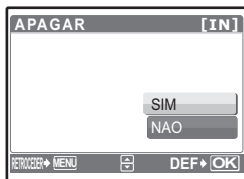
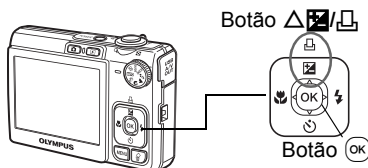

Funcionamento básico

Botões Modo Fotografia

No modo Fotografia, utilize estes botões de modo a ter um acesso rápido a algumas das funções mais utilizadas.

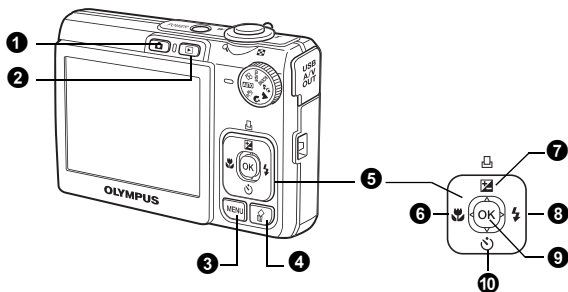

- 1 Botão (Fotografia)**
Selecciona o modo fotografia.
- 2 Botão (Reprodução)**
Selecciona o modo reprodução.
- 3 Botão MENU**
Visualiza o menu principal.
- 4 Botão (Apagar)**
Selecciona a imagem que pretende eliminar no modo reprodução.
- 5 Selector em cruz ()**
Selecciona cenas, imagens a reproduzir e itens de menu.
- 6 Botão (Modo Macro)**
Activa o modo macro ou super macro para fotografar imagens em grande plano.
- 7 Botão (Compensação da exposição/Imprimir)**
No modo fotografia, premir este botão para ajustar o valor de compensação da exposição, que afecta o brilho da imagem.
- 8 Botão (Modo Flash)**
Selecciona 4 modos de flash - AUTO, (Redução olhos vermelhos), (Activação Forçada) ou (Flash desligado).
- 9 Botão (OK)**
Confirma as definições.
- 10 Botão (Temporizador)**
Define o temporizador para fotografar aproximadamente 12 segundos depois de se premir o disparador.

Pt

Modos Cena

Esta função permite alterar o **SCENE** (modo cena) mediante o tema fotográfico.

- 1 Coloque o selector de modo em **SCENE**.

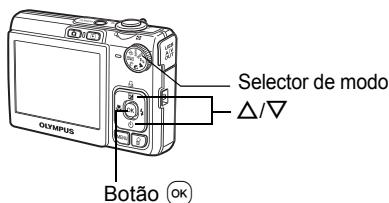

- 2 Premir Δ/∇ para seleccionar a Cena e premir **OK**.

Modos Cena disponíveis

- DESPORTO
- AUTO-RETRATO
- ATRÁS DE VIDRO
- LEILÕES
- SOB ÁGUA MACRO^{*1}
- INTERIORES
- PÔR-DO-SOL
- CULINÁRIA
- SOB ÁGUA AMPLO.1^{*1}
- VELA
- FOGO DE ARTIFÍCIO
- DOCUMENTOS
- SOB ÁGUA AMPLO.2^{*1}



*1 Disponível apenas para o modelo FE-230/X-790.



Modo Macro

- Este modo permite tirar fotografias a uma distância de 10 cm, com o modelo FE-230/X-790, ou 20 cm, ou com o FE-240/X-795. (na posição grande angular)
- Utilize este modo para tirar fotografias a uma distância de 5 cm, com o modelo FE-230/X-790, ou 3 cm, com o FE-240/X-795. No modo , a posição da objectiva do zoom é fixada.

- 1 Premir o botão repetidamente para seleccionar ou e premir **OK**.



Modos de Flash

- 1 Premir o botão  repetidamente de modo a seleccionar o modo flash e premir .
- 2 Premir o disparador até meio.
 - Quando o flash estiver definido para disparar, a marca  ilumina-se.
- 3 Premir totalmente o disparador para fotografar.

Ícone	Modo Flash	Descrição
Sem indicação	Flash automático	O flash dispara automaticamente em condições de luz fraca ou contraluz.
	Flash de redução do efeito olhos vermelhos	O modo flash de redução do efeito de olhos vermelhos reduz significativamente este fenómeno, emitindo pré-flashes antes de disparar o flash habitual.
	Activação forçada	O flash dispara independentemente da luz disponível.
	Flash desligado	O flash não dispara mesmo em situações de luz fraca.

Pt

Temporizador

- 1 Premir o botão  para seleccionar  e premir .
- 2 Premir totalmente o disparador para fotografar.
 - A luz do temporizador acende-se durante aproximadamente 10 segundos, depois de se premir o disparador, em seguida começa a piscar. Depois de piscar durante aproximadamente 2 segundos, a imagem é fotografada.

Luz temporizador



Função Economia Energia

- De modo a economizar a bateria, a câmara entra automaticamente no modo descanso e deixa de funcionar caso não seja usada durante aproximadamente 3 minutos. Premir o botão disparador ou a alavanca de zoom para reactivar a câmara.
- Se a câmara não for usada durante aproximadamente 12 minutos depois de entrar no modo descanso, a objectiva retrair-se-á automaticamente e a câmara desliga-se. Para retomar o funcionamento, ligar novamente a câmara.

Menus e definições

Menu principal

- 1 Premir o botão **MENU** de modo a visualizar o menu principal no monitor.
- 2 Usar o selector em cruz ($\Delta \nabla \triangleleft \triangleright$) para seleccionar itens de menu.



Botão **MENU**

MENU

Menu principal no modo fotografia

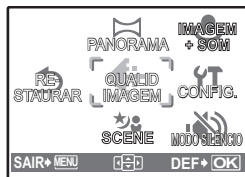

QUALID IMAGEM

Define a qualidade e resolução.

PANORAMA

Cria uma imagem panorâmica.

RESTAURAR

Reinicia as predefinições de origem.

SCENE

Selecione a cena de acordo com o objecto e as condições de disparo.

MODO SILÊNCIO

Desliga os sons de funcionamento, sons de aviso, som do obturador etc. ao fotografar e reproduzir.

CONFIG.

Define a data e a hora, idioma e outras definições.

IMAGEM + SOM/VÍDEO C/SOM

Grava som durante o disparo.

Pt

Apagar todas as imagens

- 1 Premir o botão **MENU** para visualizar o menu principal no modo reprodução.
- 2 Seleccionar [APAGAR], [APAG IMAGS] e premir **OK**.
- 3 Seleccionar [SIM] e premir **OK**.
 - Todas as imagens serão apagadas.



Ligar a câmara

Reproduzir numa TV

Usar o cabo AV fornecido com a câmara para reproduzir as imagens gravadas na sua TV. Pode reproduzir fotografias e vídeos.

- 1 Deve certificar-se de que a TV e a câmara estão desligadas. Ligar o conector múltiplo na câmara ao terminal de entrada de vídeo na TV usando o cabo AV.

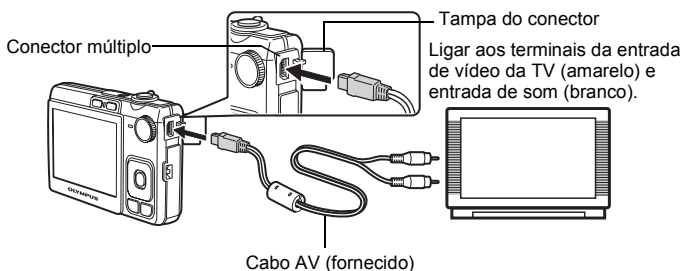

- 2 Ligar a TV e defini-la no modo entrada de vídeo.
 - Para obter mais informações sobre como alterar para entrada de vídeo, consulte o manual de instruções da sua TV.
- 3 Ligar a câmara e premir botão o para seleccionar o modo reprodução.
 - A última imagem fotografada é visualizada na TV. Usar o selector em cruz (>>>>) para seleccionar a imagem que pretende visualizar.

Impressão directa (PictBridge)

Usando o cabo USB fornecido, poderá conectar a sua câmara directamente a uma impressora PictBridge compatível para imprimir. Poderá imprimir uma imagem com uma operação simples.

- 1 No modo reprodução, a imagem a imprimir é visualizada no ecrã.
- 2 Ligar uma extremidade do cabo USB fornecido ao conector múltiplo da câmara e a outra extremidade ao conector USB da câmara.

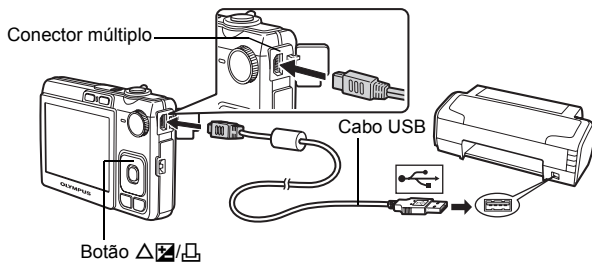

Pt

- 3 Premir o botão Δ/OK/OK.
 - A impressão começa.
 - Depois de concluída, desligue o cabo USB da câmara visualizando o ecrã de selecção da imagem.



Transferir imagens

a. Instalar o software

- 1 Introduzir o CD-ROM OLYMPUS Master.
- 2 **Windows:** Fazer clique no botão "OLYMPUS Master 2".
Macintosh: Fazer duplo clique no ícone "Setup".
- 3 Seguir as instruções no ecrã.

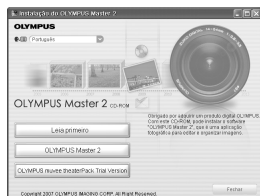

b. Ligar a câmara ao computador

- 1 Ligar a câmara e computador usando o cabo USB (fornecido).
 - O ecrã ligar-se-á automaticamente.

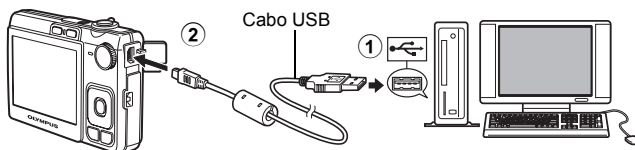

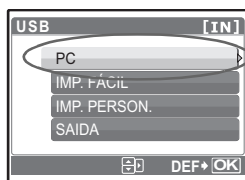

- 2 Seleccionar [PC] no ecrã e premir [OK].



- O seu PC reconhecerá a câmara como uma unidade de armazenamento amovível.

Pt

c. Transferir imagens para o computador

- 1 Agora, com a câmara ligada, abrir o OLYMPUS Master.
- 2 Fazer clique em "Transferir Imagens"  na janela de navegação e, depois, em "Da câmara"  .



- 3 Seguir as instruções no ecrã.

Dicas

- Para obter informação mais detalhada relativamente à configuração e utilização da câmara, consultar o "Manual avançado" da câmara fornecido com o CD-ROM.
- Para obter mais informações, consulte o ficheiro "Help" (Ajuda) no software OLYMPUS Master.

Software OLYMPUS Master

Software OLYMPUS Master: Usar este software para transferir imagens da câmara, visualizar, organizar, retocar, enviar por e-mail e imprimir as suas imagens digitais e vídeos e muito mais!



● Requisitos do Sistema

SO	Windows 2000 Professional/XP Home Edition/XP Professional/Vista ou Mac OS X (10.3 ou superior)
CPU	Pentium III 500 MHz/Power PC G3 500 MHz/Intel Core Solo/Duo 1.5 GHz, ou superior
RAM	256 MB ou superior
Disco rígido	500 MB ou mais de espaço disponível
Ligação	Porta USB/porta IEEE 1394
Ecrã	Resolução de 1024 × 768 pixels ou superior com no mínimo 65.536 cores (Windows), 32.000 cores (Macintosh)
Outro	Internet Explorer 6 ou superior (Windows), Safari 1.0 ou superior, QuickTime 6 ou superior (Macintosh)

Para obter a informação de suporte mais recente, visite o sítio da web da Olympus (<http://www.olympus.com/>)



Registo do utilizador

Registe a sua câmara ao instalar o OLYMPUS Master de modo a activar a sua garantia, receber avisos para actualizações de software e firmware da câmara, e muito mais.

Pt

Especificações

● Câmara

Tipo de produto	: Câmara Digital (para fotografar e visualizar)
Sistema de gravação	
Fotografias	: Gravação Digital, JPEG (de acordo com a Norma de concepção para sistemas de ficheiros de câmara (DCF))
Normas aplicáveis	: Exif 2.2, Digital Print Order Format (DPOF), PRINT Image Matching III, PictBridge
Som com fotografia	: Formato Wave
Vídeo	: AVI Motion JPEG
Memória	: Memória interna xD-Picture Card (16 MB – 2 GB) (Type H/M, Standard)
Número de pixels efectivos	: 7.100.000 pixels
Dispositivo de captação de imagens	: CCD de 1/2,5" (filtro de cor primário), 7.400.000 pixels (brutos)
Objectiva	: FE-230/X-790: Objectiva Olympus 6,3 a 18,9 mm, f3,1 a 5,9 (equivalente a 38 a 114 mm numa câmara 35 mm) FE-240/X-795: Objectiva Olympus 6,4 a 32 mm, f3,3 a 5,0 (equivalente a 38 a 190 mm numa câmara 35 mm)
Sistema fotométrico	: Medição ESP digital
Velocidade obturador	: 4 a 1/2000 seg.
Amplitude de focagem	: FE-230/X-790: 0,6 m a ∞ (W), 1,0 m a ∞ (T) (modo normal) 0,1 m a ∞ (W), 0,6 m a ∞ (T) (modo macro) 0,05 m (modo super macro) FE-240/X-795: 0,7 m a ∞ (modo normal) 0,2 m a ∞ (W), 0,6 m a ∞ (T) (modo macro) 0,03 m (modo super macro)
Ecrã	: Monitor LCD a cores de 2,5" TFT, 115.000 pixels
Conector exterior	: Conector USB, ficha A/V OUT (conector múltiplo)
Sistema de calendário automático	: 2000 até 2099
Ambiente de funcionamento	
Temperatura	: 0°C a 40°C (funcionamento)/ -20°C a 60°C (armazenamento)
Humidade	: 30% a 90% (funcionamento)/ 10% a 90% (armazenamento)
Alimentação	: Uma bateria de iões de lítio Olympus (LI-42B/LI-40B)

Dimensões	: FE-230/X-790: 90,5 mm (L) × 55,0 mm (A) × 16,5 mm (P) (excepto saliências) FE-240/X-795: 93,5 mm (L) × 56,0 mm (A) × 20,0 mm (P) (excepto saliências)
Peso	: FE-230/X-790: 105 g sem bateria e cartão FE-240/X-795: 115 g sem bateria e cartão

● **Bateria de íões de lítio (LI-42B)**

Tipo de produto	: Bateria recarregável de íões de lítio
Voltagem normal	: CC 3,7 V
Capacidade padrão	: 740 mAh
Duração da bateria	: Aprox. 300 cargas completas (varia mediante a utilização)
Ambiente de funcionamento	
Temperatura	: 0°C a 40°C (carregamento)/ -10°C a 60°C (operação) -20°C a 35°C (armazenamento)
Dimensões	: 31,5 × 39,5 × 6 mm
Peso	: Aprox. 15 g

Pt

● **Carregador de bateria (LI-40C)**

Requisitos de energia	: CA 100 a 240 V (50 a 60 Hz) 3,2 VA (100 V) a 5,0 VA (240 V)
Saída	: CC 4,2 V, 200 mA
Tempo de carregamento	: Aprox. 300 min.
Ambiente de funcionamento	
Temperatura	: 0°C a 40°C (funcionamento)/ -20°C a 60°C (armazenamento)
Dimensões	: 62 × 23 × 90 mm
Peso	: Aprox. 65 g

O design e as especificações estão sujeitas a alterações sem aviso prévio.

Precauções de segurança



CUIDADO

NÃO ABRIR, PERIGO DE
CHOQUE ELÉCTRICO



CUIDADO: PARA REDUZIR O RISCO DE CHOQUE ELÉCTRICO, NÃO RETIRE A TAMPÃO (OU COBERTURA POSTERIOR). NÃO TOQUE NAS PARTES INTERNAS CONTACTE OS SERVIÇOS TÉCNICOS QUALIFICADOS DA OLYMPUS.



O ponto de exclamação dentro de um triângulo, alerta o utilizador sobre a presença de partes importantes para o funcionamento e manutenção (serviços técnicos). Ver as instruções que acompanham este produto.



PERIGO

Se o produto for utilizado sem observância das informações acompanhadas deste símbolo, poderão ocorrer lesões graves ou morte.



ADVERTÊNCIA

Se o produto for utilizado sem observância das informações acompanhadas deste símbolo, poderão ocorrer lesões ou morte.



PRECAUÇÃO

Se o produto for utilizado sem observância das informações acompanhadas deste símbolo, poderão ocorrer lesões pessoais, danos no equipamento ou a perda de dados importantes.

ATENÇÃO!

PARA REDUZIR O RISCO DE FOGO OU DE CHOQUES ELÉCTRICOS, NÃO EXPONHA ESTE EQUIPAMENTO À CHUVA, EM CONTACTO COM LÍQUIDOS OU EM LOCAIS COM HUMIDADE.

Pt

Precauções Gerais

Leia todas as instruções — Antes de utilizar o produto, leia todas as instruções de funcionamento. Guarde todos os manuais e instruções de segurança para futuras consultas.

Limpeza — Desligue sempre da tomada, antes de o limpar. Utilize apenas um pano macio para limpeza. Para limpar, nunca use nenhum tipo de líquido ou aerossol, ou solvente orgânico.

Acessórios — Para sua segurança e para evitar danos no produto, utilize apenas acessórios recomendados pela Olympus.

Água e Humidade — Para consultar as precauções sobre os produtos com características à prova de água, leia as respectivas secções.

Localização — Para evitar danos no produto, monte-o com segurança sobre um tripé, estante ou suporte estável.

Fonte de energia — Ligue este aparelho à fonte de energia designada para ele.

Objectos estranhos — Para evitar lesões pessoais, nunca insira objectos metálicos dentro do produto.

Calor — Nunca use ou guarde este produto perto de fontes de calor, tais como radiadores, aquecedores ou qualquer tipo de equipamento ou ferramenta que produza calor, incluindo amplificadores de som.

ADVERTÊNCIA

- **Não utilize a câmara perto de gases inflamáveis ou explosivos.**
- **Não utilize o flash a curta distância das pessoas (especialmente crianças, adolescentes, etc.).**
 - Deverá manter-se a uma distância mínima de 1 m da face das pessoas. Se disparar o flash muito próximo dos olhos da pessoa, pode causar uma perda momentânea da visão.
 - Mantenha as crianças e adolescentes fora do alcance da câmara.
 - Utilize e guarde sempre a câmara fora do alcance das crianças e menores, para prevenir as seguintes situações de perigo que poderiam causar sérias lesões:
 - Ficar preso na correia da câmara, ocasionando asfixia.
 - Ingerir acidentalmente uma pilha ou uma pequena peça.
 - Disparar o flash acidentalmente sobre os seus próprios olhos ou sobre os olhos de uma criança.
 - Lesionar-se acidentalmente com as peças móveis da câmara.
- **Não olhe para o sol ou para luzes fortes através da câmara.**
- **Não utilize nem guarde a câmara em locais com pó ou humidade.**
- **Durante o disparo, não obstrua o flash com a mão.**

PRECAUÇÃO

- **Interrompa imediatamente a utilização da câmara se notar algum cheiro, ruído ou fumo estranho a sair.**
 - Nunca remova as pilhas com as mãos desprotegidas, pois pode provocar fogo ou queimar as suas mãos.
- **Nunca segure nem opere a câmara com as mãos molhadas.**
- **Não deixe a câmara em locais onde possa estar sujeita a elevadas temperaturas.**
 - Caso contrário, as peças da câmara podem deteriorar-se e, em algumas circunstâncias, provocar incêndio na câmara. Não usar o carregador se estiver coberto (por exemplo, com um cobertor). Caso contrário, pode provocar sobreaquecimento ou fogo.
- **Manuseie a câmara com cuidado de modo a evitar alguma queimadura provocada por baixo calor.**
 - Quando a câmara contém peças metálicas, pode ocorrer o sobreaquecimento das mesmas, resultando em queimaduras provocadas por baixo calor. Ter em atenção o seguinte:
 - Quando usada durante um longo período, a câmara ficará quente. Se continuar a segurar a câmara nestas condições, pode ocorrer uma queimadura de baixo calor.
 - Em locais sujeitos a temperaturas extremamente frias, a temperatura do corpo da câmara pode ser inferior à temperatura ambiente. Se possível, usar luvas ao manusear a câmara a baixas temperaturas.
- **Tenha cuidado com a correia.**
 - Quando transportar a câmara tenha cuidado com a correia, já que, uma vez que é fácil enlaçá-la em objectos soltos em objectos soltos e causar sérios danos.

Precauções a respeito da manipulação das pilhas

Siga estas importantes indicações para evitar que ocorram fugas de líquido, sobre-aquecimento, incêndio ou explosão das pilhas ou para evitar choques eléctricos ou queimaduras.

PERIGO

- Utilize somente a bateria de íões de lítio e o carregador apropriado de marca Olympus. Carregar a bateria com o carregador especificado. Não usar outros carregadores.
- Nunca aqueça ou queime as pilhas.
- Tome precauções ao transportar ou guardar as pilhas a fim de evitar que entrem em contacto com objectos metálicos, tais como agrafos, ganchos, jóias, etc.
- Nunca guarde as pilhas em lugares onde fiquem expostas à luz solar directa ou sujeitas a altas temperaturas ou no interior de um veículo com aquecimento, perto de uma fonte de calor, etc.
- Para evitar que ocorram fugas de líquido das pilhas ou danos dos seus terminais, siga cuidadosamente todas as instruções respeitantes ao uso das pilhas. Nunca tente desmanchar a pilha nem modificá-la de nenhuma maneira, por soldadura, etc.
- Se o líquido da pilha penetrar nos seus olhos, lave-os de imediato com água corrente fresca e limpa, procurando assistência médica logo em seguida.
- Guarde as pilhas sempre fora do alcance das crianças. Se um menor ingerir uma pilha acidentalmente, procure assistência médica imediatamente.

ADVERTÊNCIA

- Mantenha as pilhas sempre secas.
- Para evitar fugas de líquido, sobre-aquecimento, incêndio ou explosão, utilize exclusivamente as pilhas recomendadas para este produto.
- Insira a bateria cuidadosamente conforme descrito nas instruções de operação.
- Se baterias recarregáveis não forem recarregadas dentro do tempo especificado, pare com o carregamento e não use.
- Não use uma bateria se estiver rachada ou quebrada.
- Se uma bateria vazar, se ficar sem cor, deformada ou se apresentar alguma outra anormalidade, pare de usar a câmara.
- Se cair líquido da bateria na sua roupa, tire-a e lave logo a área afectada com água corrente, fria e limpa. Se o líquido queimar a sua pele, procure cuidados médicos imediatamente.
- Nunca sujeite as baterias a pancadas fortes ou a vibrações contínuas.

PRECAUÇÃO

- Antes de carregar, sempre inspecione a bateria cuidadosamente para ver se há vazamentos, descoloração, deformação ou qualquer outra anormalidade.
- A bateria pode ficar quente devido ao uso prolongado. Para evitar queimaduras menores, não remova a bateria imediatamente depois de usar a câmara.
- Retire sempre a bateria da câmara antes de guardá-la por um longo período.

Para Clientes na América do Norte e do Sul

Para Clientes nos EUA

Declaração de Conformidade

Modelo Número : FE-230/X-790

FE-240/X-795

Nome Comercial : OLYMPUS

Parceiro Responsável: OLYMPUS IMAGING AMERICA INC.

Morada : 3500 Corporate Parkway, P.O. Box 610, Center Valley,

PA 18034-0610. U.S.A.

Telefone Número : 484-896-5000

Testada Em Conformidade Com O Standard FCC

PARA USO DOMÉSTICO OU NO ESCRITÓRIO

Este aparelho está em conformidade com a Capítulo 15 das Regras FCC. O seu funcionamento está sujeito a duas condições:

(1) Este aparelho não pode causar perigo de interferência.

(2) Este aparelho pode receber qualquer tipo de interferência, inclusive interferências que possam originar o seu mau funcionamento.

Para Clientes no Canadá

Este aparelho digital da Classe B está em conformidade com a Regulamentação Canadiana para Equipamentos Causadores de Interferências.

Marcas Comerciais

- A IBM é uma marca comercial registada da International Business Machines Corporation.
- Microsoft e Windows são marcas comerciais registadas da Microsoft Corporation.
- Macintosh é uma marca comercial registada da Apple Computers Inc.
- xD-Picture Card TM é uma marca registada.
- Todas as outras companhias e nomes de produtos são marcas comerciais registadas e/ou marcas comerciais dos respectivos fabricantes.
- Os standards referidos neste manual para os sistemas de ficheiro da câmara são os standards DCF (“Design Rule for Camera File System”) estipulados pela JEITA (“Japan Electronics and Information Technology Industries Association”).

Pt

Memo

Memo

OLYMPUS®

<http://www.olympusamerica.com/>

OLYMPUS IMAGING AMERICA INC.

3500 Corporate Parkway, P.O. Box 610, Center Valley, PA 18034-0610, U.S.A. Tel. 484-896-5000

Technical Support (USA)

24/7 online automated help: <http://www.olympusamerica.com/support>

Phone customer support: Tel. 1-888-553-4448 (Toll-free)

Our phone customer support is available from 8 am to 10 pm (Monday to Friday) ET

E-Mail: distec@olympus.com

Olympus software updates can be obtained at: <http://www.olympusamerica.com/digital>

To find the nearest Service Centers, please visit: <http://www.olympusamerica.com/digital>,

and click on the Worldwide Warranty icon at the bottom of the page.

Service Centers

U.S.A.:

California Olympus Imaging America Inc.

10805 Holder Street Suite 170
Cypress, CA 90630-5145
Tel: (888) 553-4448

New York Olympus Imaging America Inc.

400 Rabro Drive
Hauppauge, NY 11788-4258
Tel: (888) 553-4448

Canada:

Mississauga Olympus Canada Inc.

Consumer Products Group
151 Telson Road
Markham, Ontario Canada L3R 1E7
Tel. 1-866-267-3039

Mexico: Olympus Imaging de Mexico S.A. de C.V.

WTC Mexico,
Montecito No.38 - Lobby - Office 3
Col. Napolis, Mexico D.F. 03810
Tel. (01800)800-2128
E-mail: pedro.jimenez@olympus.com

Argentina:

Jesus Labrador S.A.

Paraguay 755 PB, C1057 AAI Buenos Aires
Tel: (011) 4313-3174 Fax: (011) 4312-5239
E-Mail: jesuslabrador@speedy.com.ar

Jesus Labrador S.A.

Sucursal Mitre, Bartolome Mitre 860
C1036AAP Buenos Aires Tel: (011) 4331-1227
E-mail: jesuslabrador@speedy.com.ar

Brazil:

Rio de Janeiro Assistec

Rua Uruguaiana, 94-Sobrelaja
Centro-Rio de Janeiro CEP 20050-091
Tel: (021) 2242-3236 Fax: (021) 2242-3236
E-Mail: rio@assistecs.com.br

Sao Paulo Assistec

Rua Avanhandava 126, 3 Andar
Consolação, São Paulo
Tel: (011) 3123-3100 Fax: (011) 3214-0706
E-mail: ASSISTECSS@UOL.COM.BR

Assistec

Filial Shopping Eldorado
Av. Rebouças 3970, 1 Subsolo, Loja 1035
Pinheiros, Sao Paulo
Tel: (011) 3815-3054 Fax: (011) 3814-4398
E-mail: ASSISTECSS@UOL.COM.BR

Chile:

REIFSCHEIDER S.A.

Camino El Conquistador del Monte 5024
Huechuraba, Santiago
Tel: 56-2-6781200
Fax: 56-2-6781202
E-mail : olympus@reifschneider.cl,
serviciotecnico@reifschneider.cl

Colombia:

CV Tronica LTDA

Calle 68 No 12-57, Bogota
Tel: (0571) 235-7260/348-1573
Fax: (0571) 348-1574
E-mail: servicio@cvtronica.com

Panama:

FOTOSER

Edif. El Paical, Oficina No3, P.A.
Urb. Herbruger, Transistmica
(Detras del S/M Riba Smith),
Tel/Fax: (507) 261-0436
E-mail: rearanda@rocketmail.com

Uruguay:

Fotocamara S.R.L.

Rondeau 1470 Montevideo
Tel: (02) 900-2004 Fax: (02) 900-8430
E-mail: FOTOCAM@ADINET.COM.UY

Venezuela:

Micron C.A.

4ta. transversal Urb. Horizonte,
Edificio América, Mezanine, Caracas 1070-A
Tel: (0212) 238-3526 Fax: (0212) 239-8598
E-mail: gullermolandaeta@micron.com.ve