

OLYMPUS[®]

DIGITAL CAMERA

VR-330/D-730

VR-320/D-725

VR-310/D-720

Instruction Manual

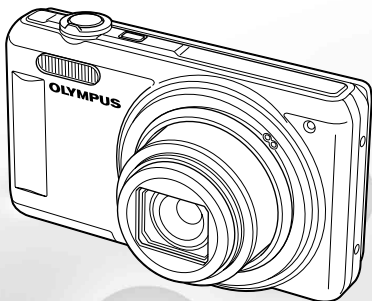

- Thank you for purchasing an Olympus digital camera. Before you start to use your new camera, please read these instructions carefully to enjoy optimum performance and a longer service life. Keep this manual in a safe place for future reference.
- We recommend that you take test shots to get accustomed to your camera before taking important photographs.
- In the interest of continually improving our products, Olympus reserves the right to update or modify information contained in this manual.
- The screen and camera illustrations shown in this manual were produced during the development stages and may differ from the actual product. Unless otherwise specified, the explanation about these illustrations is provided for VR-330/D-730.

Step 1 Checking the contents of the box



Digital camera



Strap



LI-42B Lithium
Ion Battery



F-2AC
USB-AC adapter



USB cable



AV cable



OLYMPUS
Setup
CD-ROM

Other accessories not shown: warranty card
Contents may vary depending on purchase location.

Step 2 Preparing the Camera

"Preparing the Camera" (p. 12)

Step 3 Shooting and Playing Back Images

"Shooting, Viewing, and Erasing" (p. 19)

Step 4 How to Use the Camera

"Camera Settings" (p. 3)

Step 5 Printing

"Direct printing (PictBridge)" (p. 48)
"Print Reservations (DPOF)" (p. 52)

Contents

- **Names of Parts** 8
- **Menus for Playback, Editing, and Printing Functions** 38
- **Preparing the Camera** 12
- **Menus for Other Camera Settings** 41
- **Shooting, Viewing, and Erasing** 19
- **Printing** 48
- **Using Shooting Modes** 26
- **Usage Tips** 55
- **Using Shooting Functions** 30
- **Appendix** 60
- **Menus for Shooting Functions** 34

Camera Settings

Using the Direct Buttons

Frequently used functions can be accessed using the direct buttons.



Zoom lever (p. 21, 24)



Shutter button (p. 20)



⏪ button (shooting movies) (p. 20)



▶ button (switch between shooting and playback) (p. 20, 22)



MENU button (p. 5)



❓ button (menu guide) (p. 25)

Arrow pad

△ (up) /
INFO button (change information display) (p. 22, 24)

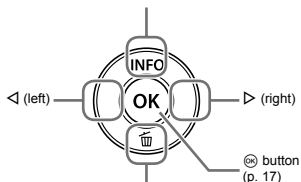

▽ (down) /
🗑️ button (erase) (p. 23)

The symbols △ ▽ ◀ ▶ displayed for image selections and settings indicate that the arrow pad is to be used.



Using the Menu

Use the menu to change camera settings such as the shooting mode.

⚠ There may be menus that are unavailable depending on other related settings or the **SCN** mode (p. 26).

Function menu

Press \triangleleft during shooting to display the function menu. The function menu is used to choose the shooting mode and provides access to frequently used shooting settings.

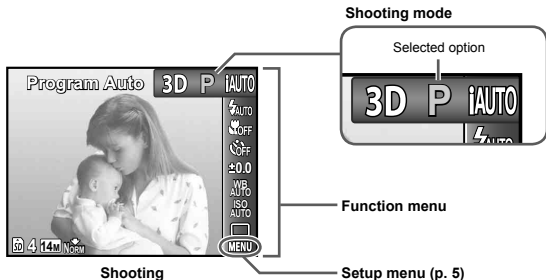

To select the shooting mode

Use \triangleleft \triangleright to select a shooting mode and press the OK button.

To select the function menu

Use \triangle ∇ to select a menu and use \triangleleft \triangleright to select a menu option. Press the OK button to set the function menu.

Setup menu

Press the **MENU** button during shooting or playback to display the setup menu. The setup menu provides access to a variety of camera settings, including options not listed in the function menu, display options, and the time and date.

1 Press the MENU button.

- The setup menu is displayed.

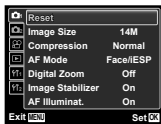

2 Press \triangleleft to highlight the page tabs. Use \triangle / ∇ to select the desired page tab and press \triangleright .

Page tab



Submenu 1



3 Use \triangle / ∇ to select the desired submenu 1 and then press the \odot button.

Submenu 2



4 Use \triangle / ∇ to select the desired submenu 2 and then press the \odot button.

- Once a setting is selected, the display returns to the previous screen.
- ! There may be additional operations. "Menu Settings" (p. 34 to 47)



5 Press the MENU button to complete the setting.

Menu Index

Menus for Shooting Functions

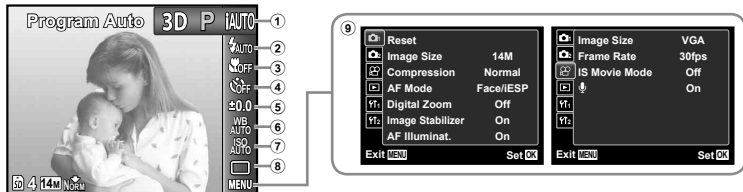

- ① Shooting mode
 - P** (Program Auto)p. 19
 - iAUTO** (iAUTO)p. 26
 - SCN** (Scene Mode)p. 26
 - MAGIC** (Magic Filter)p. 27
 - ∞** (Panorama)p. 28
 - 3D** (3D Photo)*1p. 25
- ② Flashp. 30
- ③ Macrop. 30
- ④ Self-timerp. 31
- ⑤ Exposure compensation...p. 31
- ⑥ White balance.....p. 32
- ⑦ ISOp. 32
- ⑧ Drivep. 33
- ⑨ **MENU** (Setup) ▶
 - 📷** (Shooting menu 1)
 - Resetp. 34
 - Image Sizep. 34
 - Compressionp. 34
 - AF Mode.....p. 35
 - Digital Zoomp. 36
 - Image Stabilizer.....p. 36
 - AF Illuminat.p. 37
 - 📷** (Shooting menu 2)
 - Icon Guidep. 37
 - Date Stampp. 37
 - 🎥** (Movie menu)
 - Image Sizep. 35
 - Frame Ratep. 35
 - IS Movie Modep. 36
 - 🎤 (Movie sound recording)p. 37

*1 VR-330/D-730 only

Menus for Playback, Editing, and Printing Functions



- ① (Playback menu)
- | | |
|-------------------|-----------|
| Slideshow | p. 38 |
| Edit | p. 38, 39 |
| Erase | p. 39 |
| Print Order | p. 40 |
| (Protect) | p. 40 |
| (Rotate) | p. 40 |

Menus for Other Camera Settings

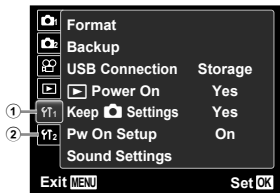

- ① (Settings 1)
- | | |
|--------------------------------|-------|
| Memory Format/ Format | p. 41 |
| Backup | p. 41 |
| USB Connection | p. 41 |
| Power On | p. 42 |
| Keep Settings | p. 42 |
| Pw On Setup | p. 42 |
| Sound Settings | p. 42 |
- ② (Settings 2)
- | | |
|------------------------------|-------|
| Pixel Mapping | p. 42 |
| (Monitor) | p. 43 |
| TV Out ¹ | p. 43 |
| Video Out ² | p. 46 |
| Power Save | p. 47 |
| (Language) | p. 47 |
| (Date/time) | p. 47 |
| World Time | p. 47 |

¹ VR-330/D-730 only

² VR-320/D-725 and VR-310/D-720 only

Names of Parts

Camera unit

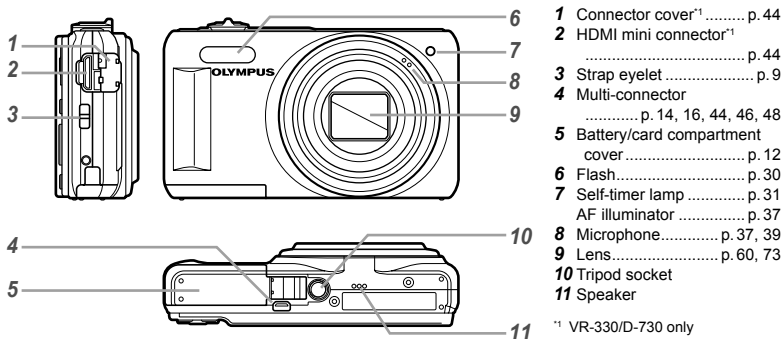

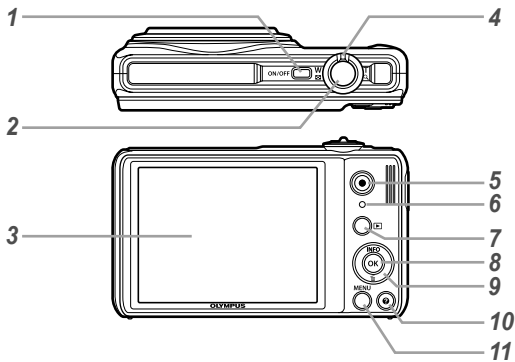

- 1 ON/OFF button p. 17, 19
- 2 Shutter button p. 20
- 3 Monitor p. 19, 55
- 4 Zoom lever p. 21, 24
- 5 \odot button
(shooting movies) p. 20
- 6 Indicator lamp p. 14, 16
- 7 \triangleright button
(switch between shooting
and playback) p. 20, 22
- 8 \odot button (OK) p. 17
- 9 Arrow pad p. 3
- INFO button
(change information
display) p. 22, 24
- ? button (erase) p. 23
- 10 ? button (menu guide)
..... p. 25
- 11 MENU button p. 5

Attaching the camera strap

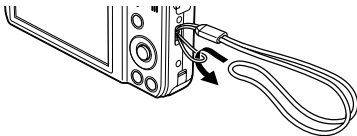

-  Pull the strap tight so that it does not come loose.

Shooting mode display

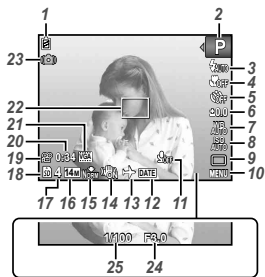

- 1** Battery check p. 16
- 2** Shooting mode p. 19, 26
- 3** Flash p. 30
- Flash standby/flash charge p. 55
- 4** Macro p. 30
- 5** Self-timer p. 31
- 6** Exposure compensation p. 31
- 7** White balance p. 32
- 8** ISO p. 32
- 9** Drive p. 33
- 10** Setup menu p. 5
- 11** Recording with sound (movies) p. 37
- 12** Date stamp p. 37
- 13** World time p. 47
- 14** Image stabilization p. 36
- 15** Compression (still images) p. 34
- 16** Image size (still images) p. 34
- 17** Number of storable pictures (still images) p. 19
- 18** Current memory p. 62
- 19** Movie recording icon p. 20
- 20** Continuous recording length (movies) p. 20
- 21** Image size (movies) p. 35
- 22** AF target mark p. 20
- 23** Camera shake warning
- 24** Aperture value p. 20
- 25** Shutter speed p. 20

Playback mode display

• Normal display



Still image



Movie

• Detailed display

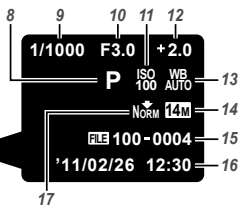
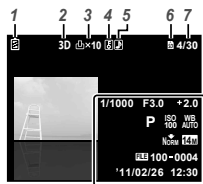

- 1 Battery check..... p. 16
- 2 3D image¹..... p. 25
- 3 Print reservation/number of prints..... p. 52/p. 50
- 4 Protect p. 40
- 5 Adding sound p. 39
- 6 Current memory p. 62
- 7 Frame number/
total number of images
(still images)..... p. 22
Elapsed time/
total recording time
(movies)..... p. 23
- 8 Shooting mode p. 19, 26
- 9 Shutter speed p. 20
- 10 Aperture value p. 20
- 11 ISO p. 32
- 12 Exposure compensation
..... p. 31
- 13 White balance..... p. 32
- 14 Image size p. 34, 35
- 15 File number
- 16 Date and time p. 17
- 17 Compression
(still images)..... p. 34
Frame rate (movies)..... p. 35
- 18 Volume p. 42

¹ VR-330/D-730 only

Preparing the Camera

Inserting the battery and the SD/SDHC memory card (sold separately)

- Always use SD/SDHC memory cards with this camera. Do not insert any other types of memory card.

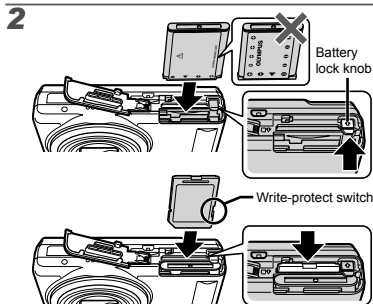
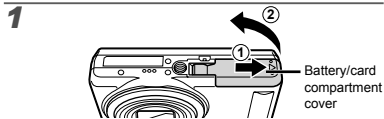

- Insert the battery with the symbol on the same side as the battery lock knob. Damage to the battery exterior (scratches, etc.) may produce heat or an explosion.
- Insert the battery while sliding the battery lock knob in the direction of the arrow.
- Slide the battery lock knob in the direction of the arrow to unlock, and then remove the battery.
- Turn off the camera before opening the battery/card compartment cover.
- When using the camera, be sure to close the battery/card compartment cover.
- Insert the card straight until it clicks into place.
- Do not touch the contact area directly.

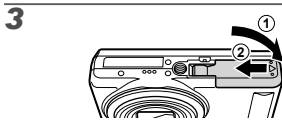

- This camera allows the user to take pictures using the internal memory even when no SD/SDHC memory card (sold separately) is inserted. "Using an SD/SDHC memory card" (p. 61)
- "Number of storable pictures (still images)/Continuous recording length (movies) in the internal memory and SD/SDHC memory cards" (p. 63)

To remove the SD/SDHC memory card

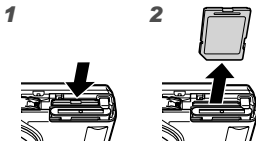

- ❗ Press the card in until it clicks and comes out slightly, then grab the card and pull it out.

Charging the battery and setting up using the supplied CD

Connect the camera to the computer to charge the battery and use the supplied CD for setup.

- ❗ User registration using the supplied CD and installation of [ib] computer software is available on Windows computers only.
- The camera battery can be charged while the camera is connected to a computer.
- The indicator lamp lights during charging and turns off when charging is complete.
- ❗ Charging takes up to 3 hours.
 - ❗ If the indicator lamp does not light, the camera is not correctly connected or the battery, camera, computer, or USB cable may not be functioning as expected.
 - ❗ We recommend that you use a computer equipped with Windows XP (Service Pack 2 or later), Windows Vista, or Windows 7. See "Charging the battery with the supplied USB-AC adapter" (p. 16) if you are using a different computer or wish to charge the battery without using a computer.

Windows

1 Insert the supplied CD in a CD-ROM drive.

Windows XP

- A "Setup" dialog will be displayed.

Windows Vista/Windows 7

- An Autorun dialog will be displayed. Click "OLYMPUS Setup" to display the "Setup" dialog.



- ❗ If the "Setup" dialog is not displayed, select "My Computer" (Windows XP) or "Computer" (Windows Vista/Windows 7) from the start menu. Double-click the CD-ROM (OLYMPUS Setup) icon to open the "OLYMPUS Setup" window and then double-click "Launcher.exe".
- ❗ If a "User Account Control" dialog is displayed, click "Yes" or "Continue".

2 Follow the on-screen instructions on your computer.

- ! If nothing is displayed on the camera screen even after connecting the camera to the computer, the battery may be exhausted. Leave the camera connected to the computer until the battery has charged, then disconnect and reconnect the camera.

Connecting the camera

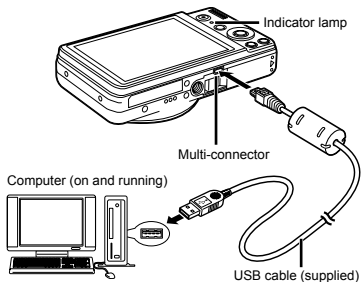

3 Register your Olympus product.

- Click the "Registration" button and follow the on-screen instructions.

4 Install OLYMPUS Viewer 2 and [ib] computer software.

- Check the system requirements before beginning installation.
- Click the "OLYMPUS Viewer 2" or "OLYMPUS ib" button and follow the on-screen instructions to install the software.

OLYMPUS Viewer 2

| | |
|-----------------------|---|
| Operating System | Windows XP (Service Pack 2 or later)/ Windows Vista/Windows 7 |
| Processor | Pentium 4 1.3 GHz or better |
| RAM | 1 GB or more (2 GB or more recommended) |
| Free Hard Drive Space | 1 GB or more |
| Monitor Settings | 1024 × 768 pixels or more Minimum 65,536 colors (16,770,000 colors recommended) |

[ib]

| | |
|-----------------------|--|
| Operating System | Windows XP (Service Pack 2 or later)/ Windows Vista/Windows 7 |
| Processor | Pentium 4 1.3 GHz or better (Pentium D 3.0 GHz or better required for movies) |
| RAM | 512 MB or more (1 GB or more recommended) (1 GB or more required for movies—2 GB or more recommended) |
| Free Hard Drive Space | 1 GB or more |
| Monitor Settings | 1024 × 768 pixels or more Minimum 65,536 colors (16,770,000 colors recommended) |
| Graphics | A minimum of 64 MB video RAM with DirectX 9 or later. |

* See online help for information on using the software.

5 Install the camera manual.

- Click the "Camera Instruction Manual" button and follow the on-screen instructions.

Macintosh

1 Insert the supplied CD in a CD-ROM drive.

- Double-click the CD (OLYMPUS Setup) icon on the desktop.
- Double-click the "Setup" icon to display the "Setup" dialog.



2 Install OLYMPUS Viewer 2.

- Check the system requirements before beginning installation.
- Click the "OLYMPUS Viewer 2" button and follow the on-screen instructions to install the software.



You can make user registration via "Registration" in OLYMPUS Viewer 2 "Help".

OLYMPUS Viewer 2

| | |
|-----------------------|--|
| Operating System | Mac OS X v10.4.11–v10.6 |
| Processor | Intel Core Solo/Duo 1.5 GHz or better |
| RAM | 1 GB or more (2 GB or more recommended) |
| Free Hard Drive Space | 1 GB or more |
| Monitor Settings | 1024 × 768 pixels or more Minimum 32,000 colors (16,770,000 colors recommended) |

* Other languages can be selected from the language combo box. For information on using the software, see online help.

3 Copy the camera manual.

- Click the "Camera Instruction Manual" button to open the folder containing the camera manuals. Copy the manual for your language to the computer.

Charging the battery with the supplied USB-AC adapter

- ❗ The included F-2AC USB-AC adapter (hereafter referred to as USB-AC adapter) differs depending on the region where you purchased the camera.
- ❗ The supplied USB-AC adapter is for charging and playback only. Do not take pictures while the USB-AC adapter is connected to the camera. The camera cannot playback without the battery even when connected to the USB-AC adapter.

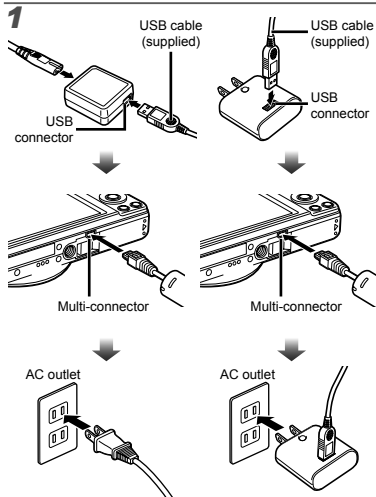

2



- ❗ The battery is not fully charged at the time of purchase. Before use, be sure to charge the battery until the indicator lamp turns off (up to 3 hours).
- ❗ If the indicator lamp does not light, the camera is not correctly connected or the battery, camera, or USB-AC adapter may not be functioning as expected.
- ❗ For details on the battery and the USB-AC adapter, see "The battery and USB-AC adapter" (p. 60).
- ❗ The battery can be charged while the camera is connected to the computer. Charging time varies depending on the performance of a computer. (There may be cases in which it takes approx. 10 hours.)

When to charge the batteries

Charge the battery when the error message shown below appears.

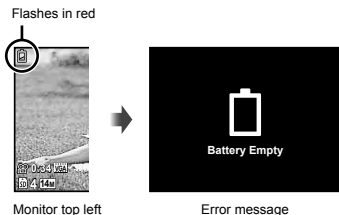

Operation guide

Operation guides displayed at the bottom of the screen indicate that the **MENU** button,  button, or zoom lever should be used.

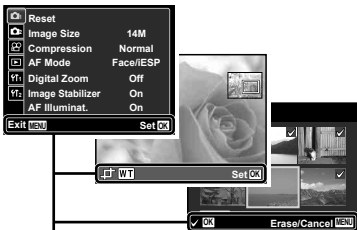

Operation guide

Date, time, time zone, and language

The date and time set here are saved to image file names, date prints, and other data. You can also choose the language for the menus and messages displayed in the monitor.

1 Press the ON/OFF button to turn on the camera.

- The date and time setting screen is displayed when the date and time are not set.

ON/OFF 



Date and time setting screen

2 Use Δ / ∇ to select the year for [Y].



3 Press **▷** to save the setting for [Y].



4 As in Steps 2 and 3, use **△▽◀▶** and the **⊗** button to set [M] (month), [D] (day), [Time] (hours and minutes), and [Y/M/D] (date order).

- ⚠ For a more accurate setting, press the **⊗** button when the time signal hits 00 seconds while setting the minutes.
- ⚠ The menu can be used to change the selected date and time. [**⊗**] (Date/time) (p. 47)

5 Use **◀▶** to select your home time zone and press the **⊗** button.

- Use **△▽** to turn daylight saving time ([Summer]) on or off.



- ⚠ The menu can be used to change the selected time zone. [World Time] (p. 47)

6 Use **△▽◀▶** to select your language and press the **⊗** button.

- ⚠ The menu can be used to change the selected language. [**⊗**] (Language) (p. 47)

Shooting, Viewing, and Erasing

Shooting with the optimum aperture value and shutter speed [Program Auto]

In this mode, automatic shooting settings are activated while also allowing changes to a wide range of other shooting menu functions, such as exposure compensation, white balance, etc. as needed.

- 1 Press the ON/OFF button to turn on the camera.

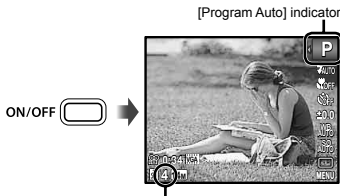

Number of storable still pictures (p. 63)

Monitor (standby mode screen)

- ! If the [Program Auto] indicator is not displayed, press \triangleleft to display the function menu and then set the shooting mode to **P**.
"Using the Menu" (p. 4)

Current shooting mode display



- ! Press the ON/OFF button again to turn off the camera.

- 2 Hold the camera and compose the shot.

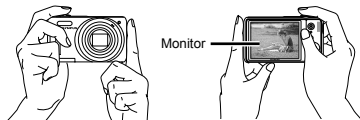

Horizontal grip



Vertical grip

- ! When holding the camera, take care not to cover the flash with your fingers, etc.

3 Press the shutter button halfway down to focus on the subject.

- When the camera focuses on the subject, the exposure is locked (shutter speed and aperture value are displayed), and the AF target mark changes to green.
- The camera was unable to focus if the AF target mark flashes red. Try focusing again.

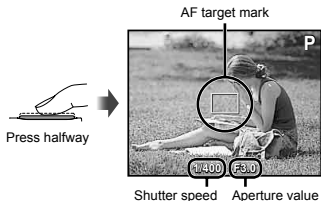

! "Focusing" (p. 57)

4 To take the picture, gently press the shutter button all the way down while being careful not to shake the camera.



To view images during shooting

Pressing the button enables playback of images. To return to shooting, either press the button or press the shutter button halfway down.

Shooting movies

1 Press the button to start recording.

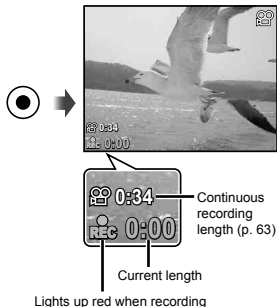

! Sound will also be recorded.

! The shooting mode selected for still photography applies to movies (some shooting modes have no effect).

2 Press the button again to end recording.

! During sound recording, only the digital zoom can be used. To record a movie with optical zoom, set (Movie sound recording) (p. 37) to [Off].

Using the zoom

Turning the zoom lever adjusts the shooting range.

W side T side



Zoom bar



| Model No. | Optical zoom | Digital zoom |
|--------------|--------------|--------------|
| VR-330/D-730 | 12.5 × | 4 × |
| VR-320/D-725 | 12.5 × | 4 × |
| VR-310/D-720 | 10 × | 4 × |

To take larger images [Digital Zoom]

- ⚠ The type and amount of zoom can be identified from the appearance of the zoom bar. The display differs depending on the options selected for [Digital Zoom] (p. 36) and [Image Size] (p. 34).

[Off] selected for [Digital Zoom]:

| Image size | Zoom bar |
|------------|------------------------------------|
| 14M | <p>Optical zoom range</p> |
| Other | <p>Image zoomed and cropped.*1</p> |

[On] selected for [Digital Zoom]:

| Image size | Zoom bar |
|------------|--|
| 14M | <p>Digital zoom range</p> |
| Other | <p>Image zoomed and cropped.*1</p> <p>Digital zoom range</p> |

- *1 If an image size is less than the full resolution after reaching the maximum optical zoom, the camera will automatically resize and crop the image to the selected image size and enter the digital zoom range if [Digital Zoom] is [On].

- ⚠ Photographs taken with the zoom bar displayed in red may appear "grainy."

Changing the shooting information display

The display of the screen information can be changed to best match the situation, for example, the need for a clear view of the screen or for making a precise composition by using the grid display.

1 Press Δ (INFO).

- The displayed shooting information changes in the order shown below each time the button is pressed. "Shooting mode display" (p. 10)

Normal



Detailed



No information



Viewing images

1 Press the \blacktriangleright button.

Number of frames/Total number of images



Playback image

2 Use \triangleleft \blacktriangleright to select an image.



- Hold \blacktriangleright to fast forward and hold \triangleleft to reverse.
- The display size of the images can be changed. "Index view and close-up view" (p. 24)

To play sound recordings

To play sound recorded with an image, select the image and press the \odot button. A M icon appears on images with which sound has been recorded.

- M (still images) (p. 39)



During audio playback

- Press Δ ∇ to adjust volume.

To play back movies

Select a movie, and press the \odot button.



Movie

Operations during movie playback



During playback

| | |
|--------------------------------------|---|
| Pausing and resuming playback | Press the ⏸ button to pause playback. To resume playback during pause, fast forward, or rewind, press the ⏮ button. |
| Fast forward | Press ⏩ to fast forward. Press ⏩ again to increase the fast forward speed. |
| Rewind | Press ⏮ to rewind. The rewinding speed increases each time ⏮ is pressed. |
| Adjusting the volume | Use △ ▽ to adjust the volume. |

Operations during pausing playback

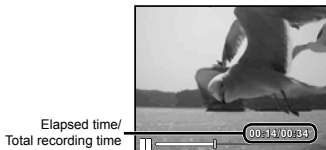

During pause

| | |
|--|--|
| Cueing | Press △ to display the first frame and press ▽ to display the last frame. |
| Advancing and rewinding one frame at a time | Press ⏩ or ⏮ to advance or rewind one frame at a time. Hold ⏩ or ⏮ pressed for continuous advance or rewind. |
| Resuming playback | Press the ⏮ button to resume playback. |

To stop movie playback

Press the **MENU** button.

Erasing images during playback (Single image erase)

- 1 Display the image you want to erase and press **▽** (**🗑**).



- 2 Press **△** **▽** to select [Erase], and press the **Ⓞ** button.

⚠ For erasing multiple images at the same time, see "Erasing images [Erase]" (p. 39).

Index view and close-up view

Index view enables quick selection of a desired image. Close-up view (up to 10× magnification) allows checking of image details.

1 Turn the zoom lever.

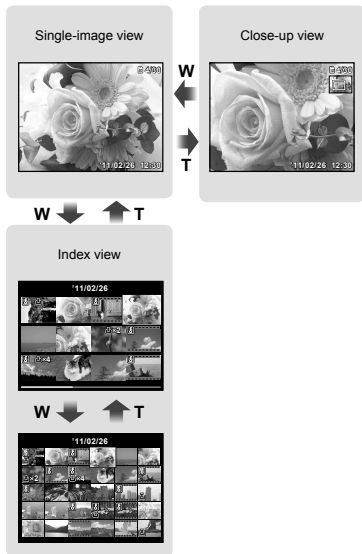

To select an image in index view

Use Δ ∇ \triangleleft \triangleright to select an image, and press the \odot button to display the selected image in single-image view.

To scroll an image in close-up view

Use Δ ∇ \triangleleft \triangleright to move the viewing area.

Changing the image information display

Shooting information settings displayed on the screen can be changed.

1 Press Δ (INFO).

- The displayed image information changes in the order shown below each time the button is pressed.

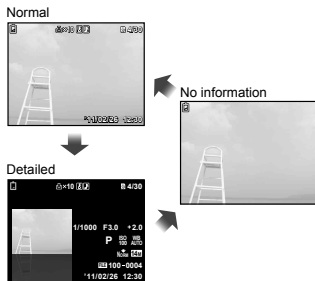

Playing back 3D images (VR-330/D-730)

3D images shot with this camera can be played back on 3D-compatible devices connected to this camera using an HDMI cable (sold separately).

- ! "Shooting 3D images (3D mode)" (p. 29)
- ! When playing back 3D images, read the warnings in the instruction manual for the 3D-compatible devices carefully.

1 Connect the 3D-compatible device and camera using the HDMI cable.

- ! For the connection and setting method, see "Using an HDMI cable" (p. 44).

2 Use Δ ∇ to select [3D Show] and then press the \odot button.

3 Use \triangleleft \triangleright to select the 3D image to play back and then press the \odot button.



- ! To start a slideshow, press the **MENU** button.
To stop the slideshow, press the **MENU** or \odot button.
- ! 3D images are composed of JPEG files and MPO files. If any files are deleted on a computer, playback of 3D images may not be possible.

Using the menu guide

Pressing the \odot button in the setup menu displays a description of the current item.

- ! "Using the Menu" (p. 4)

Using Shooting Modes

To change the shooting mode

The shooting mode (P, iAUTO, SCN, MAGIC, 1, 3D¹) can be changed by using the function menu.

"Using the Menu" (p. 4)

¹ VR-330/D-730 only

! The default settings of the function are highlighted in .

Shooting with automatic settings (iAUTO mode)

According to the scene, the camera automatically selects the optimal shooting mode from [Portrait]/[Landscape]/[Night+Portrait]/[Sport]/[Macro]. This is a fully automatic mode that allows the user to take pictures using the best mode for the shooting scene simply by pressing the shutter button.

1 Set the shooting mode to iAUTO.

The icon changes depending on the scene that the camera automatically selects.



- ! In some cases, the camera may not select the desired shooting mode.
- ! When the camera cannot identify which is the optimal mode, [Program Auto] will be selected.
- ! There are some limitations on settings in iAUTO mode.

Using the best mode for the shooting scene (SCN mode)

1 Set the shooting mode to SCN.



2 Press ∇ to go to the submenu.



3 Use \triangleleft and \triangleright to select the best shooting mode for the scene, and press the \odot button.

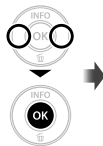

Icon indicating current SCN mode

- ! In **SCN** mode, the optimum shooting settings are pre-programmed for specific shooting scenes. For this reason, some settings cannot be changed in some modes.

| Option | Application |
|---|---|
| Portrait/Landscape/ Night Scene ¹ /Night+Portrait/ Sport/Indoor/Candle ¹ / Self Portrait/Sunset ¹ / Fireworks ¹ /Cuisine/ Documents/Beach & Snow/ Pet | The camera takes a picture using the optimum settings for the scene conditions. |

¹ When the subject is dark, noise reduction is automatically activated. This approximately doubles the shooting time during which no other pictures can be taken.

To take pictures of a moving subject like a pet ([Pet])

- Use <> to select [Pet], and press the OK button to set.
- Hold the camera to align the AF target mark on the subject and press the OK button.
 - When the camera recognizes the subject, the AF target mark automatically tracks the subject movement to focus on it continuously. "To focus on a moving subject continuously (AF Tracking)" (p. 36).

Shooting with special effects (MAGIC mode)

Add an artistic effect to your photo by selecting the desired magic filter.

1 Set the shooting mode to MAGIC.



2 Press ∇ to go to the submenu.

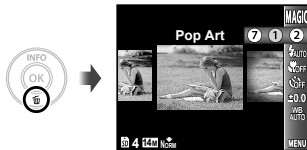

3 Use <> to select the desired effect and then press the OK button to set.

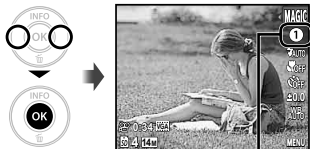

Icon indicating current **MAGIC** mode

| Shooting mode | Option |
|---------------|------------------------|
| Magic Filter | 1 Pop Art |
| | 2 Pin Hole |
| | 3 Fish Eye |
| | 4 Drawing ¹ |
| | 5 Soft Focus |
| | 6 Punk |
| | 7 Sparkle |

¹ Two images are saved, an unmodified image and an image to which the effect has been applied.

- ! In **MAGIC** mode, the optimum shooting settings are pre-programmed for each effect. For this reason, some settings cannot be changed in some modes.

Creating panoramic images (M mode)

Take pictures that can be joined to form a panorama using the supplied software.

- ! The focus, exposure, zoom position (p. 21), and white balance (p. 32) are locked at the first frame.
- ! The flash (p. 30) is fixed to (Flash Off) mode.

1 Set the shooting mode to M.

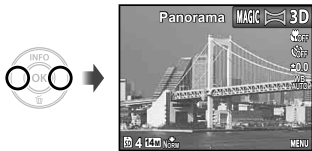

2 Use Δ ∇ \triangleleft \triangleright to select the pan direction.

3 Press the shutter button to take the first frame, and then compose the second shot.

Before first shot



After first shot

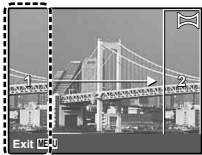

- After the first shot, the area shown in the white frame reappears on the side of the display opposite the pan direction. Frame subsequent photographs so that they overlap with the image on the monitor.

4 Repeat Step 3 until the number of desired frames is taken, and then press the MENU button when finished.

- ! Panorama shooting is possible for up to 10 frames.
- ! For information on creating panoramas, see the online help for the supplied software.

Shooting 3D images (3D mode) (VR-330/D-730)

In this mode, 3D images are shot for viewing on 3D-compatible display devices.

- ! The camera monitor does not display images in 3D.
-

1 Set the shooting mode to 3D.



2 Press the shutter button to take the first shot.

3 Overlap the subject with the image that is faintly displayed in the monitor, and choose the position for the second frame.

4 Press the shutter button to take the second shot.

- ! Depending on the subject or the situation (if the distance between the camera and subject is too short), the image may not look 3D.
- ! The 3D viewing angle varies depending on the subject, etc.
- ! To exit 3D shooting mode without saving an image, press the **MENU** button.

Using Shooting Functions

- ! "Using the Menu" (p. 4)
- ! The default settings of the function are highlighted in .

Using the flash

The flash functions can be selected to best match the shooting conditions.

- 1 Select the flash option in the function menu.

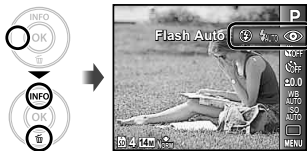

- 2 Use \triangleleft and \triangleright to select the setting option, and press the OK button to set.

| Option | Description |
|------------|---|
| Flash Auto | The flash fires automatically in low-light or backlight conditions. |
| Redeye | Pre-flashes are emitted to reduce the occurrence of red eye in your photos. |
| Fill In | The flash fires regardless of the available light. |
| Flash Off | The flash does not fire. |

Shooting closeups (Macro shooting)

This function enables the camera to focus and shoot subjects at close distances.

- 1 Select the macro option in the function menu.

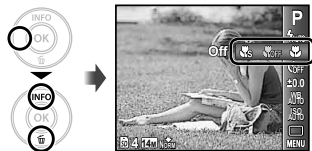

- 2 Use \triangleleft and \triangleright to select the setting option, and press the OK button to set.

| Option | Description |
|---------------------------|---|
| Off | Macro mode is deactivated. |
| Macro | This enables shooting as close as 20 cm/7.9 in. ¹⁾ (90 cm/35.4 in. ²⁾ to the subject. |
| Super Macro ³⁾ | This enables shooting as close as 1 cm/0.4 in. to the subject. |

¹⁾ When the zoom is at the widest (W) position.

²⁾ When the zoom is at the most telephoto (T) position.

³⁾ The zoom is automatically fixed.

- ! The flash (p. 30) and zoom (p. 21) cannot be set during super macro shooting.

Using the self-timer

After the shutter button is pressed all the way down, the picture is taken after a short delay.

- 1 Select the self-timer option in the function menu.



- 2 Use <> to select the setting option, and press the button to set.

| Option | Description |
|--------|--|
| Off | The self-timer is deactivated. |
| 12 sec | The self-timer lamp turns on for approx. 10 seconds, then blinks for approx. 2 seconds, and then the picture is taken. |
| 2 sec | The self-timer lamp blinks for approx. 2 seconds, and then the picture is taken. |

- Self-timer shooting is automatically canceled after one shot.

To cancel the self-timer after it starts

Press the **MENU** button.

Adjusting the brightness (Exposure compensation)

The standard brightness (appropriate exposure) set by the camera based on the shooting mode (**IAUTO** and **SCN** excluded) can be adjusted brighter or darker to obtain a desired shot.

- 1 Select the exposure compensation option in the function menu.



- 2 Use <> to select the desired brightness, and press the button.

Adjusting to a natural color scheme (White balance)

For more natural coloring, choose a white balance option suited to the scene.

- 1 Select the white balance option in the function menu.



- 2 Use \leftarrow and \rightarrow to select the setting option, and press the \odot button to set.

| Option | Description |
|--------------|---|
| WB Auto | The camera automatically adjusts the white balance according to the shooting scene. |
| Sunny | For shooting outdoors under a clear sky. |
| Cloudy | For shooting outdoors under a cloudy sky. |
| Incandescent | For shooting under tungsten lighting. |
| Fluorescent | For shooting under white fluorescent lighting (offices, etc.). |

Selecting the ISO sensitivity

- 1 Select the ISO setting option in the function menu.



- 2 Use \leftarrow and \rightarrow to select the setting option, and press the \odot button to set.

| Option | Description |
|---------------|---|
| ISO Auto | The camera automatically adjusts the sensitivity according to the shooting scene. |
| High ISO Auto | The camera uses a higher sensitivity compared to [ISO Auto] to minimize blur caused by a moving subject or by camera shake. |
| Value | The ISO sensitivity is fixed to the selected value. |







- ! "ISO" is short for "International Organization for Standardization." ISO standards specify the sensitivity for digital cameras and film, thus codes such as "ISO 100" are used to represent sensitivity.
- ! In the ISO setting, although smaller values result in less sensitivity, sharp images can be taken under fully lit conditions. Larger values result in higher sensitivity, and images can be taken at fast shutter speeds even under low light conditions. However, high sensitivity introduces noise into the resulting picture, which may give it a grainy appearance.

Sequential shooting (Drive)





Pictures are taken sequentially while the shutter button is held down.

1 Select the drive option in the function menu.



| Option | Description |
|--|---|
|  Single | One frame is shot each time the shutter button is pressed. |
|  ¹ Sequential | Take sequential shots using the focus, brightness (exposure) and white balance set in the first frame. |
|  High-Speed1 | The camera takes sequential shots at a faster speed than in  . |
|  High-Speed2 | The camera takes sequential shots at a faster speed than in  . |

¹ The shooting speed varies depending on the settings for [Image Size/Compression] (p. 34).



- ⚠ When set to , the flash (p. 30) cannot be set to [Redeye]. In addition, when set to  or , the flash is fixed to [Flash Off].
- ⚠ When set to  or , [Image Size] is limited to **[3M]** or lower, and the ISO sensitivity is fixed to [ISO Auto].

Menus for Shooting Functions

 The default settings of the function are highlighted in .

Restoring the shooting functions to the default settings [Reset]

 (Shooting menu 1) ► Reset

| Submenu 2 | Application |
|-----------|--|
| Yes | Restores the following menu functions to the default settings. <ul style="list-style-type: none"> • Shooting mode (p. 26) • Flash (p. 30) • Macro (p. 30) • Self-timer (p. 31) • Exposure compensation (p. 31) • White balance (p. 32) • ISO (p. 32) • Drive (p. 33) • Menu functions in  (Shooting menu)/ (Movie menu) (p. 34 to 37) |
| No | The current settings will not be changed. |

Selecting the image quality for still images [Image Size/Compression]

 (Shooting menu 1) ► Image Size/Compression



| Submenu 1 | Submenu 2 | Application |
|-------------|---------------------------------|---|
| Image Size | 14M (4288×3216) | Suitable for printing pictures at A3 (11×17 in.). |
| | 8M (3264×2448) | Suitable for printing pictures up to A3 (11×17 in.). |
| | 5M (2560×1920) | Suitable for printing pictures at A4 (8.5×11 in.). |
| | 3M (2048×1536) | Suitable for printing pictures up to A4 (8.5×11 in.). |
| | 2M (1600×1200) | Suitable for printing pictures at A5 (5×7 in.). |
| | 1M (1280×960) | Suitable for printing pictures at postcard size. |
| | VGA (640×480) | Suitable for viewing pictures on a TV or using pictures on emails and web sites. |
| | 16:9L (4288×2416) ^{**} | Suitable for playing pictures on a widescreen TV and for printing on A3 or 11"×17". |
| Compression | 16:9S (1920×1080) | Suitable for playing pictures on a widescreen TV and for printing on A5 or 5"×7". |
| | Fine | Shooting at high quality. |
| | Normal | Shooting at normal quality. |

^{**} VR-330/D-730 only

- ! "Number of storable pictures (still images)/Continuous recording length (movies) in the internal memory and SD/SDHC memory cards" (p. 63)

Selecting the image quality for movies [Image Size/Frame Rate]

 (Movie menu) ► Image Size/Frame Rate

| Submenu 1 | Submenu 2 | Application |
|------------|--|--|
| Image Size | 720P (1280×720)/ VGA (640×480)/ QVGA (320×240) | Select the image quality based on the image size and frame rate. Higher frame rates provide smoother movie images. |
| Frame Rate |  30fps ^{*1} /  15fps ^{*1} | |

*1 frames per second

- ! "Number of storable pictures (still images)/Continuous recording length (movies) in the internal memory and SD/SDHC memory cards" (p. 63)

Selecting the focusing area [AF Mode]



 1 (Shooting menu 1) ► AF Mode

| Submenu 2 | Application |
|-------------|--|
| Face/iESP | The camera focuses automatically. (If a face is detected, it is shown by a white frame ^{*1} ; when the shutter button is pressed halfway and the camera is able to focus, the frame color is changed to green ^{*2} if the camera is able to focus. If no face is detected, the camera chooses a subject in the frame and focuses automatically.) |
| Spot | The camera focuses on the subject located within the AF target mark. |
| AF Tracking | The camera tracks the subject movement automatically to focus on it continuously. |

*1 For some subjects, the frame may not appear or may take some time to appear.

*2 If the frame blinks in red, the camera is unable to focus. Try again to press the shutter button halfway.

To focus on a moving subject continuously (AF Tracking)

- ① Hold the camera to align the AF target mark on the subject and press the  button.
 - ② When the camera recognizes the subject, the AF target mark automatically tracks the subject movement to focus on it continuously.
 - ③ To cancel the tracking, press the  button.
- ❗ Depending on the subjects or the shooting conditions, the camera may be unable to lock the focus or fail to track the subject movement.
 - ❗ When the camera fails to track the subject movement, the AF target mark changes to red.



Shooting at higher magnifications than optical zoom [Digital Zoom]

 (Shooting menu 1) ▶ Digital Zoom

| Submenu 2 | Application |
|-----------|-----------------------|
| Off | Disable digital zoom. |
| On | Enable digital zoom. |

- ❗ [Digital Zoom] is not available when  Super Macro (p. 30) is selected.
- ❗ The option selected for [Digital Zoom] affects the appearance of the zoom bar.
“To take larger images [Digital Zoom]” (p. 21)

Reducing the blur caused by the camera shake when shooting [Image Stabilizer] (still images)/ [IS Movie Mode] (movies)

 (Shooting menu 1) ▶ Image Stabilizer (still images)/
 (Movie menu) ▶ IS Movie Mode (movies)

| Submenu 2 | Application |
|-----------|--|
| Off | The image stabilizer is deactivated. This is recommended for shooting when the camera is fixed in place on a tripod or other stable surface. |
| On | The image stabilizer is activated. |

- ❗ The camera's default settings are [Image Stabilizer] (still images) to [On] and [IS Movie Mode] (movies) to [Off].
- ❗ There may be a noise coming from inside the camera when the shutter button is pressed with [Image Stabilizer] (still images) set to [On].
- ❗ Images may not be stabilized if camera shake is too severe.
- ❗ When the shutter speed is extremely slow, such as when taking pictures at night, [Image Stabilizer] (still images) may not be as effective.
- ❗ When shooting while the [IS Movie Mode] (movies) is set to [On], the image will be enlarged somewhat before saving.

Recording sound when shooting movies [🎤]

🎤 (Movie menu) ▶ 🎤

| Submenu 2 | Application |
|-----------|-----------------------|
| Off | No sound is recorded. |
| On | Sound is recorded. |

- ⚠ When set to [On], only the digital zoom can be used during movie recording. To record the movie with the optical zoom, set [🎤] (movies) to [Off].

Using the AF illuminator to focus on a shadowed subject [AF Illuminat.]

📷 (Shooting menu 1) ▶ AF Illuminat.

| Submenu 2 | Application |
|-----------|---|
| Off | The AF illuminator is not used. |
| On | When the shutter button is pressed halfway down, the AF illuminator turns on to aid focusing. |

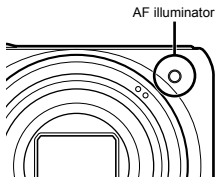

Displaying icon guides [Icon Guide]

📷 (Shooting menu 2) ▶ Icon Guide

| Submenu 2 | Application |
|-----------|---|
| Off | No icon guide is displayed. |
| On | The explanation of the selected icon will be displayed when a shooting mode or function menu icon is selected (position the cursor on the icon for a while to display the explanation). |

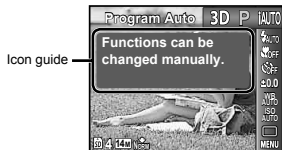

Imprinting the date of recording [Date Stamp]

📷 (Shooting menu 2) ▶ Date Stamp

| Submenu 2 | Application |
|-----------|---|
| Off | Do not imprint the date. |
| On | Stamp new photographs with the date of recording. |

- ⚠ [Date Stamp] is not available if the clock has not been set.
 "Date, time, time zone, and language" (p. 17)
- ⚠ The date stamp can not be deleted.
- ⚠ [Date Stamp] is not available in 📷 mode or during sequential shooting.

Menus for Playback, Editing, and Printing Functions

Playing back pictures automatically [Slideshow]

(Playback menu) ► Slideshow

To start a slideshow

VR-330/D-730

| Submenu 2 | Submenu 3 | Application |
|-----------|-------------------|--|
| BGM | Off/On | Selects the background music options. |
| Type | Normal/Fader/Zoom | Selects the type of transition effect used between slides. |
| Start | — | Starts the slideshow. |

- ① Select the desired [BGM] and [Type].
- ② Select [Start] and press the button.

VR-320/D-725, VR-310/D-720

Select [Slideshow] in the playback menu and press the button.

Single-frame advance/rewind

During a slideshow, press to skip ahead one frame or press to go back one frame.

To stop the slideshow

Press the button or the **MENU** button.

Changing the image size

(Playback menu) ► Edit ►

| Submenu 2 | Application |
|-----------|--|
| 640 × 480 | This saves a high-resolution image as a separate image with a smaller size for use in e-mail attachments and other applications. |
| 320 × 240 | |

- ① Use to select an image.
- ② Use to select the size, and press the button.

Cropping images

(Playback menu) ► Edit ►

- ① Use to select an image, and press the button.
- ② Use the zoom lever to select the size of the cropping frame, and use to move the frame.



- ③ Press the button.
 - The edited image will be saved as a separate image.

Adding sound to still images [U]

[▶] (Playback menu) ▶ Edit ▶ [U]

- Use ◀▶ to select an image.
- Aim the microphone toward the sound source.

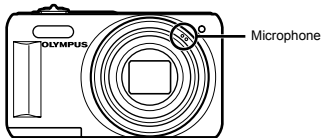

- Press the [M] button.
 - Recording starts.
 - The camera adds (records) sound for approx. 4 seconds while playing back the image.

Retouching images [Perfect Fix]

[▶] (Playback menu) ▶ Edit ▶ Perfect Fix

- Depending on the picture, the editing may not be effective.
- The retouching process may lower the image resolution.

| Submenu 1 | Application |
|--------------|---|
| All | [Lighting Fix] and [Redeye Fix] are applied together. |
| Lighting Fix | Only sections darkened by backlighting and dim lighting are brightened. |
| Redeye Fix | Eyes that are reddened by the flash are corrected. |

- Use Δ▽ to select a correction method, and press the [M] button.

- Use ◀▶ to select an image for retouching, and press the [M] button.
 - The retouched image is saved as a separate image.

Erasing images [Erase]

[▶] (Playback menu) ▶ Erase

| Submenu 1 | Application |
|------------|---|
| All Erase | All images in the internal memory or card will be erased. |
| Sel. Image | Images are individually selected and erased. |
| Erase | Deletes the image displayed. |

- When erasing pictures in a internal memory, do not insert the card into the camera.
- When erasing pictures from the card, insert a card into the camera in advance.

To erase all images [All Erase]

- Use Δ▽ to select [All Erase], and press the [M] button.
- Use Δ▽ to select [Yes], and press the [M] button.

To individually select and erase images [Sel. Image]

- Use Δ▽ to select [Sel. Image], and press the [M] button.
- Use ◀▶ to select the image to be erased, and press the [M] button to add a ✓ mark to the image.
 - Turn the zoom lever to the W side to display an index view. Images can be quickly selected using the Δ▽◀▶ buttons. Turn to the T side to return to the single frame display.

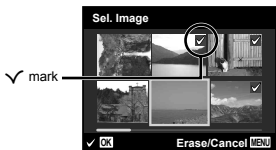

- ③ Repeat Step ② to select the images to be erased, and then press the **MENU** button to erase the selected images.
- ④ Use Δ ∇ to select [Yes], and press the \odot button.
 - The images with a \checkmark mark are erased.

Saving print settings to the image data [Print Order]

\square (Playback menu) ▶ Print Order

- ❗ "Print Reservations (DPOF)" (p. 52)
- ❗ Print reservation can be set only for still images that are recorded to the card.

Protecting images [5]

\square (Playback menu) ▶ 5

- ❗ Protected images cannot be erased by [Erase] (p. 23, 39), [Sel. Image], or [All Erase] (p. 39), but all images are erased by [Memory Format]/[Format] (p. 41).
- ① Use \triangleleft \triangleright to select an image.
 - ② Press the \odot button.
 - Press the \odot button again to cancel the settings.
 - ③ If necessary, repeat Steps ① and ② to protect other images, and press the **MENU** button.

Rotating images [↻]

\square (Playback menu) ▶ \square

- ① Use \triangleleft \triangleright to select an image.
 - ② Press the \odot button to rotate the image.
 - ③ If necessary, repeat Steps ① and ② to make settings for other images, and press the **MENU** button.
- ❗ The new picture orientations will be saved even after the power is turned off.

Menus for Other Camera Settings

Erasing data completely [Memory Format]/[Format]

Y1 (Settings 1) ► Memory Format/Format

- ! Before formatting, check that no important data is left in the internal memory or card.
- ! Cards must be formatted with this camera before first use or after being used with other cameras or computers.

| Submenu 2 | Application |
|-----------|--|
| Yes | Completely erases the image data in the internal memory ¹ or card (including protected images). |
| No | Cancels formatting. |

¹ Be sure to remove the card before formatting the internal memory.

Copying images in the internal memory to the card [Backup]

Y1 (Settings 1) ► Backup

| Submenu 2 | Application |
|-----------|---|
| Yes | Backs up image data in the internal memory to the card. |
| No | Cancels the backup. |

- ! It takes some time to back up data. Check that the battery has sufficient power before starting the backup.

Selecting a method for connecting the camera to other devices [USB Connection]

Y1 (Settings 1) ► USB Connection

| Submenu 2 | Application |
|-----------|--|
| Auto | When the camera is connected to another device, the settings selection screen is displayed. |
| Storage | Select when transferring images to a computer or when using the supplied software with the camera connected to a computer. |
| MTP | Select when transferring images to a computer running Windows Vista or Windows 7 without using the supplied software. |
| Print | Select when connecting to a PictBridge-compatible printer. |

Copying pictures to a computer without using the supplied software

This camera is compatible with the USB Mass Storage Class. You can transfer and save the image data on your computer while the camera and the computer are connected.

System requirements

| | |
|-----------|--|
| Windows | Windows XP (Service Pack 1 or later) / Windows Vista / Windows 7 |
| Macintosh | Mac OS X v10.3 or later |

 Even if a computer has USB ports, proper operation is not guaranteed in the following cases.

- computers with USB ports installed using an expansion card, etc.
- computers without a factory-installed OS and home-built computers

Turning on the camera with the button [Power On]

 (Settings 1) ►  Power On

| Submenu 2 | Application |
|-----------|---|
| No | The camera is not turned on. To turn on the camera, press the ON/OFF button. |
| Yes | Press and hold the  button to turn the camera on in playback mode. |

Saving the mode when the camera is turned off [Keep Settings]

 (Settings 1) ► Keep  Settings

| Submenu 2 | Application |
|-----------|--|
| Yes | The shooting mode is saved when the camera is turned off and is reactivated the next time the camera is turned on. |
| No | The shooting mode is set to P mode when the camera is turned on. |

Choosing the opening screen display [Pw On Setup]

 (Settings 1) ► Pw On Setup

| Submenu 2 | Application |
|-----------|---|
| Off | No opening screen is displayed. |
| On | The opening screen is displayed when the camera is turned on. |

Selecting the camera sound and its volume [Sound Settings]

 (Settings 1) ► Sound Settings

| Submenu 2 | Submenu 3 | Application |
|--|--------------------------------------|---|
| Sound Type | 1/2/3 | Choose the sound made by camera controls. |
|  Volume | OFF (No Sound) or 5 levels of volume | Adjusts the image playback volume. |
| Volume | OFF (No Sound) or 5 levels of volume | Choose the volume of the sound made by camera controls. |

Adjusting the CCD and the image processing function [Pixel Mapping]

 (Settings 2) ► Pixel Mapping

 This function has already been adjusted at factory shipping, and no adjustment is needed right after purchase. Approximately once a year is recommended.



- ! For best results, wait at least one minute after taking or viewing pictures before performing pixel mapping. If the camera is turned off during pixel mapping, be sure to perform it again.

To adjust the CCD and the image processing function

Press the  button when [Start] (Submenu 2) is displayed.

- The camera checks and adjusts the CCD and the image processing function at the same time.

Adjusting the brightness of the monitor

 (Settings 2) ► 

| Submenu 2 | Application |
|---------------|---|
| Bright/Normal | Selects the monitor brightness depending on the surrounding brightness. |

Viewing images on a TV [TV Out] (VR-330/D-730)

 (Settings 2) ► TV Out

- ! Different countries and regions use different video signal standards. Before connecting the camera, choose a video signal standard that matches that used by the TV.

| Submenu 2 | Submenu 3 | Application |
|--------------|---------------------------------|--|
| Video Out | NTSC | Choose when connecting the camera to TVs in countries or regions where NTSC is used (e.g., North America, Taiwan, Korea, and Japan). |
| | PAL | Choose when connecting the camera to TVs in countries or regions where PAL is used (e.g., Europe and China). |
| HDMI Out | 480p/576p / 720p / 1080i | Choose an HDMI output format. |
| HDMI Control | Off | Playback operations are performed using camera controls. |
| | On | Playback operations are performed using the TV remote control. |

- ! Camera factory defaults vary with the country or region of sale.

Viewing images on a TV

Using an AV cable

- ① Match the camera video signal format ((NTSC)/(PAL)) to that used by the TV.
- ② Connect the camera to the TV.

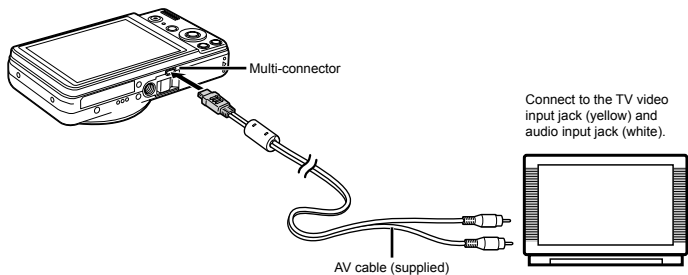

Using an HDMI cable

- 1 Match the camera digital signal format ([480p/576p]/[720p]/[1080i]) to that used by the TV.
 - 2 Connect the camera to the TV.
- ⚠ The [1080i] option gives priority to the 1080i HDMI output. If the TV is not set up for 1080i input, the camera changes the format first to 720p and if this is not supported then to 480p and finally to 576p. For information on changing TV HDMI input settings, see to the instruction manual provided with the TV.
- ⚠ Do not connect the HDMI cable when the camera is connected to a computer or other device using the USB cable.

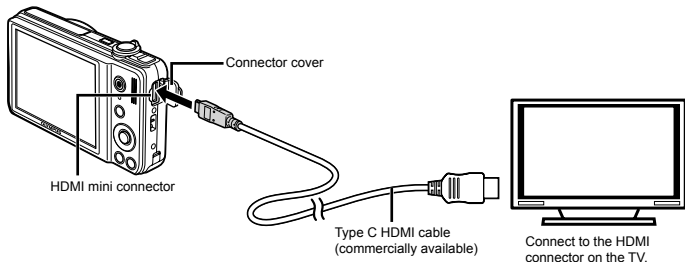

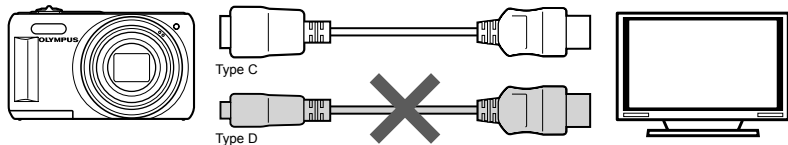

- ③ Turn the TV on and select the HDMI input to which the camera is connected.
- ⚠ See the instruction manual provided with your TV for more information.
- ④ Turn the camera on and use <|> to view images.
- ⚠ Use an HDMI cable that matches the HDMI mini connector on the camera and the HDMI connector on the TV.
- ⚠ When the camera and TV are connected by both an AV cable and an HDMI cable, the HDMI cable will take priority.
- ⚠ Images and other information may be cropped for display on the TV.

Using a remote control

- ① Select [On] for [HDMI Control] and turn the camera off.
- ② Connect the camera to the TV using an HDMI cable. "Using an HDMI cable" (p. 44)
- ③ First turn on the TV, and then turn on the camera.
 - Follow the on-screen guide displayed by the TV to operate the camera.
- ⚠ With some TVs, operations cannot be performed with the TV remote control even though the operation guide is displayed on the screen.
- ⚠ If operations cannot be performed with the TV remote control, set [HDMI Control] to [Off] and use the controls on the camera.

Selecting a video signal system to match your TV [Video Out] (VR-320/D-725, VR-310/D-720)

Y2 (Settings 2) ▶ Video Out

- ⚠ The TV video signal system varies depending on the countries and regions. Before viewing camera images on your TV, select the video output according to your TV's video signal type.

| Submenu 2 | Application |
|-----------|--|
| NTSC | Connecting the camera to a TV in North America, Taiwan, Korea, Japan, and so on. |
| PAL | Connecting the camera to a TV in European countries, China, and so on. |

- ⚠ The factory default settings differ according to the region where the camera is sold.

To play back camera images on a TV

- Use the camera to select the same video signal system as the one of connected TV ([NTSC]/[PAL]).
- Connect the TV and camera.

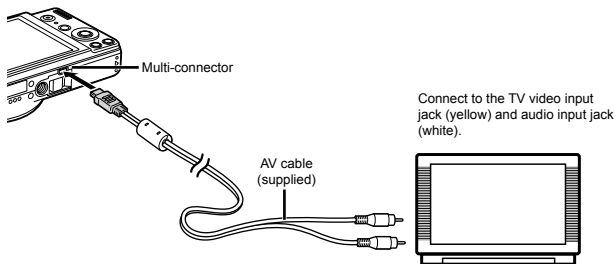

- Turn on the TV, and change "INPUT" to "VIDEO (an input jack connected to the camera)."

- ⚠ For details on changing the input source of the TV, refer to the TV's instruction manual.
- Press the button, and use to select the image for playback.
- ⚠ Depending on the TV's settings, the displayed images and information may become cropped.

Saving battery power between shots [Power Save]

F12 (Settings 2) ▶ Power Save

| Submenu 2 | Application |
|-----------|--|
| Off | Cancels [Power Save]. |
| On | When the camera is not being used for approx. 10 seconds, the monitor automatically turns off to save battery power. |

To resume standby mode

Press any button.

Changing the display language [L]

F12 (Settings 2) ▶

| Submenu 2 | Application |
|-----------|---|
| Languages | The language for the menus and error messages displayed on the monitor is selected. |

- ① Use $\Delta \nabla \triangleleft \triangleright$ to select your language and press the \odot button.

Setting the date and time [D]

F12 (Settings 2) ▶

To select the date display order

- ① Press \triangleright after setting Minute, and use $\Delta \nabla$ to select the date display order.

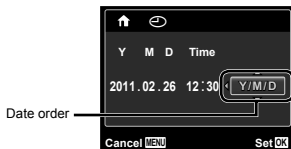

- ② Press the \odot button to complete the operation.

! "Date, time, time zone, and language" (p. 17)

Switching between home and travel destination time zones [World Time]

F12 (Settings 2) ▶ World Time

- ! You will not be able to select a time zone using [World Time] if the camera clock has not first been set using [D].

| Submenu 2 | Submenu 3 | Application |
|--------------------|-----------|---|
| Home/ Alternate | | The time in the home time zone (the time zone selected for in submenu 2). |
| | | The time in the travel destination time zone (the time selected for in submenu 2). |
| ^{*1} | — | Select the home time zone (). |
| ^{*1,2} | — | Select the travel destination time zone (). |

*1 In areas where daylight saving time is in effect, use $\Delta \nabla$ to turn daylight saving time ([Summer]) on.

*2 When you select a time zone, the camera automatically calculates the time difference between the selected zone and the home time zone () to display the time in the travel destination time zone ().

Printing

Direct printing (PictBridge¹)

By connecting the camera to a PictBridge-compatible printer, you can print images directly without using a computer.

To find out if your printer supports PictBridge, refer to the printer's instruction manual.

¹ PictBridge is a standard for connecting digital cameras and printers of different makers and printing out pictures directly.

! The printing modes, paper sizes, and other parameters that can be set with the camera vary depending on the printer that is used. For details, refer to the printer's instruction manual.

! For details on the available paper types, loading paper, and installing ink cassettes, refer to the printer's instruction manual.

Printing images at the printer's standard settings [Easy Print]

! In the setup menu, set [USB Connection] (p. 41) to [Print].

1 Display the image to be printed on the monitor.

! "Viewing images" (p. 22)

2 Turn on the printer, and then connect the printer and camera.

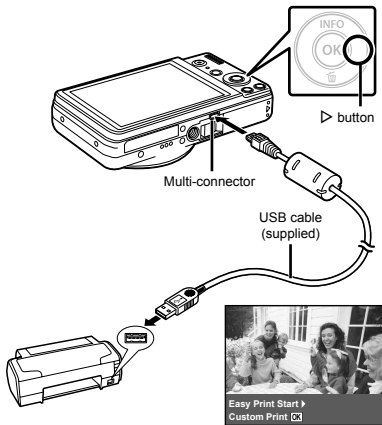

3 Press **▶** to start printing.

4 To print another image, use **◀▶** to select an image, and press the **Ⓞ** button.

To exit printing

After a selected image is displayed on the screen, disconnect the USB cable from the camera and printer.



Changing the printer's settings for printing [Custom Print]

- 1 Follow Steps 1 and 2 for [Easy Print] (p. 48), and press the **[OK]** button.
- 2 Use **△▽** to select the print mode, and press the **[OK]** button.

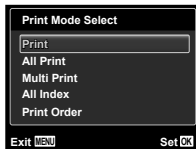

| Submenu 2 | Application |
|---------------------------|---|
| Print | This prints the image selected in Step 5. |
| All Print | This prints all images stored in the internal memory or card. |
| Multi Print | This prints one image in a multiple layout format. |
| All Index | This prints an index of all images stored in the internal memory or card. |
| Print Order ^{*1} | This prints images based on the print reservation data on the card. |

^{*1} [Print Order] is available only when print reservations have been made. "Print Reservations (DPOF)" (p. 52)

- 3 Use **△▽** to select [Size] (Submenu 3), and press **▷**.
! If the [Printpaper] screen is not displayed, the [Size], [Borderless], and [Pics/Sheet] are set to the printer's standard.

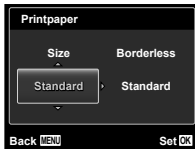

4 Use Δ ∇ to select the [Borderless] or [Pics/Sheet] settings, and press the \odot button.

| Submenu 4 | Application |
|---|--|
| Off/On ¹ | The image is printed with a border around it ([Off]). The image is printed to fill the entire paper ([On]). |
| (The number of images per sheet varies depending on the printer.) | The number of images per sheet ([Pics/Sheet]) is selectable only when [Multi Print] is selected in Step 2. |

¹ The available settings for [Borderless] vary depending on the printer.

! If [Standard] is selected in Steps 3 and 4, the image is printed at the printer's standard settings.



5 Use \triangleleft \triangleright to select an image.

6 Press Δ to make a print reservation for the current image. Press ∇ to make the detailed printer settings for the current image.

To make the detailed printer settings

① Use Δ ∇ \triangleleft \triangleright to select the setting, and press the \odot button.

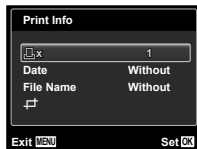

| Submenu 5 | Submenu 6 | Application |
|------------|-----------------------------------|---|
| \odot x | 0 to 10 | This selects the number of prints. |
| Date | With/Without | Selecting [With] prints the images with the date. Selecting [Without] prints the images without the date. |
| File Name | With/Without | Selecting [With] prints the file name on the image. Selecting [Without] does not print any file name on the image. |
| \boxplus | (Proceeds to the setting screen.) | This selects a portion of the image for printing. |

To crop an image [⏏]

- 1 Use the zoom lever to select the size of the cropping frame, use $\Delta \nabla \triangleleft \triangleright$ to move the frame, and then press the \odot button.



- 2 Use $\Delta \nabla$ to select [OK], and press the \odot button.

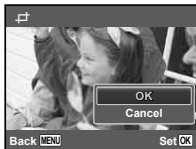

- 7 If necessary, repeat Steps 5 and 6 to select the image to be printed, make the detailed settings, and set [Single Print].

- 8 Press the \odot button.

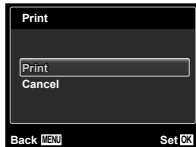

- 9 Use $\Delta \nabla$ to select [Print], and press the \odot button.

- Printing starts.
- When [Option Set] is selected in [All Print] mode, [Print Info] screen is displayed.
- When printing is finished, the [Print Mode Select] screen is displayed.

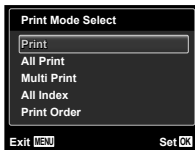

To cancel printing

- 1 When [Do Not Remove USB Cable] is displayed, press the MENU button, use $\Delta \nabla$ to select [Cancel], and then press the \odot button.

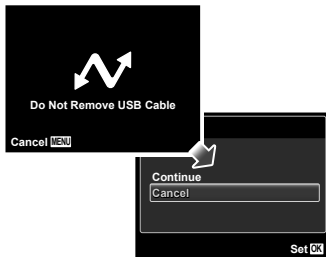

- 10 Press the MENU button.

- 11 When the message [Remove USB Cable] is displayed, disconnect the USB cable from the camera and printer.

Print Reservations (DPOF¹)

In print reservations, the number of prints and date imprint option are saved in the image on the card. This enables easy printing at a printer or print shop supporting DPOF by using only the print reservations on the card without a computer or a camera.

¹ DPOF is a standard for storing automatic printout information from digital cameras.

- ! Print reservations can be set only for the images stored on the card. Insert a card with recorded images before making print reservations.
- ! DPOF reservations set by another DPOF device cannot be changed by this camera. Make changes using the original device. Making new DPOF reservations with this camera will erase the reservations made by the other device.
- ! DPOF print reservations can be made for up to 999 images per card.

Single-frame print reservations []

1 Display the setup menu.

- ! "Using the Menu" (p. 4)

2 From the playback menu [], select [Print Order] and then press the [OK] button.

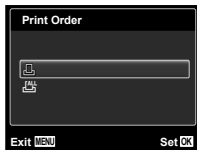

3 Use [] to select [], and press the [OK] button.



- 4** Use \triangleleft \triangleright to select the image for print reservation. Use \triangle ∇ to select the quantity. Press the \odot button.



- 5** Use \triangle ∇ to select the [Date print] screen option, and press the \odot button.

| Submenu 2 | Application |
|-----------|---|
| No | This prints the image only. |
| Date | This prints the image with the shooting date. |
| Time | This prints the image with the shooting time. |



- 6** Use \triangle ∇ to select [Set], and press the \odot button.

Reserving one print each of all images on the card [ALL]

- 1 Follow Steps 1 and 2 in [] (p. 52).
- 2 Use \triangle ∇ to select [ALL], and press the \odot button.
- 3 Follow Steps 5 and 6 in [].



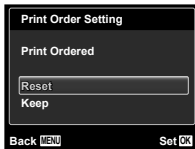

Resetting all print reservation data

- 1 Follow Steps 1 and 2 in [] (p. 52).
- 2 Use \triangle ∇ to select either [] or [ALL], and press the \odot button.



- 3 Use \triangle ∇ to select [Reset], and press the \odot button.

Resetting the print reservation data for selected images

- 1** Follow Steps 1 and 2 in [] (p. 52).
- 2** Use $\Delta \nabla$ to select [], and press the  button.
- 3** Use $\Delta \nabla$ to select [Keep] and press the  button.
- 4** Use $\langle \triangleright$ to select the image with the print reservation you want to cancel. Use $\Delta \nabla$ to set the print quantity to "0".
- 5** If necessary, repeat Step 4, and then press the  button when finished.
- 6** Use $\Delta \nabla$ to select the [] (date print) screen option, and press the  button.
 - The settings are applied to the remaining images with the print reservation data.
- 7** Use $\Delta \nabla$ to select [Set], and press the  button.

Usage Tips

If the camera does not work as intended, or if an error message is displayed on the screen, and you are unsure of what to do, refer to the information below to fix the problem(s).

Troubleshooting

Battery

“The camera does not work even when batteries are installed”.

- Insert recharged batteries in the correct direction. “Inserting the battery and the SD/SDHC memory card (sold separately)” (p. 12), “Charging the battery and setting up using the supplied CD” (p. 13), “Charging the battery with the supplied USB-AC adapter” (p. 16)
- Battery performance may have been reduced temporarily due to low temperature. Take the batteries out of the camera, and warm them by putting them in your pocket for a while.

Card/Internal memory



“An error message is displayed”.

“Error message” (p. 56)

Shutter button

“No picture is taken when the shutter button is pressed”.

- Cancel sleep mode.
To save battery power, the camera automatically goes into sleep mode and the monitor turns off if there is no operation for 3 minutes when the camera is turned on. No picture is taken even if the shutter button is fully pressed in this mode. Operate the zoom lever or other buttons to restore the camera from sleep mode before taking a picture. If the camera is left for another 12 minutes, it automatically turns off. Press the **ON/OFF** button to turn the camera on.

- Press the  button to switch to the shooting mode.
- Wait until  (flash charge) stops blinking before taking pictures.

Monitor

“Difficult to see”.

- Condensation¹ may have occurred. Turn off the power, and wait for the camera body to become acclimated to the surrounding temperature and dry out before taking pictures.
¹ Dew drops can form in the camera when it is suddenly taken from a cold location into a warm, humid room.

“Vertical lines appear on the screen”.

- This condition may occur when the camera is pointed at an extremely bright subject under a clear sky and so on. The lines do not appear, however, in the final image.

“The light is caught in the picture”.

- Shooting with flash in dark situations results in an image with many flash reflections on dust in the air.

Date and time function

“Date and time settings return to the default setting”.

- If the batteries are removed and left out of the camera for about a day², the date and time settings return to the default setting, and must be reset.
² The time until the date and time settings return to the default setting varies depending on how long the batteries have been loaded.
“Date, time, time zone, and language” (p. 17)





Miscellaneous







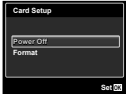
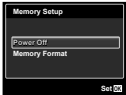

"The camera makes a noise when taking pictures".

- The camera may activate the lens and make a noise even if no operation is performed. This is because the camera automatically performs actions of auto focus as far as it is ready to shoot.

Error message

When one of the messages below is displayed on the monitor, check the corrective action.

| Error message | Corrective action |
|---|--|
|  Card Error | Card problem Insert a new card. |
|  Write Protect | Card problem The card write-protect switch is set to the "LOCK" side. Release the switch. |
|  Memory Full | Internal memory problem <ul style="list-style-type: none">• Insert a card.• Erase unwanted images.¹ |
|  Card Full | Card problem <ul style="list-style-type: none">• Replace the card.• Erase unwanted images.¹ |
|  Card Setup | Card problem Use $\Delta \nabla$ to select [Format], and press the \odot button. Next, use $\Delta \nabla$ to select [Yes], and press the \odot button. ² |
|  Memory Setup | Internal memory problem Use $\Delta \nabla$ to select [Memory Format], and press the \odot button. Next, use $\Delta \nabla$ to select [Yes], and press the \odot button. ² |

| Error message | Corrective action |
|--|---|
|  No Picture | Internal memory/Card problem Take pictures before viewing them. |
|  Picture Error | Problem with selected image Use photo retouch software, etc. to view the image on a computer. If the image still cannot be viewed, the image file is corrupted. |
|  The Image Cannot Be Edited | Problem with selected image Use photo retouch software, etc. to edit the image on a computer. |
|  Battery Empty | Battery problem Charge the battery. |
|  No Connection | Connection problem Connect the camera and computer or printer correctly. |
|  No Paper | Printer problem Load paper into the printer. |
|  No Ink | Printer problem Refill the ink in the printer. |
|  Jammed | Printer problem Remove the jammed paper. |
| Settings Changed³ | Printer problem Return to the status where the printer can be used. |
|  Print Error | Printer problem Turn off the camera and printer, check the printer for any problems, and then turn the power on again. |

| Error message | Corrective action |
|--|--|
|  Cannot Print⁴ | Problem with selected image Use a computer to print. |

- ¹ Before erasing important images, download them to a computer.
- ² All data will be erased.
- ³ This is displayed, for instance, when the printer's paper tray has been removed. Do not operate the printer while making the print settings on the camera.
- ⁴ This camera may be unable to print images taken by other cameras.

Shooting tips

When you are unsure of how to take a picture that you envision, refer to the information below.

Focusing



"Focusing on the subject"

- **Taking a picture of a subject not in the center of the screen**

After focusing on an object at the same distance as the subject, compose the shot, and take the picture.

Pressing the shutter button halfway (p. 20)

- **Set [AF Mode] (p. 35) to [Face/iESP]**
- **Taking a picture in [AF Tracking] mode (p. 35)**

The camera tracks the subject movement automatically to focus on it continuously.

- **Taking a picture of a shadowy subject**

Using the AF illuminator makes focusing easier.
 [AF Illuminat.] (p. 37)

- **Taking a picture of subjects where autofocus is difficult**

In the following cases, after focusing on an object (by pressing the shutter button halfway down) with high contrast at the same distance as the subject, compose the shot, and take the picture.

Subjects with low contrast

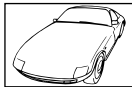

When extremely bright objects appear in the center of the screen



Object with no vertical lines¹

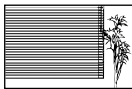

¹ It is also effective to compose the shot by holding the camera vertically to focus, and then returning to the horizontal position to take the picture.

When objects are at different distances



Fast-moving object

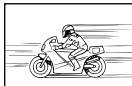

The subject is not in the center of the frame



Camera shake



“Taking pictures without camera shake”

- Taking pictures using [Image Stabilizer] (p. 36)
- Select  (Sport) in **SCN** mode (p. 26)

The  (Sport) mode uses a fast shutter speed and can reduce the blur incurred by a moving subject.

- Taking pictures at a high ISO sensitivity

If a high ISO sensitivity is selected, pictures can be taken at a high shutter speed even at locations where a flash cannot be used.

“Selecting the ISO sensitivity” (p. 32)

Exposure (brightness)



“Taking pictures with the right brightness”

- Taking pictures using [Fill In] (p. 30) flash
A subject against backlight is brightened.
- Taking pictures using exposure compensation (p. 31)

Adjust the brightness while viewing the screen for taking the picture. Normally, taking pictures of white subjects (such as snow) results in images that are darker than the actual subject. Use the exposure compensation to adjust in the positive (+) direction to express whites as they appear. When taking pictures of black subjects, on the other hand, it is effective to adjust in the negative (-) direction.

Color hue

WB

“Taking pictures with colors at the same shade as they appear”

- **Taking pictures by selecting white balance** (p. 32)

Best results in most environments can normally be obtained with the [WB Auto] setting, but for some subjects, you should try experimenting with different settings. (This is especially true for sunshade under a clear sky, mixed natural and artificial light settings, and so on.)

Image quality



“Taking sharper pictures”

- **Taking pictures with the optical zoom**
Avoid using digital zoom (p. 21, 36) to take pictures.
- **Taking pictures at a low ISO sensitivity**

If the picture is taken with a high ISO sensitivity, noise (small colored spots and color unevenness that were not in the original image) can occur, and the image can appear grainy. The resulting image is grainier than with low ISO sensitivity as well.

“Selecting the ISO sensitivity” (p. 32)

Batteries



“Making batteries last longer”

- **Avoid any of the following operations when not actually taking pictures because they deplete the battery power**
 - Repeatedly pressing the shutter button halfway
 - Repeatedly using the zoom
- **Set [Power Save] (p. 47) to [On]**

Playback/Editing tips

Playback



“Playing images in the internal memory and card”

- **Remove the card when playing pictures in the internal memory**

“To remove the SD/SDHC memory card” (p. 13)

“Viewing images with high picture quality on a high-definition TV”

- **Connect the camera to the TV using an HDMI cable (sold separately)**

“Using an HDMI cable” (p. 44)

Editing



“Erasing the sound recorded to a still image”

- **Record over the sound with silence when playing back the image**

“Adding sound to still images [🗨️]” (p. 39)

Appendix

Camera care

Exterior

- Wipe gently with a soft cloth. If the camera is very dirty, soak the cloth in mild soapy water and wring well. Wipe the camera with the damp cloth and then dry it with a dry cloth. If you have used the camera at the beach, use a cloth soaked in clean water and wrung well.

Monitor

- Wipe gently with a soft cloth.

Lens

- Blow dust off the lens with a commercial blower, then wipe gently with a lens cleaner.

⚠ Do not use strong solvents such as benzene or alcohol, or chemically treated cloth.

⚠ Mold may form on the lens surface if the lens is left dirty.

Battery/USB-AC adapter

- Wipe gently with a soft, dry cloth.

Storage

- When storing the camera for extended periods, remove the battery, USB-AC adapter and card, and keep in a cool, dry place that is well ventilated.
- Periodically insert the battery and test the camera functions.

⚠ Avoid leaving the camera in places where chemical products are handled since this may result in corrosion.

The battery and USB-AC adapter

- This camera uses one Olympus lithium ion battery (LI-42B). No other type of batteries can be used.
- ⚠ **Caution:**
There is a risk of explosion if the battery is replaced with the incorrect battery type.
Dispose of the used battery following the instructions. (p. 67)
- Power consumption by the camera varies depending on which functions are used.
- During the conditions described below, power is consumed continuously and the battery becomes exhausted quickly.
 - The zoom is used repeatedly.
 - The shutter button is pressed halfway repeatedly in shooting mode, activating the auto focus.
 - A picture is displayed on the monitor for an extended period of time.
 - The camera is connected to a printer.
- Using an exhausted battery may cause the camera to turn off without displaying the battery level warning.
- The rechargeable battery is not fully charged at the time of purchase. Use the supplied F-2AC USB-AC adapter (hereafter referred to as USB-AC adapter) to charge the battery before use.
- When the included USB-AC adapter is used, charging usually takes approximately 3 hours (varies on usage).
- The supplied USB-AC adapter is for charging and playback only. Do not take pictures while the USB-AC adapter is connected to the camera. The camera cannot playback without the battery even when connected to the USB-AC adapter.
- The included USB-AC adapter is designed to be used only with this camera. Other cameras cannot be charged with this USB-AC adapter.
Do not use with other devices.
- For plug-in type USB-AC adapter:
The included USB-AC adapter is intended to be correctly orientated in a vertical or floor mount position.

Connecting the camera to a computer

The battery can be charged by connecting the camera to a computer.

Using a separately sold charger

A charger (LI-41C: sold separately) can be used to charge the battery. In this case, remove the battery from the camera.

Using your USB-AC adapter abroad

- The USB-AC adapter can be used in most home electrical sources within the range of 100 V to 240 V AC (50/60Hz) around the world. However, depending on the country or area you are in, the AC wall outlet may be shaped differently and the USB-AC adapter may require a plug adapter to match the wall outlet. For details, ask at your local electrical shop or travel agent.
- Do not use travel voltage converters as they could damage your USB-AC adapter.

Using an SD/SDHC memory card

A card (and internal memory) also corresponds to the film that records images in a film camera. Otherwise, the recorded images (data) can be erased, and retouching is also available with the use of a computer. Cards can be removed from the camera and exchanged, but this is not possible with the internal memory. Use of larger capacity cards enables you to take more pictures.

SD/SDHC card write-protect switch

The SD/SDHC card body has a write-protect switch. If you set the switch to the "LOCK" side, you will not be able to write to the card, delete data or format. Release the switch to enable writing.

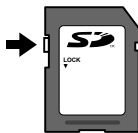

Cards compatible with this camera

SD/SDHC memory cards (visit the Olympus website for information on memory cards that have been tested and approved for use)



Using a new card

Cards must be formatted with this camera before first use or after being used with other cameras or computers.
[Memory Format]/[Format] (p. 41)

Checking the image saving location

The memory indicator shows whether the internal memory or card is being used during shooting and playback.

Current memory indicator

: Internal memory is being used

: Card is being used

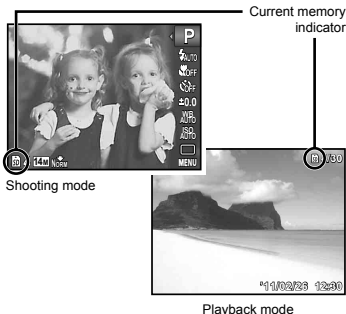

- ⚠ Even if [Memory Format]/[Format], [Erase], [Sel. Image], or [All Erase] is performed, the data in the card is not completely erased. When disposing of the card, damage the card to prevent the disclosure of personal data.

Readout/recording process of the card

During shooting, the current memory indicator lights in red while the camera is writing data. Never open the battery/card compartment cover or unplug the USB cable. This can not only damage the image data but also render the internal memory or card unusable.



Number of storable pictures (still images)/Continuous recording length (movies) in the internal memory and SD/SDHC memory cards









 The figures for the number of storable still pictures and continuous recording length are approximate. The actual capacity varies with shooting conditions and the card used.

Still images









| Image Size | Compression | Number of storable still pictures | | | |
|------------------------|-------------|-----------------------------------|------------------------------|----------------------------|------------------------------|
| | | Internal memory | | SD/SDHC memory card (1 GB) | |
| | | VR-330/D-730 | VR-320/D-725 VR-310/D-720 | VR-330/D-730 | VR-320/D-725 VR-310/D-720 |
| 14M 4288×3216 | FINE | 3 | 3 | 122 | 122 |
| | NORM | 7 | 7 | 242 | 242 |
| 8M 3264×2448 | FINE | 6 | 6 | 210 | 210 |
| | NORM | 13 | 13 | 413 | 413 |
| 5M 2560×1920 | FINE | 11 | 11 | 338 | 338 |
| | NORM | 22 | 22 | 656 | 656 |
| 3M 2048×1536 | FINE | 18 | 18 | 543 | 543 |
| | NORM | 37 | 37 | 1,078 | 1,078 |
| 2M 1600×1200 | FINE | 30 | 30 | 887 | 887 |
| | NORM | 62 | 62 | 1,776 | 1,776 |
| 1M 1280×960 | FINE | 47 | 47 | 1,372 | 1,372 |
| | NORM | 96 | 96 | 2,746 | 2,746 |
| VGA 640×480 | FINE | 194 | 194 | 5,494 | 5,494 |
| | NORM | 357 | 357 | 9,999 | 9,999 |
| 16:9S 1920×1080 | FINE | 28 | 28 | 827 | 827 |
| | NORM | 57 | 57 | 1,632 | 1,632 |

Movies

VR-330/D-730

| Image Size | Frame Rate | Continuous recording length | | | |
|--|---|-----------------------------|----------------|----------------------------|-----------------|
| | | Internal memory | | SD/SDHC memory card (1 GB) | |
| | | With sound | Without sound | With sound | Without sound |
|  1280×720 |  | 6 sec. | 6 sec. | 2 min. 50 sec. | 2 min. 51 sec. |
| |  | 12 sec. | 12 sec. | 5 min. 38 sec. | 5 min. 43 sec. |
|  640×480 |  | 17 sec. | 18 sec. | 8 min. 23 sec. | 8 min. 35 sec. |
| |  | 34 sec. | 36 sec. | 16 min. 24 sec. | 17 min. 11 sec. |
|  320×240 |  | 48 sec. | 51 sec. | 22 min. 33 sec. | 24 min. 4 sec. |
| |  | 1 min. 30 sec. | 1 min. 42 sec. | 42 min. 26 sec. | 48 min. 8 sec. |

VR-320/D-725, VR-310/D-720

| Image Size | Frame Rate | Continuous recording length | | | |
|--|---|-----------------------------|----------------|----------------------------|-----------------|
| | | Internal memory | | SD/SDHC memory card (1 GB) | |
| | | With sound | Without sound | With sound | Without sound |
|  1280×720 |  | 6 sec. | 6 sec. | 2 min. 51 sec. | 2 min. 51 sec. |
| |  | 12 sec. | 12 sec. | 5 min. 41 sec. | 5 min. 43 sec. |
|  640×480 |  | 18 sec. | 18 sec. | 8 min. 30 sec. | 8 min. 35 sec. |
| |  | 35 sec. | 36 sec. | 16 min. 49 sec. | 17 min. 11 sec. |
|  320×240 |  | 49 sec. | 51 sec. | 23 min. 22 sec. | 24 min. 4 sec. |
| |  | 1 min. 36 sec. | 1 min. 42 sec. | 45 min. 25 sec. | 48 min. 8 sec. |



 The maximum file size of a single movie is 2 GB, regardless of the capacity of the card.

Increasing the number of pictures that can be taken

Either erase unwanted images, or connect the camera to a computer or other device to save the images, and then erase the images in the internal memory or card.

[Erase] (p. 23, 39), [Sel. Image] (p. 39), [All Erase] (p. 39), [Memory Format]/[Format] (p. 41)

SAFETY PRECAUTIONS

| | | |
|--|---|---|
|  | CAUTION RISK OF ELECTRICAL SHOCK DO NOT OPEN |  |
| <p>CAUTION: TO REDUCE THE RISK OF ELECTRICAL SHOCK, DO NOT REMOVE COVER (OR BACK). NO USER-SERVICEABLE PARTS INSIDE. REFER SERVICING TO QUALIFIED OLYMPUS SERVICE PERSONNEL.</p> | | |



An exclamation mark enclosed in a triangle alerts you to important operating and maintenance instructions in the documentation provided with the product.



DANGER

If the product is used without observing the information given under this symbol, serious injury or death may result.



WARNING

If the product is used without observing the information given under this symbol, injury or death may result.



CAUTION

If the product is used without observing the information given under this symbol, minor personal injury, damage to the equipment, or loss of valuable data may result.

WARNING!

TO AVOID THE RISK OF FIRE OR ELECTRICAL SHOCK, NEVER DISASSEMBLE, EXPOSE THIS PRODUCT TO WATER OR OPERATE IN A HIGH HUMIDITY ENVIRONMENT.

General Precautions

Read All Instructions — Before you use the product, read all operating instructions. Save all manuals and documentation for future reference.

Cleaning — Always unplug this product from the wall outlet before cleaning. Use only a damp cloth for cleaning. Never use any type of liquid or aerosol cleaner, or any type of organic solvent to clean this product.

Attachments — For your safety, and to avoid damaging the product, use only accessories recommended by Olympus.

Water and Moisture — For precautions on products with weatherproof designs, read the weatherproofing sections.

Location — To avoid damage to the product, mount the product securely on a stable tripod, stand, or bracket.

Power Source — Connect this product only to the power source described on the product label.

Lightning — If a lightning storm occurs while using a USB-AC adapter, remove it from the wall outlet immediately.

Foreign Objects — To avoid personal injury, never insert a metal object into the product.

Heat — Never use or store this product near any heat source such as a radiator, heat register, stove, or any type of equipment or appliance that generates heat, including stereo amplifiers.

Handling the Camera



WARNING

- Do not use the camera near flammable or explosive gases.
- Do not use the flash and LED (such as the AF illuminator) on people (infants, small children, etc.) at close range.
 - You must be at least 1 m (3 ft.) away from the faces of your subjects. Firing the flash too close to the subject's eyes could cause a momentary loss of vision.
- Keep young children and infants away from the camera.
 - Always use and store the camera out of the reach of young children and infants to prevent the following dangerous situations which could cause serious injury:
 - Becoming entangled in the camera strap, causing strangulation.
 - Accidentally swallowing the battery, cards or other small parts.
 - Accidentally firing the flash into their own eyes or those of another child.
 - Accidentally being injured by the moving parts of the camera.
- Do not look at the sun or strong lights with the camera.
- Do not use or store the camera in dusty or humid places.
- Do not cover the flash with a hand while firing.
- Use SD/SDHC memory cards only. Never use other types of cards.

If you accidentally insert another type of card into the camera, contact an authorized distributor or service center. Do not try to remove the card by force.



CAUTION

- Stop using the camera immediately if you notice any unusual odors, noise, or smoke around it.
 - Never remove the batteries with bare hands, which may cause a fire or burn your hands.

- Never hold or operate the camera with wet hands.
- Do not leave the camera in places where it may be subject to extremely high temperatures.
 - Doing so may cause parts to deteriorate and, in some circumstances, cause the camera to catch fire.
- Do not use the USB-AC adapter if it is covered (such as a blanket). This could cause overheating, resulting in fire.
- Handle the camera with care to avoid getting a low-temperature burn.
 - When the camera contains metal parts, overheating can result in a low-temperature burn. Pay attention to the following:
 - When used for a long period, the camera will get hot. If you hold on to the camera in this state, a low-temperature burn may be caused.
 - In places subject to extremely cold temperatures, the temperature of the camera's body may be lower than the environmental temperature. If possible, wear gloves when handling the camera in cold temperatures.
- Be careful with the strap.
 - Be careful with the strap when you carry the camera. It could easily catch on stray objects and cause serious damage.

Battery Handling Precautions

Follow these important guidelines to prevent batteries from leaking, overheating, burning, exploding, or causing electrical shocks or burns.

DANGER

- The camera uses a lithium ion battery specified by Olympus. Charge the battery with the specified USB-AC adapter. Do not use any other USB-AC adapters.
- Never heat or incinerate batteries.
- Take precautions when carrying or storing batteries to prevent them from coming into contact with any metal objects such as jewelry, pins, fasteners, etc.
- Never store batteries where they will be exposed to direct sunlight, or subjected to high temperatures in a hot vehicle, near a heat source, etc.
- To prevent causing battery leaks or damaging their terminals, carefully follow all instructions regarding the use of batteries. Never attempt to disassemble a battery or modify it in any way, solder, etc.
- If battery fluid gets into your eyes, flush your eyes immediately with clear, cold running water and seek medical attention immediately.

- Always store batteries out of the reach of small children. If a child accidentally swallows a battery, seek medical attention immediately.

WARNING

- Keep batteries dry at all times.
- To prevent batteries from leaking, overheating, or causing a fire or explosion, use only batteries recommended for use with this product.
- Insert the battery carefully as described in the operating instructions.
- If rechargeable batteries have not been recharged within the specified time, stop charging them and do not use them.
- Do not use a battery if it is cracked or broken.
- If a battery leaks, becomes discolored or deformed, or becomes abnormal in any other way during operation, stop using the camera.
- If a battery leaks fluid onto your clothing or skin, remove the clothing and flush the affected area with clean, running cold water immediately. If the fluid burns your skin, seek medical attention immediately.
- Never subject batteries to strong shocks or continuous vibration.

CAUTION

- Before loading, always inspect the battery carefully for leaks, discoloration, warping, or any other abnormality.
- The battery may become hot during prolonged use. To avoid minor burns, do not remove it immediately after using the camera.
- Always unload the battery from the camera before storing the camera for a long period.

Caution for Usage Environment

- To protect the high-precision technology contained in this product, never leave the camera in the places listed below, no matter if in use or storage:
 - Places where temperatures and/or humidity are high or go through extreme changes. Direct sunlight, beaches, locked cars, or near other heat sources (stove, radiator, etc.) or humidifiers.
 - In sandy or dusty environments.
 - Near flammable items or explosives.
 - In wet places, such as bathrooms or in the rain. When using products with weatherproof designs, read their manuals as well.
 - In places prone to strong vibrations.

- Never drop the camera or subject it to severe shocks or vibrations.
- When attaching the camera to or removing it from a tripod, rotate the tripod screw, not the camera.
- Before transporting the camera, remove a tripod and all other non-OLYMPUS accessories.
- Do not touch electric contacts on cameras.
- Do not leave the camera pointed directly at the sun. This may cause lens or shutter curtain damage, color failure, ghosting on the CCD, or may possibly cause fires.
- Do not push or pull severely on the lens.
- Before storing the camera for a long period, remove the batteries. Select a cool, dry location for storage to prevent condensation or mold from forming inside the camera. After storage, test the camera by turning it on and pressing the shutter button to make sure that it is operating normally.
- The camera may malfunction if it is used in a location where it is subject to a magnetic/electromagnetic field, radio waves, or high voltage, such as near a TV set, microwave, video game, loud speakers, large monitor unit, TV/radio tower, or transmission towers. In such cases, turn the camera off and on again before further operation.
- Always observe the operating environment restrictions described in the camera's manual.

Battery Handling Precautions

- This camera uses a lithium ion battery specified by Olympus. Do not use any other type of battery.
- If the battery's terminals get wet or greasy, camera contact failure may result. Wipe the battery well with a dry cloth before use.
- Always charge a battery when using it for the first time, or if it has not been used for a long period.
- When operating the camera with battery power at low temperatures, try to keep the camera and spare battery as warm as possible. A battery that has run down at low temperatures may be restored after it is warmed at room temperature.
- The number of pictures you can take may vary depending on the shooting conditions or battery.
- Please recycle batteries to help save our planet's resources. When you throw away dead batteries, be sure to cover their terminals and always observe local laws and regulations.

LCD Monitor

- Do not push the monitor forcibly; otherwise the image may become vague, resulting in a playback mode failure or damage to the monitor.
- A strip of light may appear on the top/bottom of the monitor, but this is not a malfunction.
- When a subject is viewed diagonally in the camera, the edges may appear zigzagged on the monitor. This is not a malfunction; it will be less noticeable in playback mode.
- In places subject to low temperatures, the LCD monitor may take a long time to turn on or its color may change temporarily. When using the camera in extremely cold places, it is a good idea to occasionally place it in a warm place. An LCD monitor exhibiting poor performance due to low temperatures will recover in normal temperatures.
- The LCD used for the monitor is made with high-precision technology. However, black spots or bright spots of light may appear constantly on the LCD Monitor. Due to its characteristics or the angle at which you are viewing the monitor, the spot may not be uniform in color and brightness. This is not a malfunction.

Legal and Other Notices

- Olympus makes no representations or warranties regarding any damages, or benefit expected by using this unit lawfully, or any request from a third person, which are caused by the inappropriate use of this product.
- Olympus makes no representations or warranties regarding any damages or any benefit expected by using this unit lawfully which are caused by erasing picture data.

Disclaimer of Warranty

- Olympus makes no representations or warranties, either expressed or implied, by or concerning any content of these written materials or software, and in no event shall be liable for any implied warranty of merchantability or fitness for any particular purpose or for any consequential, incidental or indirect damages (including but not limited to damages for loss of business profits, business interruption and loss of business information) arising from the use or inability to use these written materials or software or equipment. Some countries do not allow the exclusion or limitation of liability for consequential or incidental damages or of the implied warranty, so the above limitations may not apply to you.
- Olympus reserves all rights to this manual.

Warning

Unauthorized photographing or use of copyrighted material may violate applicable copyright laws. Olympus assumes no responsibility for unauthorized photographing, use or other acts that infringe upon the rights of copyright owners.

Copyright Notice

All rights reserved. No part of these written materials or this software may be reproduced or used in any form or by any means, electronic or mechanical, including photocopying and recording or the use of any type of information storage and retrieval system, without the prior written permission of Olympus. No liability is assumed with respect to the use of the information contained in these written materials or software, or for damages resulting from the use of the information contained therein. Olympus reserves the right to alter the features and contents of this publication or software without obligation or advance notice.

FCC Notice

- Radio and Television Interference
- Changes or modifications not expressly approved by the manufacturer may void the user's authority to operate this equipment. This equipment has been tested and found to comply with the limits for a Class B digital device, pursuant to Part 15 of the FCC Rules. These limits are designed to provide reasonable protection against harmful interference in a residential installation.
- This equipment generates, uses, and can radiate radio frequency energy and, if not installed and used in accordance with the instructions, may cause harmful interference to radio communications.
- However, there is no guarantee that interference will not occur in a particular installation. If this equipment does cause harmful interference to radio or television reception, which can be determined by turning the equipment off and on, the user is encouraged to try to correct the interference by one or more of the following measures:
 - Adjust or relocate the receiving antenna.
 - Increase the distance between the camera and receiver.
 - Connect the equipment to an outlet on a circuit different from that to which the receiver is connected.
 - Consult your dealer or an experienced radio/TV technician for help. Only the OLYMPUS-supplied USB cable should be used to connect the camera to USB enabled personal computers (PC).

Any unauthorized changes or modifications to this equipment would void the user's authority to operate it.

Use Only Dedicated Rechargeable Battery and USB-AC adapter

We strongly recommend that you use only the genuine Olympus dedicated rechargeable battery and USB-AC adapter with this camera. Using a non-Olympus rechargeable battery and/or USB-AC adapter may result in fire or personal injury due to leakage, heating, ignition or damage to the battery. Olympus does not assume any liability for accidents or damage that may result from the use of a battery and/or USB-AC adapter that are not genuine Olympus accessories.

For customers in North and South America

For customers in USA

Declaration of Conformity

Model Number: VR-330/D-730
VR-320/D-725
VR-310/D-720

Trade Name: OLYMPUS

Responsible Party:

OLYMPUS IMAGING AMERICA INC.

Address: 3500 Corporate Parkway, P.O. Box 610,
Center Valley, PA 18034-0610, U.S.A.

Telephone Number: 484-896-5000

Tested To Comply With FCC Standards
FOR HOME OR OFFICE USE

This device complies with Part 15 of the FCC rules. Operation is subject to the following two conditions:

- (1) This device may not cause harmful interference.
- (2) This device must accept any interference received, including interference that may cause undesired operation.

For customers in Canada

This Class B digital apparatus complies with Canadian ICES-003.

OLYMPUS WORLDWIDE LIMITED WARRANTY - IMAGING PRODUCTS

Olympus warrants that the enclosed Olympus® imaging product(s) and related Olympus® accessories (individually a "Product" and collectively the "Products") will be free from defects in materials and workmanship under normal use and service for a period of one (1) year from the date of purchase. If any Product proves to be defective within the one-year warranty period, the customer must return the defective Product to any of Olympus Service Centers, following the procedure set forth below (See "WHAT TO DO WHEN SERVICE IS NEEDED").

Olympus, at its sole discretion, will repair, replace, or adjust the defective Product, provided that Olympus investigation and factory inspection disclose that (a) such defect developed under normal and proper use and (b) the Product is covered under this limited warranty.

Repair, replacement, or adjustment of defective Products shall be Olympus's sole obligation and the customer's sole remedy hereunder.

The customer is liable and shall pay for shipment of the Products to the Olympus Service Center.

Olympus shall not be obligated to perform preventive maintenance, installation, deinstallation, or maintenance. Olympus reserves the right to (i) use reconditioned, refurbished, and/or serviceable used parts (that meet Olympus's quality assurance standards) for warranty or any other repairs and (ii) make any internal or external design and/or feature changes on or to its products without any liability to incorporate such changes on or to the Products.

WHAT IS NOT COVERED BY THIS LIMITED WARRANTY

Excluded from this limited warranty and not warranted by Olympus in any fashion, either express, implied, or by statute, are:

- (a) products and accessories not manufactured by Olympus and/or not bearing the "OLYMPUS" brand label (the warranty coverage for products and accessories of other manufacturers, which may be distributed by Olympus, is the responsibility of the manufacturers of such products and accessories in accordance with the terms and duration of such manufacturers' warranties);
- (b) any Product which has been disassembled, repaired, tampered with, altered, changed, or modified by persons other than Olympus's own authorized service personnel unless repair by others is made with the written consent of Olympus;
- (c) defects or damage to the Products resulting from wear, tear, misuse, abuse, negligence, sand, liquids, impact, improper storage, nonperformance of scheduled operator and maintenance items, battery leakage, use of non-"OLYMPUS" brand accessories, consumables, or supplies, or use of the Products in combination with non-compatible devices;
- (d) software programs;
- (e) supplies and consumables (including but not limited to lamps, ink, paper, film, prints, negatives, cables and batteries); and/or
- (f) Products which do not contain a validly placed and recorded Olympus serial number, unless they are a model on which Olympus does not place and record serial numbers.

EXCEPT FOR THE LIMITED WARRANTY SET FORTH ABOVE, OLYMPUS MAKES NO AND DISCLAIMS ALL OTHER REPRESENTATIONS, GUARANTIES, CONDITIONS, AND WARRANTIES CONCERNING THE PRODUCTS, WHETHER DIRECT OR INDIRECT, EXPRESS OR IMPLIED, OR ARISING UNDER ANY STATUTE, ORDINANCE, COMMERCIAL USAGE OR OTHERWISE, INCLUDING BUT NOT LIMITED TO ANY WARRANTY OR REPRESENTATION AS TO THE SUITABILITY, DURABILITY, DESIGN, OPERATION, OR CONDITION OF THE PRODUCTS (OR ANY PART THEREOF) OR THE MERCHANTABILITY OF THE PRODUCTS OR THEIR FITNESS FOR A PARTICULAR PURPOSE, OR RELATING TO THE INFRINGEMENT OF ANY PATENT, COPYRIGHT, OR OTHER PROPRIETARY RIGHT USED OR INCLUDED THEREIN. IF ANY IMPLIED WARRANTIES APPLY AS A MATTER OF LAW, THEY ARE LIMITED IN DURATION TO THE LENGTH OF THIS LIMITED WARRANTY.

SOME STATES MAY NOT RECOGNIZE A DISCLAIMER OR LIMITATION OF WARRANTIES AND/OR LIMITATION OF LIABILITY SO THE ABOVE DISCLAIMERS AND EXCLUSIONS MAY NOT APPLY.

THE CUSTOMER MAY ALSO HAVE DIFFERENT AND/OR ADDITIONAL RIGHTS AND REMEDIES THAT VARY FROM STATE TO STATE.

THE CUSTOMER ACKNOWLEDGES AND AGREES THAT OLYMPUS SHALL NOT BE RESPONSIBLE FOR ANY DAMAGES THAT THE CUSTOMER MAY INCUR FROM DELAYED SHIPMENT, PRODUCT FAILURE, PRODUCT DESIGN, SELECTION, OR PRODUCTION, IMAGE OR DATA LOSS OR IMPAIRMENT OR FROM ANY OTHER CAUSE. WHETHER LIABILITY IS ASSERTED IN CONTRACT, TORT (INCLUDING NEGLIGENCE AND STRICT PRODUCT LIABILITY) OR OTHERWISE. IN NO EVENT SHALL OLYMPUS BE LIABLE FOR ANY INDIRECT, INCIDENTAL, CONSEQUENTIAL OR SPECIAL DAMAGES OF ANY KIND (INCLUDING WITHOUT LIMITATION LOSS OF PROFITS OR LOSS OF USE), WHETHER OR NOT OLYMPUS SHALL BE OR SHOULD BE AWARE OF THE POSSIBILITY OF SUCH POTENTIAL LOSS OR DAMAGE.

Representations and warranties made by any person, including but not limited to dealers, representatives, salespersons, or agents of Olympus, which are inconsistent or in conflict with or in addition to the terms of this limited warranty, shall not be binding upon Olympus unless reduced to writing and approved by an expressly authorized officer of Olympus.

This limited warranty is the complete and exclusive statement of warranty which Olympus agrees to provide with respect to the Products and it shall supersede all prior and contemporaneous oral or written agreements, understandings, proposals, and communications pertaining to the subject matter hereof.

This limited warranty is exclusively for the benefit of the original customer and cannot be transferred or assigned.

WHAT TO DO WHEN SERVICE IS NEEDED

The customer must transfer any image or other data saved on a Product to another image or data storage medium and/or remove any film from the Product prior to sending the Product to Olympus for service.

IN NO EVENT SHALL OLYMPUS BE RESPONSIBLE FOR SAVING, KEEPING OR MAINTAINING ANY IMAGE OR DATA SAVED ON A PRODUCT RECEIVED BY IT FOR SERVICE, OR ON ANY FILM CONTAINED WITHIN A PRODUCT RECEIVED BY IT FOR SERVICE, NOR SHALL OLYMPUS BE RESPONSIBLE FOR ANY DAMAGES IN THE EVENT ANY IMAGE OR DATA IS LOST OR IMPAIRED WHILE SERVICE IS BEING PERFORMED (INCLUDING, WITHOUT LIMITATION, DIRECT, INDIRECT, INCIDENTAL, CONSEQUENTIAL OR SPECIAL DAMAGES, LOSS OF PROFITS OR LOSS OF USE), WHETHER OR NOT OLYMPUS SHALL BE OR SHOULD BE AWARE OF THE POSSIBILITY OF SUCH POTENTIAL LOSS OR IMPAIRMENT.

Package the Product carefully using ample padding material to prevent damage in transit and either deliver it to the Authorized Olympus Dealer that sold you the Product or ship it postage prepaid and insured to any of our Olympus Service Centers. When returning Products for service, your package should include the following:

- 1 Sales receipt showing date and place of purchase.
- 2 Copy of this limited warranty **bearing the Product serial number corresponding to the serial number on the Product** (unless it is a model on which Olympus does not place and record serial numbers).
- 3 A detailed description of the problem.
- 4 Sample prints, negatives, digital prints (or files on disk) if available and related to the problem.

When service is completed, the Product will be returned to you postage prepaid.

WHERE TO SEND PRODUCT FOR SERVICE

See "WORLDWIDE WARRANTY" for the nearest service center.

INTERNATIONAL WARRANTY SERVICE

International warranty service is available under this warranty.

For customers in Europe



"CE" mark indicates that this product complies with the European requirements for safety, health, environment and customer protection. "CE" mark cameras are intended for sales in Europe.



This symbol [crossed-out wheeled bin WEEE Annex IV] indicates separate collection of waste electrical and electronic equipment in the EU countries.

Please do not throw the equipment into the domestic refuse.

Please use the return and collection systems available in your country for the disposal of this product.



This symbol [crossed-out wheeled bin Directive 2006/66/EC Annex II] indicates separate collection of waste batteries in the EU countries.

Please do not throw the batteries into the domestic refuse. Please use the return and collection systems available in your country for the disposal of the waste batteries.

Provisions of warranty

- 1 If this product proves to be defective, although it has been used properly (in accordance with the written Handling Care and Operating instructions supplied with it), during the applicable national warranty period and has been purchased from an authorized Olympus distributor within the business area of Olympus Europa Holding GmbH as stipulated on the website: <http://www.olympus.com> this product will be repaired, or at Olympus's option replaced, free of charge. To claim under this warranty the customer must take the product before the end of the applicable national warranty period to the dealer where the product was purchased or any other Olympus service station within the business area of Olympus Europa Holding GmbH as stipulated on the website: <http://www.olympus.com>. During the one year period of the World Wide Guarantee the customer may turn the product in at any Olympus service station. Please notice that not in all countries such Olympus service station exists.
- 2 The customer shall transport the product to the dealer or Olympus authorized service station at his own risk and shall be responsible for any costs incurred in transporting the product.

Provisions of Guarantee

- 1 *OLYMPUS IMAGING CORP., Shinjuku Monolith, 2-3-1 Nishi-Shinjuku, Shinjuku-ku, Tokyo 163-0914, Japan grants one year World Wide Guarantee. This worldwide Guarantee must be presented at an Olympus authorized repair service station before any repair can be made under conditions of this Guarantee. This Guarantee is valid only if the Guarantee Certificate and proof of purchase are presented at the Olympus repair service station. Please note that this Guarantee is in addition to and does not affect the customer's legal warranty rights under the applicable national legislation governing the sale of consumer goods mentioned above.
- 2 This Guarantee does not cover the following and the customer will be required to pay repair charge, even for defects occurring within the Guarantee period referred to above.
 - a. Any defect that occurs due to mishandling (such as an operation performed that is not mentioned in the Handling Care or other sections of the instructions, etc.)
 - b. Any defect that occurs due to repair, modification, cleaning, etc. performed by anyone other than Olympus or an Olympus authorized service station.
 - c. Any defect or damage that occurs due to transport, a fall, shock, etc. after purchase of the product.
 - d. Any defect or damage that occurs due to fire, earthquake, flood damage, thunderbolt, other natural disasters, environmental pollution and irregular voltage sources.
 - e. Any defect that occurs due to careless or improper storage (such as keeping the product under conditions of high temperature and humidity, near insect repellents such as naphthalene or harmful drugs, etc.), improper maintenance, etc.
 - f. Any defect that occurs due to exhausted batteries, etc.
 - g. Any defect that occurs due to sand, mud, etc. entering the inside of the product casing.
 - h. When the Guarantee Certificate is not returned with the product.
 - i. When any alterations whatsoever are made to the Guarantee Certificate regarding the year, month and date of purchase, the customer's name, the dealer's name, and the serial number.
 - j. When proof of purchase is not presented with this Guarantee Certificate.
- 3 This Guarantee applies to the product only; the Guarantee does not apply to any other accessory equipment, such as the case, strap, lens cap and batteries.
- 4 Olympus's sole liability under this Guarantee shall be limited to repairing or replacing the product. Any liability under the Guarantee for indirect or consequential loss or damage of any kind incurred or suffered by the customer due to a defect

of the product, and in particular any loss or damage caused to any lenses, films, other equipment or accessories used with the product or for any loss resulting from a delay in repair or loss of data, is excluded. Compelling regulations by law remain unaffected by this.

Notes regarding Guarantee maintenance

- 1 This Guarantee will only be valid if the Guarantee Certificate is duly completed by Olympus or an authorized dealer or other documents contain sufficient proof. Therefore, please make sure that your name, the name of the dealer, the serial number and the year, month and date of purchase are all completed or the original invoice or the sales receipt (indicating the dealer's name, the date of purchase and product type) is attached to this Guarantee Certificate. Olympus reserves the right to refuse free-of-charge service if neither Guarantee Certificate is completed nor the above document is attached or if the information contained in it is incomplete or illegible.
- 2 Since this Guarantee Certificate will not be re-issued, keep it in a safe place.
- * Please refer to the list on the web site: <http://www.olympus.com> for the authorized international Olympus service network.

For customers in Asia

Provisions of warranty

- 1 If this product proves to be defective, although it has been used properly (in accordance with the written Handling Care and Operating instructions supplied with it), during a period of up to one year from the date of purchase this product will be repaired, or at Olympus's option replaced, free of charge. To claim under warranty the customer must take the product and this Warranty certificate before the end of the one year warranty period to the dealer where the product was purchased or any Olympus authorized service station listed in the instructions and request the necessary repairs.
- 2 The customer shall transport the product to the dealer or Olympus authorized service station at his own risk and shall be responsible for any costs incurred in transporting the product.
- 3 This warranty does not cover the following and the customer will be required to pay repair charge, even for defects occurring within the one year period referred to above.
 - a. Any defect that occurs due to mishandling (such as an operation performed that is not mentioned in the Handling Care or other sections of the instructions, etc.)
 - b. Any defect that occurs due to repair, modification, cleaning, etc. performed by anyone other than Olympus or an Olympus authorized service station.

- c. Any defect or damage that occurs due to transport, a fall, shock, etc. after purchase of the product.
 - d. Any defect or damage that occurs due to fire, earthquake, flood damage, thunderbolt, other natural disasters, environmental pollution and irregular voltage sources.
 - e. Any defect that occurs due to careless or improper storage (such as keeping the product under conditions of high temperature and humidity, near insect repellents such as naphthalene or harmful drugs, etc.), improper maintenance, etc.
 - f. Any defect that occurs due to exhausted batteries, etc.
 - g. Any defect that occurs due to sand, mud, etc. entering the inside of the product casing.
 - h. When this Warranty Certificate is not returned with the product.
 - i. When any alterations whatsoever are made to the Warranty Certificate regarding the year, month and date of purchase, the customer's name, the dealer's name, and the serial number.
 - j. When proof of purchase is not presented with this Warranty Certificate.
- 4 This Warranty applies to the product only; the Warranty does not apply to any other accessory equipment, such as the case, strap, lens cap and batteries.
- 5 Olympus' sole liability under this warranty shall be limited to repairing or replacing the product and any liability for indirect or consequential loss or damage of any kind incurred or suffered by the customer due to a defect in the product, and in particular any loss or damage caused to any film or lenses or other equipment or accessories used with the product or for any loss resulting from delay in repair, is excluded.

Notes;

- 1 This Warranty is in addition to and does not affect the customer's statutory right.
- 2 If you have any queries regarding this Warranty, call any of the Olympus authorized service stations listed in the instructions.

Notes regarding warranty maintenance

- 1 This Warranty will only be valid if the Warranty Certificate is duly completed by Olympus or the dealer. Make sure that your name, the name of the dealer, the serial number and the year, month and date of purchase are all completed.
- 2 Since this Warranty Certificate will not be re-issued, keep it in a safe place.
- 3 Any request for repair by a customer in same country where the product was purchased shall be subject to the terms of the warranty issued by the Olympus distributor in that

country. Where the local Olympus distributor does not issue a separate warranty or where the customer is not in the country where the product was purchased the terms of this worldwide warranty shall apply.

- 4 Where applicable, this Warranty is valid worldwide. The Olympus authorized service stations listed in this Warranty will gladly honor it.
- * Please refer to the appended list for the authorized international Olympus service network.

Disclaimer of Warranty

Olympus makes no representations or warranties, either expressed or implied, by or concerning any content if these written materials or software, and in no event shall be liable for any implied warranty of merchantability or fitness for any particular purpose or for any consequential, incidental or indirect damages (including but not limited to damages for loss of business profits, business interruption and loss of business information) arising from the use of inability to use these written materials or software. Some states do not allow the exclusion or limitation of liability for consequential or incidental damages, so the above limitations may not apply to you.

Trademarks

- IBM is a registered trademark of International Business Machines Corporation.
- Microsoft and Windows are registered trademarks of Microsoft Corporation.
- Macintosh is a trademark of Apple Inc.
- SDHC logo is a trademark.
- All other company and product names are registered trademarks and/or trademarks of their respective owners.
- The standards for camera file systems referred to in this manual are the "Design rule for Camera File system/DCF" standards stipulated by the Japan Electronics and Information Technology Industries Association (JEITA).

The software in this camera may include third party software. Any third party software is subject to the terms and conditions, imposed by the owners or licensors of that software, under which such software is provided to you. Those terms and other third party software notices, if any, may be found in the software notice PDF file stored within the accompanying CD-ROM or at <http://www.olympus.co.jp/en/support/imgs/digicamera/download/notice/notice.cfm>

SPECIFICATIONS

Camera

| | VR-330/D-730 | VR-320/D-725 | VR-310/D-720 |
|----------------------------------|---|---|--|
| Product type | : Digital camera (for shooting and displaying) | | |
| Recording system | | | |
| Still pictures | : Digital recording, JPEG (in accordance with Design rule for Camera File system (DCF)) | | |
| Applicable standards | : Exif 2.2, Digital Print Order Format (DPOF), PRINT Image Matching III, PictBridge | | |
| 3D still image | : MP-format compliant | | – |
| Sound with still pictures | : Wave format | | |
| Movie | : AVI Motion JPEG | | |
| Memory | : Internal memory, SD/SDHC memory card | | |
| No. of effective pixels | : 14,000,000 pixels | | |
| Image pickup device | : 1/2.3" CCD (primary color filter) | | |
| Lens | : Olympus lens 4.2 to 52.5 mm, f3.0 to 5.9 | | Olympus lens 4.2 to 42.0 mm, f3.0 to 5.7 |
| 35 mm format equivalent | : Equivalent to 24 – 300 mm | | Equivalent to 24 – 240 mm |
| Photometric system | : Digital ESP metering system | | |
| Shutter speed | : 4 to 1/2000 sec. | | |
| Shooting range | : 0.6 m (2.0 ft.) to ∞ (W), 1.0 m (3.3 ft.) to ∞ (T) (normal) 0.2 m (0.7 ft.) to ∞ (W), 0.9 m (3.0 ft.) to ∞ (T) (macro mode) 0.01 m (0.03 ft.) to ∞ (super macro mode) | | |
| Monitor | : 3.0" TFT color LCD display, 460,000 dots | 3.0" TFT color LCD display, 230,000 dots | |
| Connector | : Multi-connector (USB connector, A/V OUT jack), HDMI mini connector (type C) | Multi-connector (USB connector, A/V OUT jack) | |
| Automatic calendar system | : 2000 up to 2099 | | |
| Operating environment | | | |
| Temperature | : 0 °C to 40 °C (32 °F to 104 °F) (operation)/-20 °C to 60 °C (-4 °F to 140 °F) (storage) | | |
| Humidity | : 30 % to 90 % (operation)/10 % to 90 % (storage) | | |
| Power supply | : One Olympus lithium ion battery (LI-42B) | | |

| | VR-330/D-730 | VR-320/D-725 | VR-310/D-720 |
|-------------------|--|---|--------------|
| Dimensions | : 100.6 mm (W) × 58.2 mm (H) × 28.1 mm (D) (4.0 × 2.3 × 1.1 in.) (excluding protrusions) | 100.6 mm (W) × 58.2 mm (H) × 28.5 mm (D) (4.0 × 2.3 × 1.1 in.) (excluding protrusions) | |
| Weight | : 153 g (5.4 oz) (including battery and card) | 158 g (5.5 oz) (including battery and card) | |

Lithium ion battery (LI-42B)

| | |
|------------------------------|---|
| Product type | : Lithium ion rechargeable battery |
| Standard voltage | : DC 3.7 V |
| Standard capacity | : 740 mAh |
| Battery life | : Approx. 300 full charges (varies on usage) |
| Operating environment | |
| Temperature | : 0°C to 40°C (32°F to 104°F) (charging)/ -10°C to 40°C (14°F to 104°F) (operation)/ -20°C to 35°C (-4°F to 95°F) (storage) |

USB-AC adapter (F-2AC)

| | |
|------------------------------|--|
| Model No. | : F-2AC-1A/F-2AC-2A/F-2AC-1B/F-2AC-2B/F-2AC-1C/F-2AC-3C/F-2AC-4C/ F-2AC-5C |
| Power requirements | : AC 100 to 240 V (50/60 Hz) |
| Output | : F-2AC-1A/F-2AC-2A/F-2AC-1B/F-2AC-2B: DC 5 V, 500 mA F-2AC-1C/F-2AC-3C/F-2AC-4C/F-2AC-5C: DC 5 V, 550 mA |
| Operating environment | |
| Temperature | : 0 °C to 40 °C (32 °F to 104 °F) (operation)/ -20 °C to 60 °C (-4 °F to 140 °F) (storage) |

Design and specifications subject to change without notice.

HDMI, the HDMI Logo and High-Definition Multimedia Interface are trademarks or registered trademarks of HDMI Licensing LLC.

HDMI™
HIGH-DEFINITION MULTIMEDIA INTERFACE

OLYMPUS KOREA CO., LTD.

10F, Olympus Tower A, 114-9, Samsung-dong, Gangnam-gu, Seoul, Korea. 135-090
<http://www.olympus.co.kr> Tel. 1544-3200

OLYMPUS (MALAYSIA) SDN. BHD.

10-6, Menara 1 MK, Kompleks '1 Mont Kiara', No.1, Jalan Kiara, Mont Kiara, 50480
Kuala Lumpur, Malaysia.
Tel:+603 6203 3882/ Fax:+603 6203 3885

BRANCHES:

PENANG OFFICE

Suite 3A-6, Level 3A, Wisma Great Eastern
No.25, Lebuhr Light, 10200 Penang
Tel:+604 262 2832/ Fax:+604 262 5832

KUCHING OFFICE

Level 6-5A, 6th Floor Menara MAA,
Lot 86, Section 53,
Jalan Central Timur,
93300 Kuching, Sarawak
Tel:+6082 253 885/ Fax:+6082 256 885

<http://www.olympus.com.my>

OLYMPUS

<http://www.olympus.com/>

OLYMPUS IMAGING CORP.

Shinjuku Monolith, 3-1 Nishi-Shinjuku 2-chome, Shinjuku-ku, Tokyo, Japan

OLYMPUS IMAGING AMERICA INC.

3500 Corporate Parkway, P.O. Box 610, Center Valley, PA 18034-0610, U.S.A. Tel. 484-896-5000

Technical Support (USA)

24/7 online automated help:

<http://www.olympusamerica.com/support>

Phone customer support: Tel. 1-888-553-4448 (Toll-free)

Our phone customer support is available from 9 am to 9 pm
(Monday to Friday) ET

<http://olympusamerica.com/contactus>

Olympus software updates can be obtained at:

<http://www.olympusamerica.com/digital>

OLYMPUS EUROPA HOLDING GMBH

Premises: Wendenstrasse 14-18, 20097 Hamburg, Germany
Tel: +49 40-23 77 3-0 / Fax: +49 40-23 07 61

Goods delivery: Bredowstrasse 20, 22113 Hamburg, Germany
Letters: Postfach 10 49 08, 20034 Hamburg, Germany

European Technical Customer Support:

Please visit our homepage <http://www.olympus-europa.com> or call our TOLL FREE NUMBER* : **00800 - 67 10 83 00**
for Austria, Belgium, Denmark, Finland, France, Germany, Italy, Luxembourg, Netherlands, Norway, Portugal, Spain, Sweden, Switzerland, United Kingdom
* Please note some (mobile) phone services providers do not permit access or request an additional prefix to +800 numbers.

For all European Countries not listed and in case that you can't get connected to the above mentioned number, please make use of the following
CHARGED NUMBERS: **+49 180 5 - 67 10 83** or **+49 40 - 237 73 4899**

Our Technical Customer Support is available from 9 am to 6 pm MET (Monday to Friday)

OLYMPUS IMAGING CHINA CO.,LTD.

Customer Support: 400-650-0303 Homepage: <http://www.olympus.com.cn>

Customer Service Center:

A8F, Ping An International Financial Center, No. 1-3,
Xinyuan South Road, Chaoyang District, Beijing
Tel: +86-10-58199199 Fax: +86-10-59761360 Zip: 100027

A,32F Shanghai Industrial Investment Building 18
Cao Xi Road(N), Xuhui District, Shanghai
Tel: +86-21-60823500 Fax: +86-21-60823100 Zip: 200030

Rm.1605-1608, Guangzhou International Electronic tower, No403,
Huan Shi East Road, Guang Zhou
Tel: +86-20-61227111 Fax: +86-20-61227120 Zip: 510095

16F Huamin Hanzun Internation Plaza, No.1, Fuxing Street,
Chengdu
Tel: +86-28-86703531 Fax: +86-28-86703532 Zip: 610016

OLYMPUS HONG KONG AND CHINA LIMITED

Digital Camera Repair Centre
L4207, Office Tower, Langham Place, 8 Argyle Street, Mongkok, Kowloon, Hong Kong
Customer Hotline: +852-2376-2150 Fax: +852-2375-0630
<http://www.olympus.com.hk>